

EPM7-1V

1 Watt isolated DC-DC converter



Product features

- 1 Watt isolated DC-DC converter
- Input voltage: 5 Vdc, 12 Vdc, and 24 Vdc
- Efficiency up to 82%
- Isolation voltage: 4 kVdc
- SIP7 (4 and 5 pin) package
- Operating ambient temperature from -40 °C to +100 °C
- No minimum load required
- IEC62368-1/ EN55032&35 certified

Applications

- Computing/telecom
- Distributed power architectures
- Servers and workstations
- LAN / WAN applications
- Data processing applications
- Industrial IoT equipment, sensors
- Power supply, battery backup
- Wireless TX/RX modules
- Renewable energy products

Environmental compliance



Ordering part number

	<u>EPM</u>	<u>7</u>	<u>05</u>	<u>1V</u>	<u>3R3</u>	<u>303</u>	<u>S</u>	<u>H</u>
Eaton converter	_____	_____	_____	_____	_____	_____	_____	_____
Package type/size code	_____	_____	_____	_____	_____	_____	_____	_____
Maximum rated input voltage	_____	_____	_____	_____	_____	_____	_____	_____
Version code	_____	_____	_____	_____	_____	_____	_____	_____
Output voltage (maximum, R=decimal point)	_____	_____	_____	_____	_____	_____	_____	_____
Output current (maximum, in mA)	_____	_____	_____	_____	_____	_____	_____	_____
S = single output, D = dual output	_____	_____	_____	_____	_____	_____	_____	_____
H= Higher isolation voltage	_____	_____	_____	_____	_____	_____	_____	_____



Powering Business Worldwide



Specifications

	Parameter	Conditions	Minimum	Typical	Maximum	Unit	
Input	Input filter			Internal capacitors			
	Input voltage range		-10		+10	%	
Output	Efficiency			Selection guide			
	Minimum load		0			%	
	Line regulation	LL-HL at 100% load		1.2% typ. @1% of Vin			
	Load regulation (10-100% Load)	Vout = 3.3 Vdc, 5 Vdc			15		%
		Vout = 12 Vdc, 15 Vdc			10		%
	Voltage accuracy		-5		+5	%	
	Operating frequency	100% Load at Nominal Vin	50				kHz
Ripple & noise ¹					100	mVp-p	
Environment	Operating temperature (with derating)		-40		+100	°C	
	Storage temperature		-55		+125	°C	
	Relative humidity		5		95	%RH	
	Vibration			MIL-STD-202G			
Function	Isolation voltage 1 min., Input to Output		4			kVdc	
	Isolation resistance		10			GΩ	
	Isolation capacitance			80		pF	
	MTBF (MIL-HDBK-217F)	+25 °C			17,100		khours
		+85 °C			10,400		khours
Certification				IEC62368-1/ EN55032&35			
Physical	Dimension			0.774 x 0.402 x 0.278 inch			
	Weight			2.8 g			
	Case material			UL94V-0 black plastic			
	Potting material			Epoxy (UL94V-0)			
EMC	EMI	EN 55032		Class A/B with external circuit			
	ESD	IEC 61000-4-2 Air ± 8 kV; Contact ± 6 kV		Criteria A			
	RS	IEC 61000-4-3, 3 V/m		Criteria A			
	EFT	IEC 61000-4-4, ± 0.5 kV		Criteria A			
	Surge	IEC 61000-4-5, ± 0.5 kV		Criteria A			
	CS	IEC 61000-4-6, 3 Vrms		Criteria A			
	PFMF	IEC 61000-4-8, 1 A/m		Criteria A			

1. The ripple & noise are measured with 0.1 µF capacitor at 20 MHz BW.

2. All specifications valid at nominal input, full load and +25 °C after warm-up time unless otherwise stated.

3. The product information and specifications are subject to change without prior notice.

Selection guide

Part number	Input voltage (Vdc)	Output voltage (Vdc)	Output current @ full load (mA)	Efficiency ¹ minimum	Efficiency ¹ typical	Capacitive load ² maximum (μF)
EPM7051V-3R3-303SH	5	3.3	303	71%	74%	1500
EPM7051V-05R-200SH	5	5	200	76%	79%	1500
EPM7051V-12R-084SH	5	12	84	75%	78%	470
EPM7051V-15R-067SH	5	15	67	82%	85%	220
EPM7051V-3R3-152DH	5	±3.3	±152	72%	75%	±470
EPM7051V-05R-100DH	5	±5	±100	74%	77%	±470
EPM7051V-12R-042DH	5	±12	±42	77%	80%	±220
EPM7051V-15R-034DH	5	±15	±34	77%	80%	±220
EPM7121V-3R3-303SH	12	3.3	303	76%	79%	1500
EPM7121V-05R-200SH	12	5	200	79%	82%	1500
EPM7121V-12R-084SH	12	12	84	77%	80%	470
EPM7121V-15R-067SH	12	15	67	78%	81%	220
EPM7121V-3R3-152DH	12	±3.3	±152	77%	80%	±470
EPM7121V-05R-100DH	12	±5	±100	73%	76%	±470
EPM7121V-12R-042DH	12	±12	±42	77%	80%	±220
EPM7121V-15R-034DH	12	±15	±34	78%	81%	±220
EPM7241V-3R3-303SH	24	3.3	303	75%	78%	1500
EPM7241V-05R-200SH	24	5	200	76%	79%	1500
EPM7241V-12R-084SH	24	12	84	76%	79%	470
EPM7241V-15R-067SH	24	15	67	77%	80%	220
EPM7241V-3R3-152DH	24	±3.3	±152	73%	76%	±470
EPM7241V-05R-100DH	24	±5	±100	77%	80%	±470
EPM7241V-12R-042DH	24	±12	±42	77%	80%	±220
EPM7241V-15R-034DH	24	±15	±34	78%	81%	±220

1. Efficiency is nominal input voltage and full load @ +25 °C.
2. Capacitive load is tested at minimum input voltage and a constant resistive load.
3. All specifications valid at nominal input voltage, full load and +25 °C after warm-up time unless otherwise stated.

Derating curve

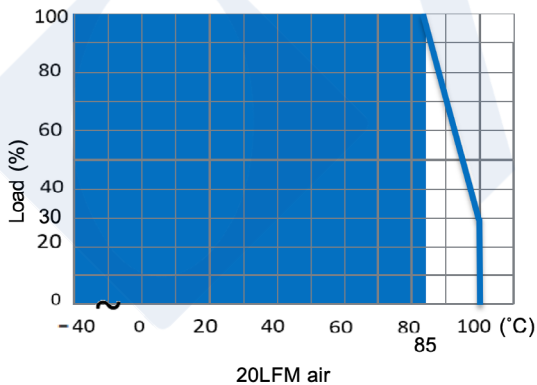

Measure method

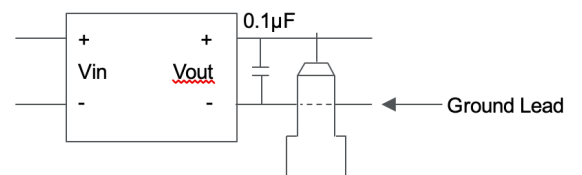

EMC filtering circuit

Single

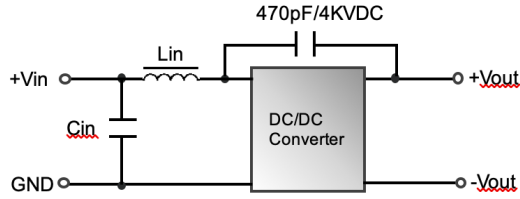

Class	5 Vin	12 Vin	24 Vin
Class A	47 μ H/ 2.2 μ F	22 μ H/ 2.2 μ F	10 μ H/ 2.2 μ F
Class B	47 μ H/ 10 μ F	22 μ H/ 4.7 μ F	22 μ H/ 4.7 μ F

Dual

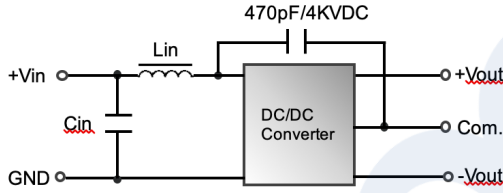

Class	5 Vin	12 Vin	24 Vin
Class A	22 μ H/ 2.2 μ F	22 μ H/ 2.2 μ F	10 μ H/ 2.2 μ F
Class B	100 μ H/ 4.7 μ F	22 μ H/ 4.7 μ F	47 μ H/ 2.2 μ F

Dimensions - inches

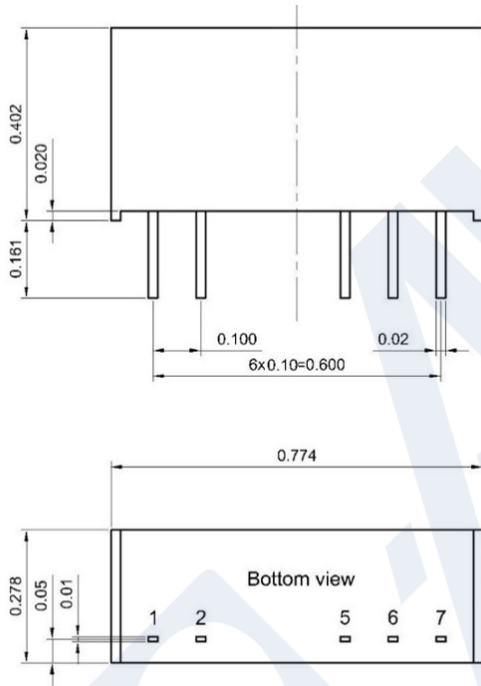

Projection: Third angle projection
Unit: inch
PIN tolerance: ± 0.004
Tolerance: X.XX ± 0.02 X.XXX ± 0.01

Recommended PCB layout

Single

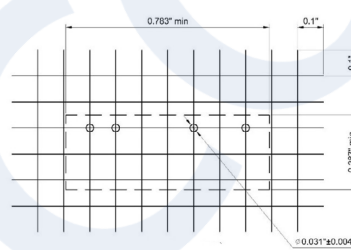

Dual

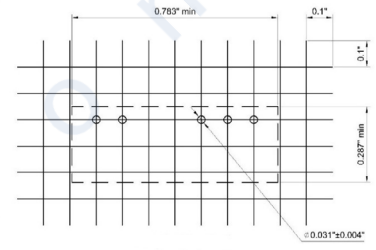

Marking



WLY = lot code

Pin	Single	Dual
1	+Vin	+Vin
2	-Vin	-Vin
5	-Vout	-Vout
6	No pin	Common
7	+Vout	+Vout

Packaging- Inches

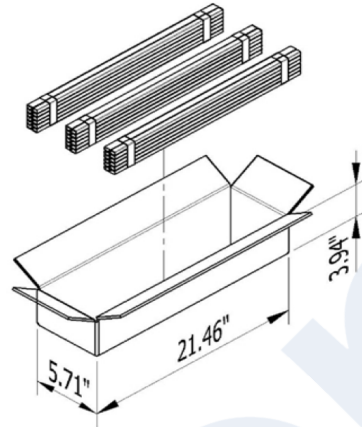
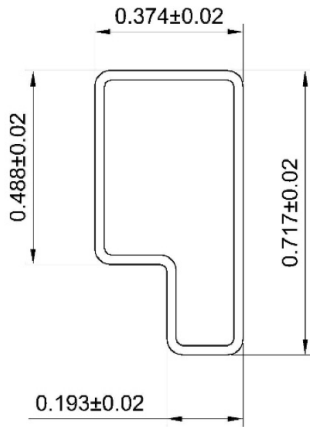

Unit: inch
1 tube = 25 pieces
Length: 20.47 ± 0.08

Carton = $21.46 * 5.71 * 3.94$ inch
 25 (pieces/tube) * 12 (tube/bundle) * 3 (bundle) = 900 pieces

General information

Storage and handling

The shelf life will be a minimum of 36 months, when stored at the following conditions: < +40 °C, < 90% RH.

Wave solder profile

The wave solder profile is measured based on lead temperature. The recommended PCB pre-heat temperature is +80 °C to +100 °C, and the preheat rate of 1.5 to 2.5 °C/sec. The underside PCB temperature at the last pre-heat zone should be approximately +150 °C. The internal temperature of the solder parts should not exceed +210 °C. The duration of solder dwell time should be between 3 to 5 seconds, and not to exceed 10 seconds at a temperature of +260 °C maximum.

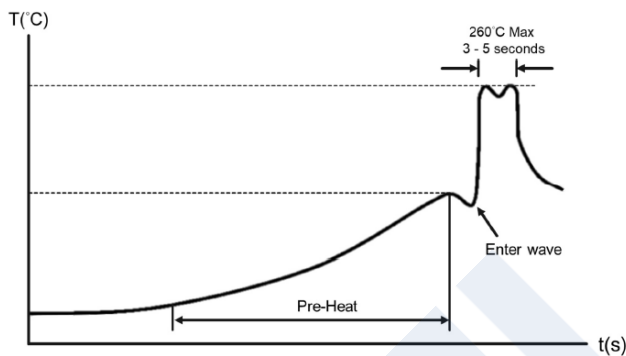

Life Support Policy: Eaton does not authorize the use of any of its products for use in life support devices or systems without the express written approval of an officer of the Company. Life support systems are devices which support or sustain life, and whose failure to perform, when properly used in accordance with instructions for use provided in the labeling, can be reasonably expected to result in significant injury to the user.

Eaton reserves the right, without notice, to change design or construction of any products and to discontinue or limit distribution of any products. Eaton also reserves the right to change or update, without notice, any technical information contained in this bulletin.

Eaton
Electronics Division
1000 Eaton Boulevard
Cleveland, OH 44122
United States
www.eaton.com/electronics

© 2022 Eaton
All Rights Reserved
Printed in USA
Publication No. ELX1164 BU-ELX22023
March 2022

Eaton is a registered trademark.

All other trademarks are property of their respective owners.

Follow us on social media to get the latest product and support information.

