

ECSTA1V0703

Automotive grade SMT current sense transformer



Product features

- AEC-Q200 qualified
- EE4.6 SMT package (7.2 mm x 5.2 mm x 3.0 mm)
- Very low DC resistance
- Wide selection of turns ratios
- Sensed current – primary rated for 9 A
- Frequency range: 50 kHz to 1 MHz
- Moisture sensitivity level (MSL): 1

Applications

- Motor drive
- On-board chargers
- DC/DC converters
- Wireless chargers
- Battery management systems (BMS)
- EV charging
- Feedback control
- Overload sensing

Environmental compliance and general specifications

- Storage temperature (component): -40 °C to +125 °C
- Operating temperature range: -40 °C to +125 °C (ambient plus self-temperature rise)
- Solder reflow temperature: J-STD-020 (latest revision) compliant



Powering Business Worldwide



Product specifications

Part number ³	Turns ratio sec :pri	Secondary inductance (mH) @ 100 kHz 0.1 V minimum	DCR sec (Ω) maximum	DCR pri (m Ω) reference	Hi-pot pri to sec @ 2 mA 3 seconds 50 Hz	Sensed current ¹ (A) maximum
ECSTA1V0703-1020-R	20:1	0.053	0.42	1.5	500 Vac	9
ECSTA1V0703-1050-R	50:1	0.333	2.76	1.5	500 Vac	9
ECSTA1V0703-1070-R	70:1	0.652	5.04	1.5	500 Vac	9
ECSTA1V0703-1100-R	100:1	1.33	10.68	1.5	500 Vac	9
ECSTA1V0703-1150-R	150:1	2.993	22.3	1.5	500 Vac	9

1. Primary current of 9 A causes less than 40°C temperature rise @ +2.5°C ambient. Higher current causes a greater temperature rise

2. Electrical specifications at +25 °C

3. Part Number Definition: ECSTA1V0703-1xxx-R

ECSTA1V0703 = Product code and size

1xxx= Turns ratio sec:pri 1=pri, xxx=sec; 1020= 20:1

-R suffix = RoHS compliant

Mechanical parameters, schematic, pad layout (mm)

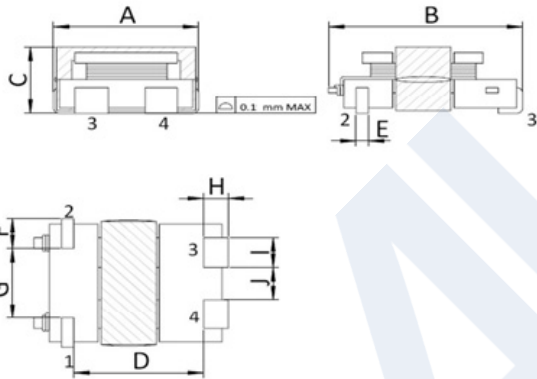

Recommended PCB Layout

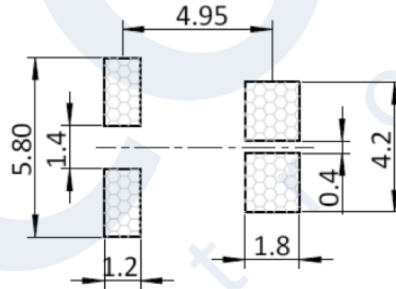

Schematic

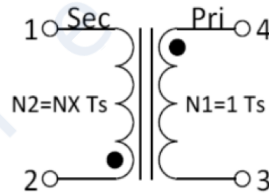

Dimension	Value
A	5.20 maximum
B	7.20 maximum
C	3.00 maximum
D	4.05
E	0.4
F	1.1
G	2.6
H	1.2
I	1.1
J	1.2

Part marking: White dot, Pin 2 indicator

All soldering surfaces to be coplanar within 0.1 millimeters

Tolerances are ±0.1 millimeters unless stated otherwise

Traces or vias underneath the inductor is not recommended

Temperature rise vs current

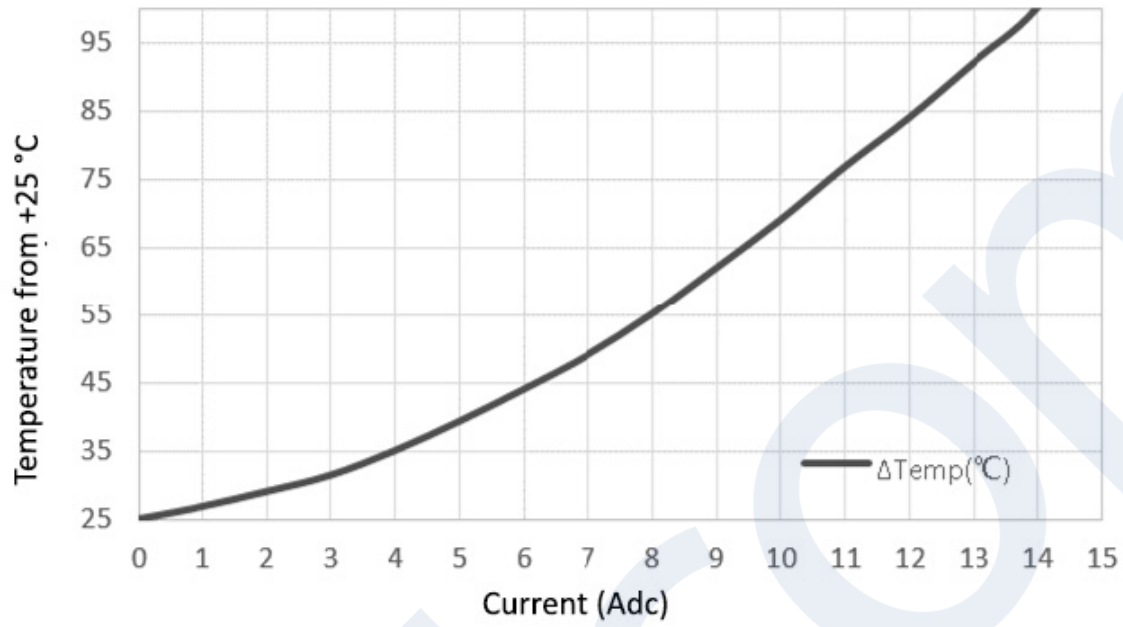

Packaging information (mm)

Supplied in tape and reel packaging, 13" diameter reel (EIA-481 compliant)
2500 parts per reel

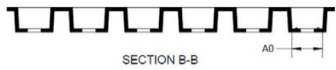
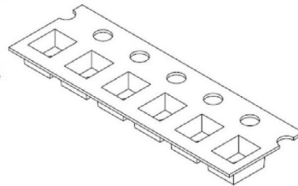
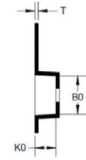
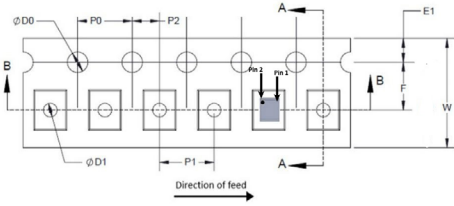

Dimension	Value
W	16.0 ±0.3
P1	8.0 ±0.1
E1	1.75 ±0.1
F	7.5 ±0.05
P2	2.0 ±0.05
D0	1.5 +0.1/-0
D1	1.5 +0.1/-0
B0	7.2 ±0.1
A0	5.2 ±0.1
K0	2.9 ±0.1
P0	4.0 ±0.1
T	0.35 ±0.05

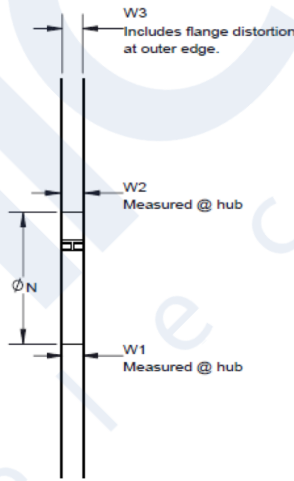
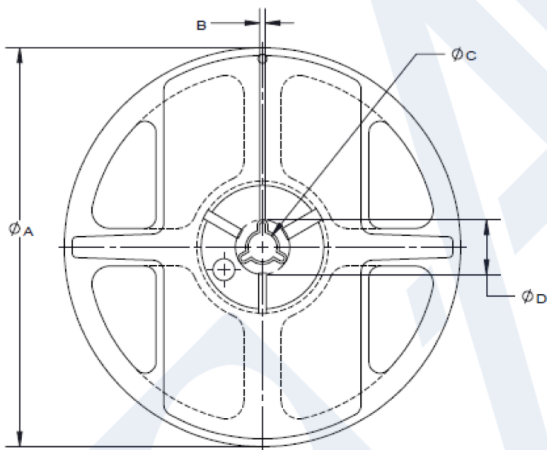

Dimension	Value
A	330 ±3.0
B	2.6 ±0.3
N	100 ±1.0
C	13+0.5/-0.2
D	21.5 ±0.5
W1	16.4 +2.0/-0.0
W2	22.4 max
W3	na

Solder reflow profile

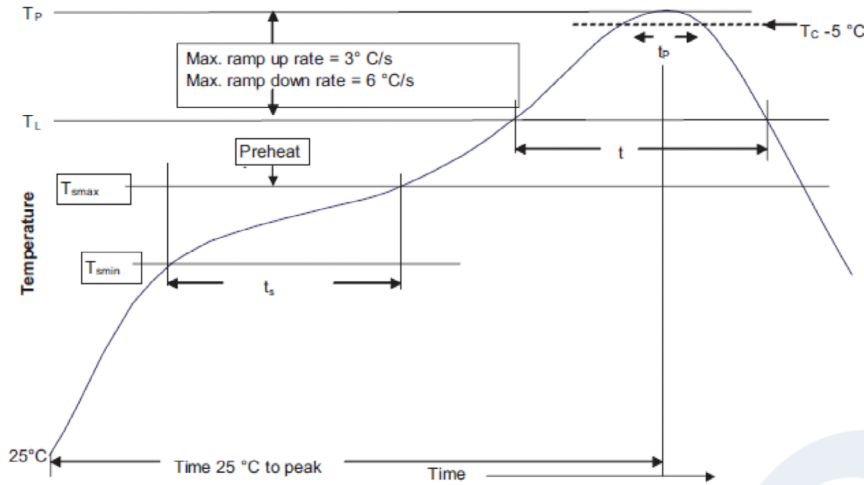

Table 1 - Standard SnPb solder (T_c)

Package Thickness	Volume mm ³ <350	Volume mm ³ ≥350
<2.5 mm)	235 °C	220 °C
≥2.5 mm	220 °C	220 °C

Table 2 - Lead (Pb) free solder (T_c)

Package thickness	Volume mm ³ <350	Volume mm ³ 350 - 2000	Volume mm ³ >2000
<1.6 mm	260 °C	260 °C	260 °C
1.6 – 2.5 mm	260 °C	250 °C	245 °C
>2.5 mm	250 °C	245 °C	245 °C

Reference J-STD-020

Profile feature	Standard SnPb solder	Lead (Pb) free solder
Preheat and soak		
• Temperature min. (T_{smin})	100 °C	150 °C
• Temperature max. (T_{smax})	150 °C	200 °C
• Time (T_{smin} to T_{smax}) (t_s)	60-120 seconds	60-120 seconds
Ramp up rate T_L to T_p	3 °C/ second max.	3 °C/ second max.
Liquidous temperature (T_L)	183 °C	217 °C
Time (t_L) maintained above T_L	60-150 seconds	60-150 seconds
Peak package body temperature (T_p)*	Table 1	Table 2
Time (t_p)* within 5 °C of the specified classification temperature (T_c)	20 seconds*	30 seconds*
Ramp-down rate (T_p to T_L)	6 °C/ second max.	6 °C/ second max.
Time 25 °C to peak temperature	6 minutes max.	8 minutes max.

* Tolerance for peak profile temperature (T_p) is defined as a supplier minimum and a user maximum.

Manual solder

30 W soldering iron. +350 °C ±10 °C, 3 seconds maximum. Do not touch product with iron. Generally manual, hand soldering is not recommended.

Life Support Policy: Eaton does not authorize the use of any of its products for use in life support devices or systems without the express written approval of an officer of the Company. Life support systems are devices which support or sustain life, and whose failure to perform, when properly used in accordance with instructions for use provided in the labeling, can be reasonably expected to result in significant injury to the user.

Eaton reserves the right, without notice, to change design or construction of any products and to discontinue or limit distribution of any products. Eaton also reserves the right to change or update, without notice, any technical information contained in this bulletin.

Eaton
Electronics Division
1000 Eaton Boulevard
Cleveland, OH 44122
United States
Eaton.com/electronics

© 2022 Eaton
All Rights Reserved
Printed in USA
Publication No. ELX1190 BU-ELX22050
2022

Eaton is a registered trademark.

All other trademarks are property of their respective owners.

Follow us on social media to get the latest product and support information.

