

ECMT1V20

Common mode choke, through-hole

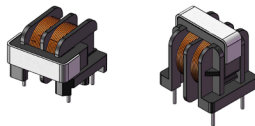

Product features

- Closed magnetic path reduces conductive EMI emission
- High impedance and inductance values
- Robust construction
- High voltage isolation
- Independent winding sections
- Rated voltage: 250 Vac

Applications

- Industrial IoT equipment
- Motion controls
- Power supplies
- Battery backup
- Renewable energy products
- Smart meters
- Solar/wind generators, inverters, charger controllers
- Medical equipment
- High tech consumer products
- Appliances

Environmental compliance and general specifications

- Storage temperature range (Component): -40 °C to +85 °C
- Operating temperature range: -40 °C to +125 °C (ambient plus self-temperature rise)
- Wave solder temperature: +260 °C maximum



Powering Business Worldwide



Singel 3 | B-2550 Kontich | Belgium | Tel. +32 (0)3 458 30 33 | info@alcom.be | www.alcom.be
 Rivium 1e straat 52 | 2909 LE Capelle aan den IJssel | The Netherlands | Tel. +31 (0)10 288 25 00 | info@alcom.nl | www.alcom.nl

Product specifications

Part number ⁷	OCL ¹ (mH) minimum (1-2), (4-3)	DCR ² (Ω) maximum (1-2), (4-3) @ +25 °C	I _{rms} ³ (A) (1-4) short 2,3	SRF (kHz) minimum	Hi-pot ⁴ (Vac)	Hi-pot ⁵ (Vac)	Insulation resistance ⁶ (MΩ) minimum
ECMT1V2023S-2R0-R	2.0	0.08	1.5	976	1500	1000	100
ECMT1V2017H-2R0-R	2.0	0.08	1.5	976	1500	1000	100
ECMT1V2023S-200-R	20	0.55	1.0	245	1500	1000	100
ECMT1V2017H-200-R	20	0.55	1.0	245	1500	1000	100
ECMT1V2023S-300-R	30	0.9	0.8	160	1500	1000	100
ECMT1V2017H-300-R	30	0.9	0.8	160	1500	1000	100
ECMT1V2023S-600-R	60	2.1	0.4	96	1500	1000	100
ECMT1V2017H-600-R	60	2.1	0.4	96	1500	1000	100

1. Open circuit inductance (OCL) Test parameters: 1 kHz, 0.25 Vrms, 0.0 Adc, +25 °C

2. DCR Test parameters: 4-wire method measured from the root of base, +25 °C

3. I_{rms}³: Maximum DC current for an approximate temperature rise of 40 °C without core loss. Derating is necessary for AC currents. PCB layout, trace thickness and width, air-flow, and proximity of other heat generating components will affect the temperature rise. It is recommended that the temperature of the part not exceed +125 °C under worst case operating conditions verified in the end application.

4. Hi-pot: Coil-Coil, 2 seconds, 5 mA

5. Hi-pot: Coil-Core, 2 seconds, 5 mA

6. Insulation Resistance: Coil-Coil and Coil-Core, at 500 Vdc

7. Part Number Definition: ECMT1Vxxxxy-zzz-R

ECMT1V = Product code

xxxx= Size indicator

y= Orientation H= horizontal, S= vertical

zzz=Inductance value in mH, R= decimal point, If no R is present last digit indicates number of zeros

-R= RoHS compliant

Mechanical parameters, schematic, pad layout (mm)

ECMT1V2023S-xxx-R

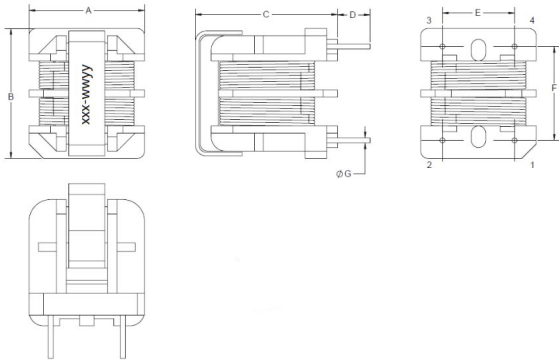

Recommended PCB layout

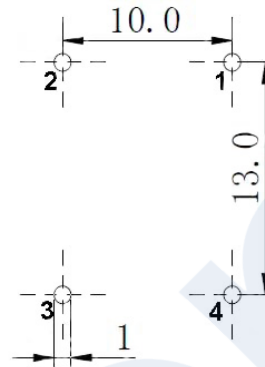

Schematic

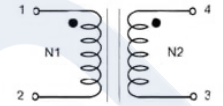

ECMT1V2017H-xxx-R

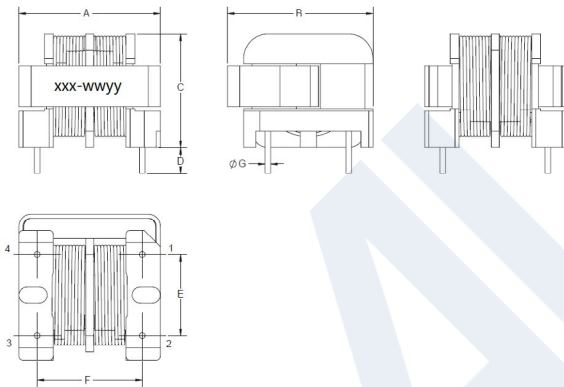

Recommended PCB layout

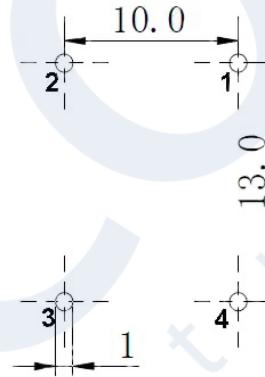

Schematic

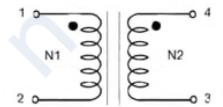

Part number	A	B	C	D	E	F	G
ECMT1V2023S-xxx-R	17.5 max.	20.0 max.	23.0 max.	3.5 ± 0.5	10.0 ± 0.5	13.0 ± 0.5	0.7 ± 0.1
ECMT1V2017H-xxx-R	19.5 max.	19.5 max.	17.0 max.	3.5 ± 0.5	10.0 ± 0.5	13.0 ± 0.5	0.7 ± 0.1

Part marking: xxx-wyyy, xxx = inductance value in mH, wyyy = lot code
Traces or vias underneath the inductor is not recommended

Packaging information (mm)

ECMT1V2023S-xxx-R

Supplied in tray, 10 trays per carton. (81 parts per tray x 10 trays per box = 810 parts per carton)

(Tray height 22 mm)

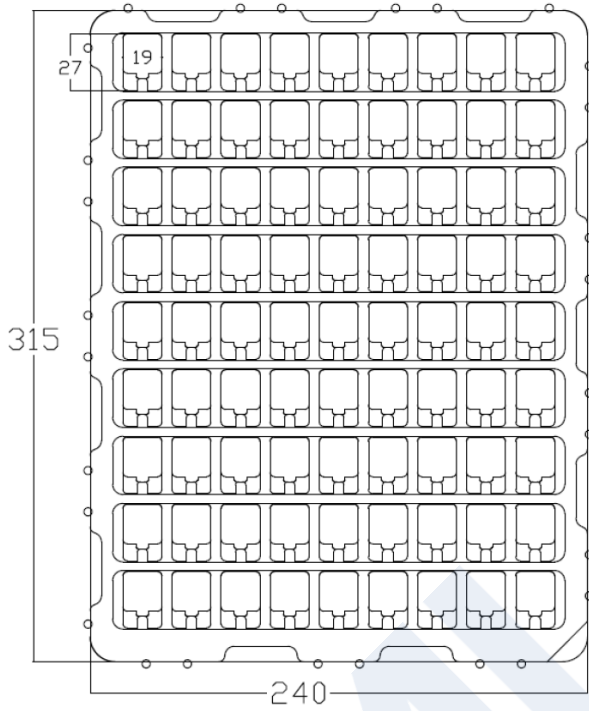

ECMT1V2017H-xxx-R

Supplied in tray, 10 trays per carton. (99 parts per tray x 10 trays per box = 990 parts per carton)

(Tray height 24 mm)

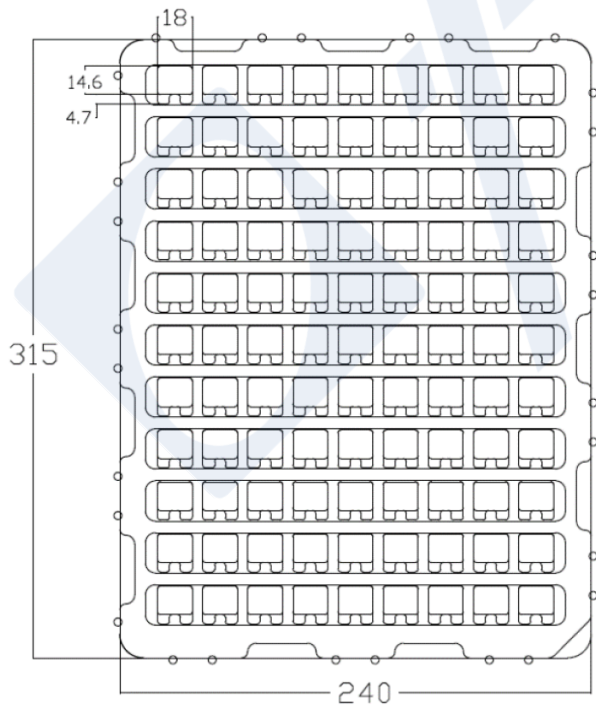

Impedance vs frequency

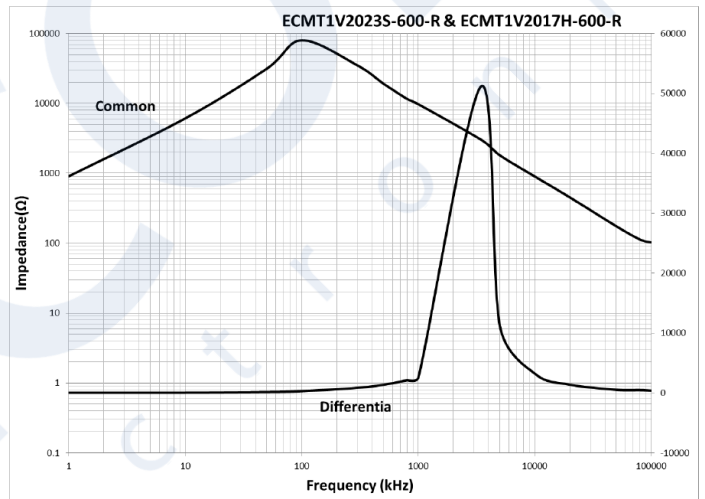
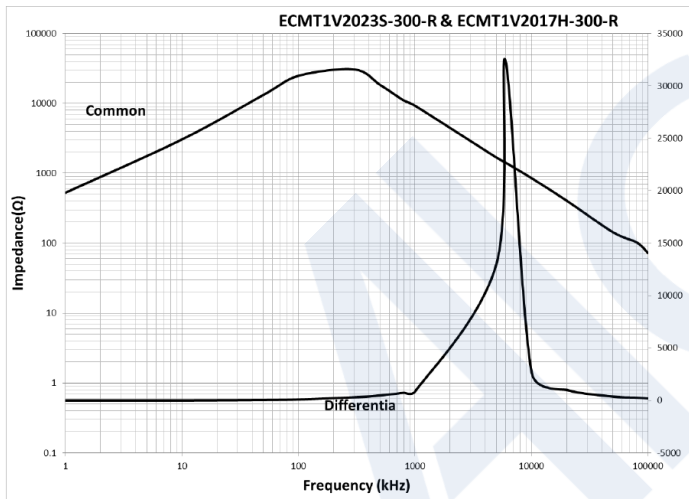
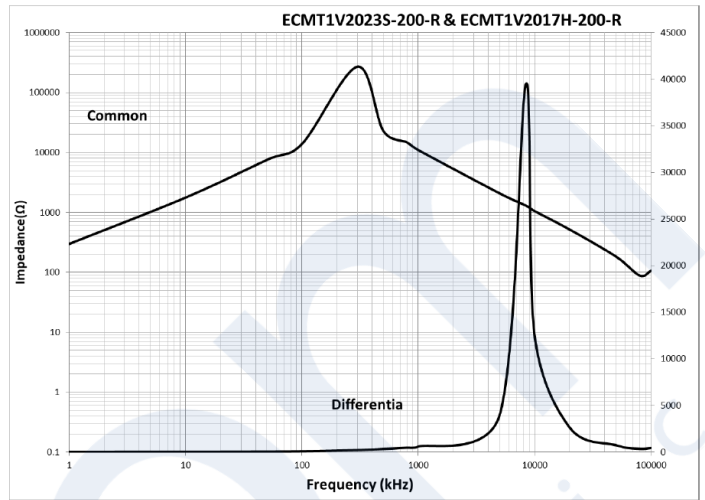
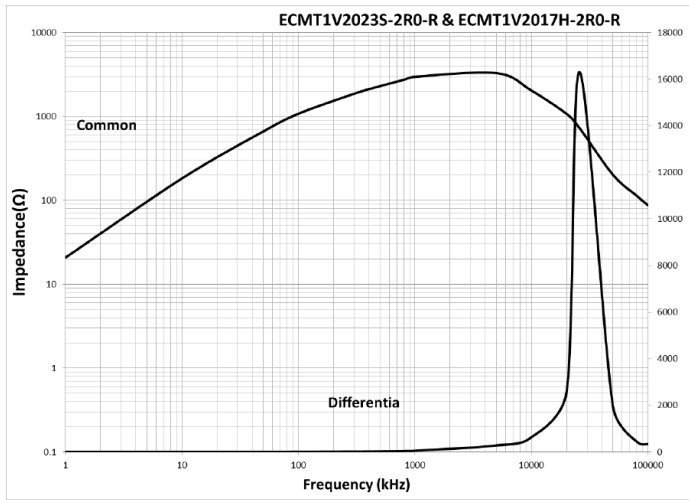

Measurement method

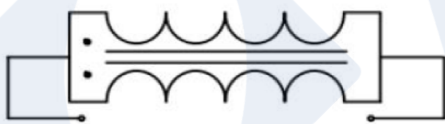

Common Mode

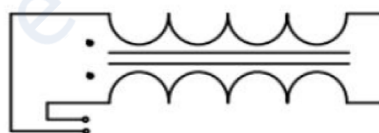

Differential Mode

Inductance vs frequency

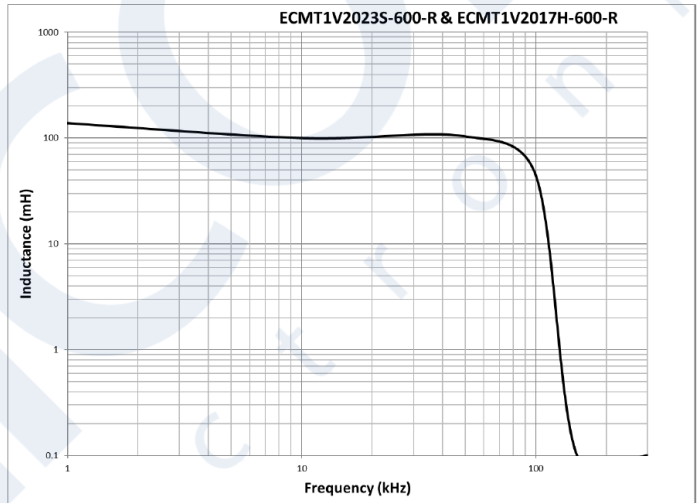
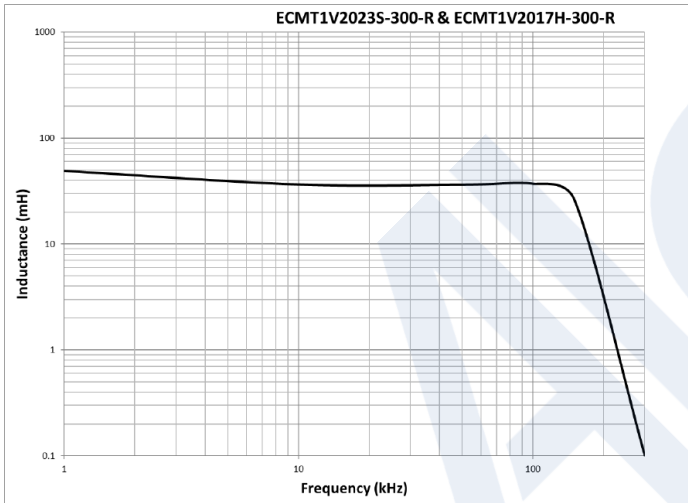
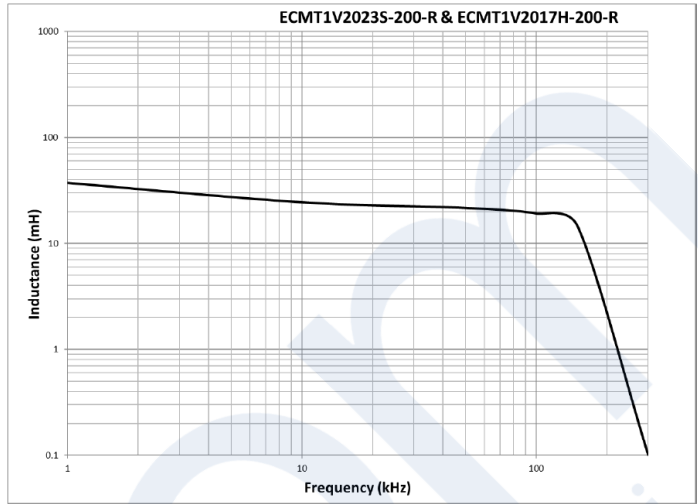
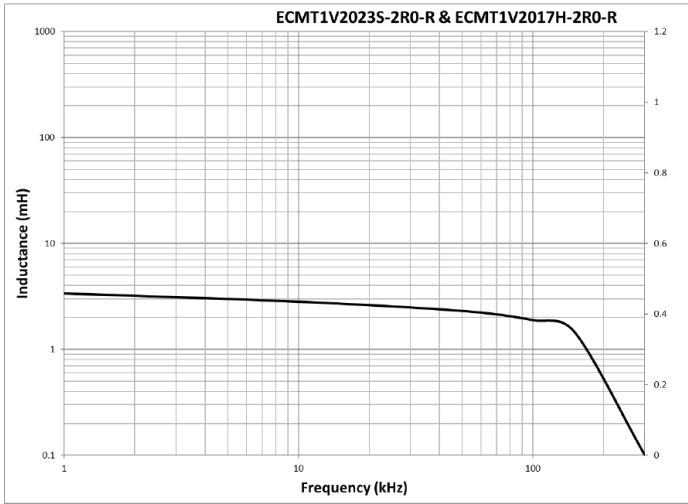

Wave solder profile

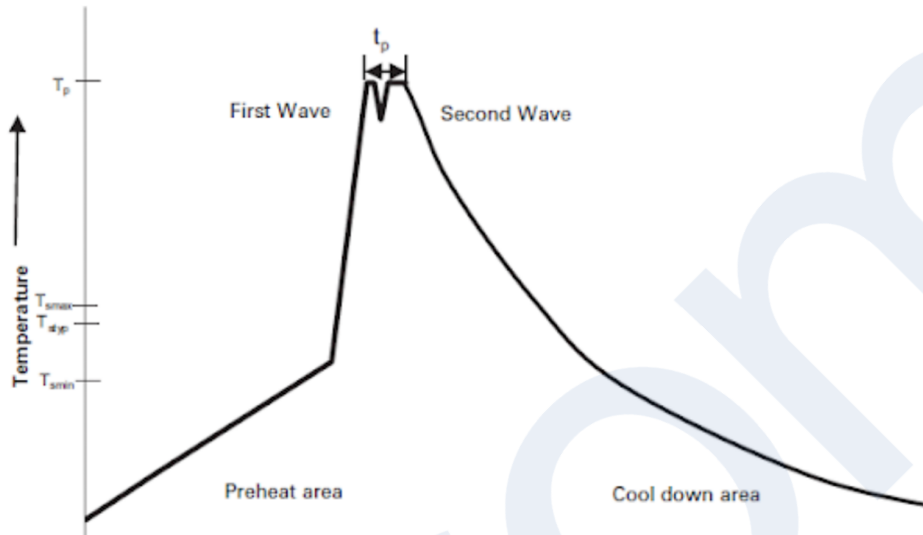

Reference EN 61760-1:2006

Profile feature	Standard SnPb solder	Lead (Pb) free solder
Preheat		
• Temperature min. (T_{smin})	100 °C	100 °C
• Temperature typ. (T_{styp})	120 °C	120 °C
• Temperature max. (T_{smax})	130 °C	130 °C
• Time (T_{smin} to T_{smax}) (t_s)	70 seconds	70 seconds
Δ preheat to max Temperature	150 °C max.	150 °C max.
Peak temperature (T_p)*	235 °C – 260 °C	250 °C – 260 °C
Time at peak temperature (t_p)	10 seconds max 5 seconds max each wave	10 seconds max 5 seconds max each wave
Ramp-down rate	~ 2 K/s min ~3,5 K/s typ ~5 K/s max	~ 2 K/s min ~3,5 K/s typ ~5 K/s max
Time 25 °C to 25 °C	4 minutes	4 minutes

Manual solder

+350 °C, 4-5 seconds. (by soldering iron), generally manual, hand soldering is not recommended.

Life Support Policy: Eaton does not authorize the use of any of its products for use in life support devices or systems without the express written approval of an officer of the Company. Life support systems are devices which support or sustain life, and whose failure to perform, when properly used in accordance with instructions for use provided in the labeling, can be reasonably expected to result in significant injury to the user.

Eaton reserves the right, without notice, to change design or construction of any products and to discontinue or limit distribution of any products. Eaton also reserves the right to change or update, without notice, any technical information contained in this bulletin.

Eaton
Electronics Division
1000 Eaton Boulevard
Cleveland, OH 44122
United States
www.eaton.com/electronics

© 2021 Eaton
All Rights Reserved
Printed in USA
Publication No. ELX1093 BU-ELX21103
September 2021

Eaton is a registered trademark.

All other trademarks are property of their respective owners.

Follow us on social media to get the latest product and support information.

