

ACE1V3225

Automotive grade common-mode chip inductor



Product features

- AEC-Q200 qualified
- 1210 (3225 metric) package
- Impedance range from 500 ohms to 15000 ohms
- Inductance range from 11 uH to 200 uH
- Moisture sensitivity level (MSL): 1

Applications

- Controller area network (CAN)
- Ethernet architectures
- Automotive signal line filter
- Advanced driver assistance systems (ADAS)
- Infotainment, safety cameras, sensors, xEV, Powertrain
- Engine control unit (ECU)
- Electric power steering system (EPS)
- Battery management systems (BMS)

Environmental data

- Operating temperature range: -40 °C to +125 °C (ambient plus self-temperature rise)
- Solder reflow temperature: J-STD-020 (latest revision) compliant



EATON

Powering Business Worldwide



Singel 3 | B-2550 Kontich | Belgium | Tel. +32 (0)3 458 30 33 | info@alcom.be | www.alcom.be

Rivium 1e straat 52 | 2909 LE Capelle aan den IJssel | The Netherlands | Tel. +31 (0)10 288 25 00 | info@alcom.nl | www.alcom.nl

Product specifications

Part number	Common-mode impedance Z (Ω) at 10 MHz	Common-mode inductance (μH) at 100 kHz	DCR (Ω) @ +25 ° maximum	Idc (mA) maximum	Rated voltage (Vdc) typical	Insulation resistance (MΩ) minimum
ACE1V3225-110-R	300 minimum 500 typical	11+50%/-30%	0.40	300	80	10
ACE1V3225-220-R	500 minimum 1000 typical	22+50%/-30%	0.50	250	80	10
ACE1V3225-510-R	1000 minimum 2600 typical	51+50%/-30%	0.70	200	80	10
ACE1V3225-101-R	2200 minimum 5100 typical	100+50%/-30%	1.50	150	80	10
ACE1V3225-201-R	NA	200+30%/-20%	4.80	70	80	10

1. Part Number Definition: ACE1V3225-xxn-R
 ACE1V3225 = Product code and size
 xx= inductance value in uH,
 n= multiplication factor: 10^n (i.e. 110 = 11 * 10^0 = 11 uH)
 -R suffix = RoHS compliant

Mechanical parameters, schematic, pad layout (mm)

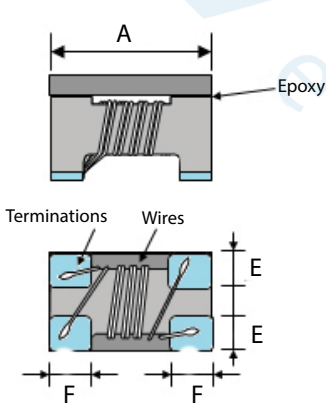

Recommended pad layout

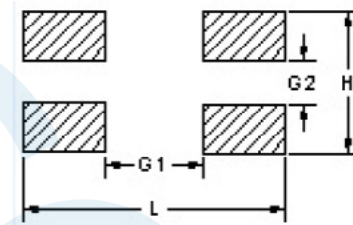

Equivalent circuit

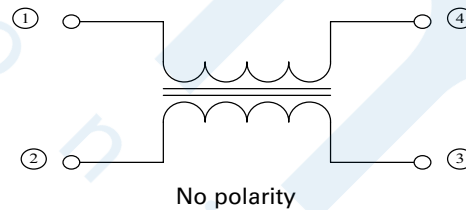

Part Number	A	B	C	D	E	F	L	H	G1	G2
ACE1V3225-xxn-R	3.2±0.2	2.5±0.2	2.5 max	0.2±0.1	0.9 typ	08 typ	3.7 typ	2.8 typ	2.4 typ	1.2 typ

All soldering surfaces to be coplanar within 0.1 millimeters
 Tolerances are ±0.1 millimeters unless stated otherwise
 Pad layout dimensions are reference only
 Traces or vias underneath the inductor is not recommended

Packaging information (mm)

Supplied in tape and reel packaging, 1000 parts per 7" diameter reel

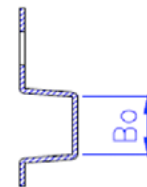
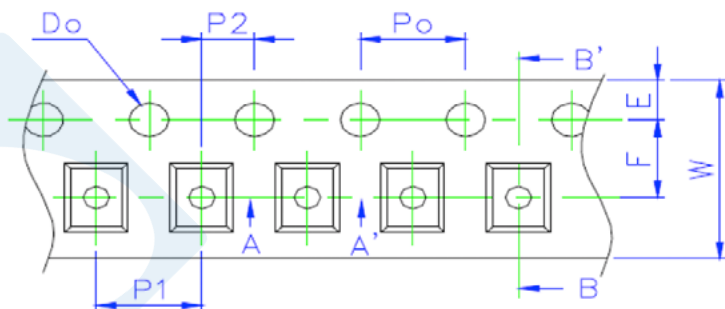

SEC: B-B'

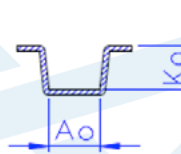

SEC: A-A'

Ao	2.80±0.10
Bo	3.60±0.10
Ko	2.20±0.10
W	8.00±0.20
E	1.75±0.10
F	3.50±0.05
Po	4.0±0.05
P1	4.0±0.10
Do	1.0±0.1

Performance curves

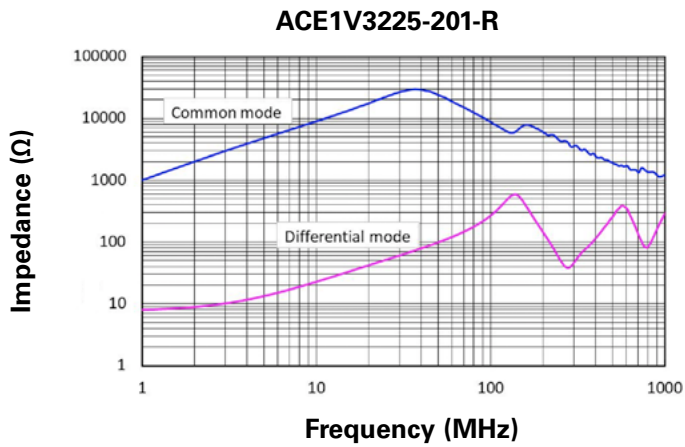
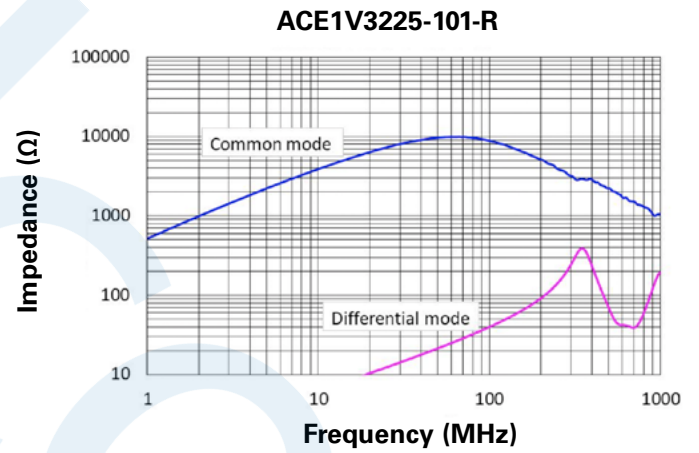
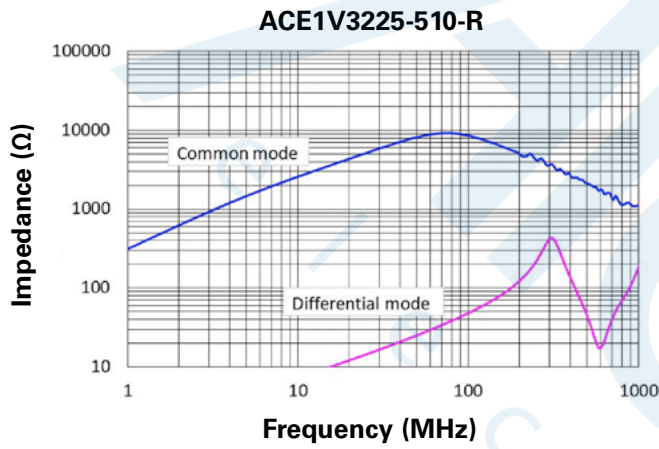
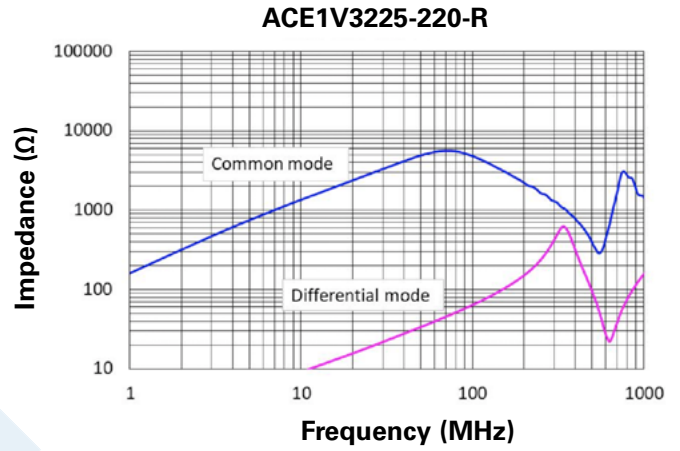
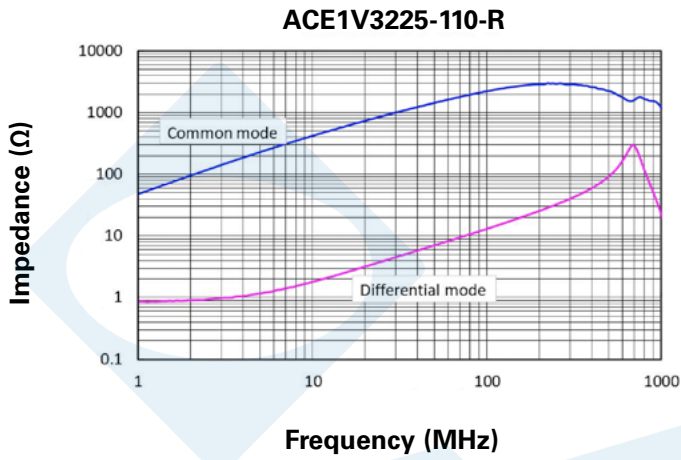

Common mode measurement method:

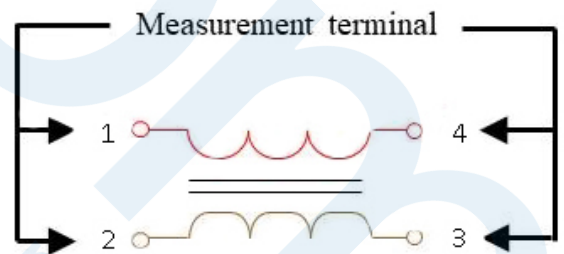

Differential mode measurement method:

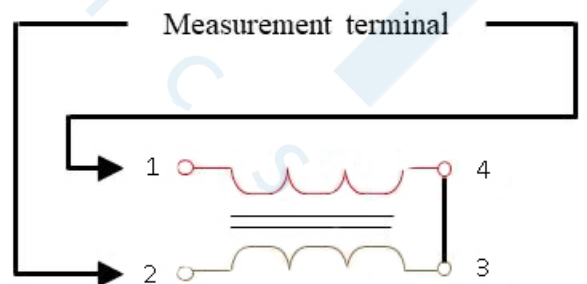

Solder reflow profile

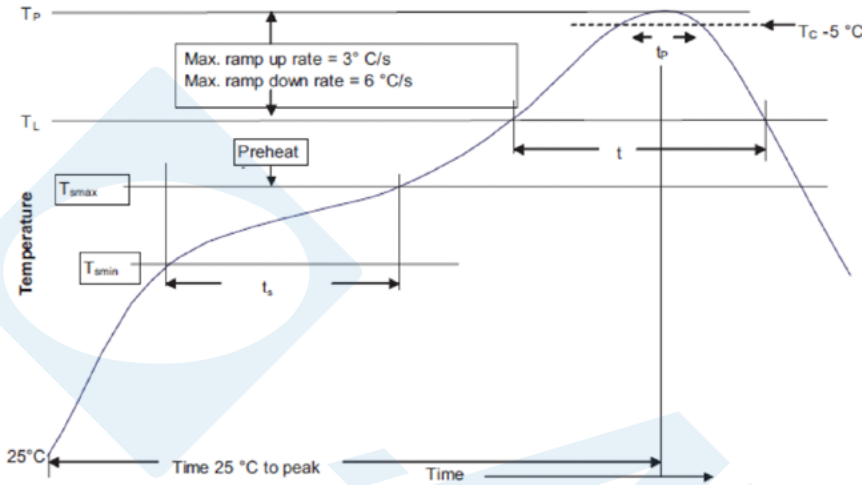

Table 1 - Standard SnPb solder (T_C)

Package Thickness	Volume mm ³ <350	Volume mm ³ ≥350
<2.5 mm)	235 °C	220 °C
≥2.5 mm	220 °C	220 °C

Table 2 - Lead (Pb) free solder (T_C)

Package thickness	Volume mm ³ <350	Volume mm ³ 350 - 2000	Volume mm ³ >2000
<1.6 mm	260 °C	260 °C	260 °C
1.6 – 2.5 mm	260 °C	250 °C	245 °C
>2.5 mm	250 °C	245 °C	245 °C

Reference J-STD-020

Profile feature	Standard SnPb solder	Lead (Pb) free solder
Preheat and soak		
• Temperature min. (T_{smin})	100 °C	150 °C
• Temperature max. (T_{smax})	150 °C	200 °C
• Time (T_{smin} to T_{smax}) (t_s)	60-120 seconds	60-120 seconds
Ramp up rate T_L to T_P	3 °C/ second max.	3 °C/ second max.
Liquidous temperature (T_L)	183 °C	217 °C
Time (t_L) maintained above T_L	60-150 seconds	60-150 seconds
Peak package body temperature (T_P)*	Table 1	Table 2
Time (t_p)* within 5 °C of the specified classification temperature (T_C)	20 seconds*	30 seconds*
Ramp-down rate (T_P to T_L)	6 °C/ second max.	6 °C/ second max.
Time 25 °C to peak temperature	6 minutes max.	8 minutes max.

* Tolerance for peak profile temperature (T_P) is defined as a supplier minimum and a user maximum.

Life Support Policy: Eaton does not authorize the use of any of its products for use in life support devices or systems without the express written approval of an officer of the Company. Life support systems are devices which support or sustain life, and whose failure to perform, when properly used in accordance with instructions for use provided in the labeling, can be reasonably expected to result in significant injury to the user.

Eaton reserves the right, without notice, to change design or construction of any products and to discontinue or limit distribution of any products. Eaton also reserves the right to change or update, without notice, any technical information contained in this bulletin.