

# 1245UMFF

## Universal modular fuse, fast acting, SMT



### Product features

- 12.5 x 4.8 x 4.8 mm surface mount package
- Complies with IEC60127-4 Universal modular fuse-links
- Fast acting
- 350 Vac/250 Vdc Voltage rating brick fuse
- Ceramic square body with end cap design
- Moisture sensitivity level (MSL): 1

### Applications

- Power supply
- White goods
- Lighting system
- Industrial equipment
- Lighting ballast
- AC/DC adaptor primary protection
- Medical Equipment
- Battery protection
- LCD monitor
- Office electronic equipment
- Industrial equipment

### Agency information

Universal modular fuse: UL file number: E526626



### Environmental compliance



### Ordering part number

\*The ordering code is the packaging code and part number replacing the "." with a "-" i.e. 1.25=1-25

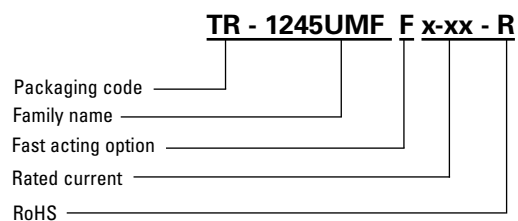

### Packaging prefix

TR- (1000 parts on a 13" diameter tape and reel)



Powering Business Worldwide

**Electrical characteristics**

Amp Rating	1.25 In minimum	2 In maximum	10 In
500 mA ~ 6.3 A	1 hour	120 seconds	1 - 10 milliseconds

**Product specifications**

Part number	Current rating (A)	Voltage rating (Vac)	Voltage rating (Vdc)	Interrupting rating @ rated voltage <sup>1</sup> (A) Vac	Interrupting rating @ rated voltage (A) Vdc	Typical cold resistance <sup>2</sup> (mΩ)	Maximum voltage drop (mV)	Part marking
1245UMFF500-R	0.5	350	250	200 A @ 250 Vac 100 A @ 350 Vac	100	300	600	BUSS F500 mA L 250 V
1245UMFF630-R	0.63	350	250	200 A @ 250 Vac 100 A @ 350 Vac	100	160	500	BUSS F630 mA L 250 V
1245UMFF800-R	0.8	350	250	200 A @ 250 Vac 100 A @ 350 Vac	100	110	400	BUSS F800 mA L 250 V
1245UMFF1-R	1	350	250	200 A @ 250 Vac 100 A @ 350 Vac	100	95	300	BUSS F1A L 250 V
1245UMFF1-25-R	1.25	350	250	200 A @ 250 Vac 100 A @ 350 Vac	100	70	300	BUSS F1.25 A L 250 V
1245UMFF1-6-R	1.6	350	250	200 A @ 250 Vac 100 A @ 350 Vac	100	58	300	BUSS F1.6 A L 250 V
1245UMFF2-R	2	350	250	200 A @ 250 Vac 100 A @ 350 Vac	100	40	300	BUSS F2A L 250 V
1245UMFF2-5-R	2.5	350	250	200 A @ 250 Vac 100 A @ 350 Vac	100	40	300	BUSS F2.5 A L 250 V
1245UMFF3-15-R	3.15	350	250	200 A @ 250 Vac 100 A @ 350 Vac	100	30	300	BUSS F3.15 A L 250 V
1245UMFF4-R	4	350	250	200 A @ 250 Vac 100 A @ 350 Vac	100	19	300	BUSS F4A L 250 V
1245UMFF5-R	5	350	250	200 A @ 250 Vac 100 A @ 350 Vac	100	16	300	BUSS F5A L 250 V
1245UMFF6-3-R	6.3	350	250	200 A @ 250 Vac 100 A @ 350 Vac	100	13	300	BUSS F6.3 A L 250 V

1. AC Interrupting rating (measured at designated voltage, >95% power factor and 30 ° closing angle)

2. Typical cold resistance is measured at <10% of rated current in ambient temperature of +25 °C

**Dimensions- mm**

Drawing not to scale

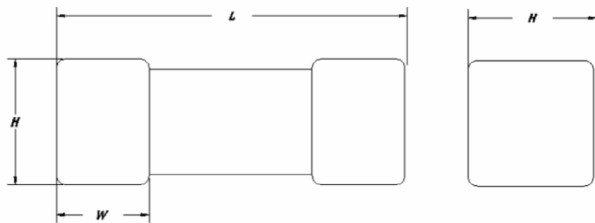

**Recommended pad layout**

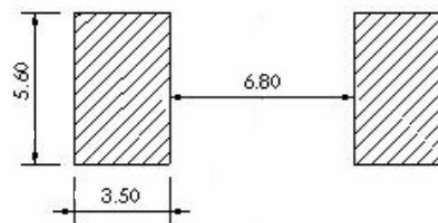

Rating	L	W	H
0.5 A to 6.3 A	12 maximum	2.7 ± 0.30	4.5 ± 0.30

**General specifications**

Operating temperature: -40 °C to +125 °C with proper derating factor applied

Thermal shock: MIL-STD-202 Method 107, -40 °C/+125 °C, 1000 cycles, Maximum transfer time 20 seconds, Dwell time 15 minutes. Air-Air

Humidity bias: MIL-STD-202 Method 103, 1000 hours +85 °C/85%RH.

Solderability: J-STD-002, Method B1 Steam aging 1 hour, Solder temperature +255 ± 5 °C, solder immersion time 5 s

Mechanical shock: MIL-STD-202 Method 213, Figure 1 of Method 213. Condition C 100 g 6 ms

High temperature operating life: MIL-STD-202 Method 108, Condition D steady state TA=+70 °C at 60% rated current.

Vibration: MIL-STD-202F Method 201, 2 hours each of 3 orientations. Test from 10-55 Hz in 1 Min.

Soldering heat resistance: MIL-STD-202 Method 210, Solder temperature +260 ±5 °C, solder immersion time 10 ±5 s

**Packaging information - mm**

1000 parts per 13" diameter reel (EIA-481 compliant)

Drawing not to scale

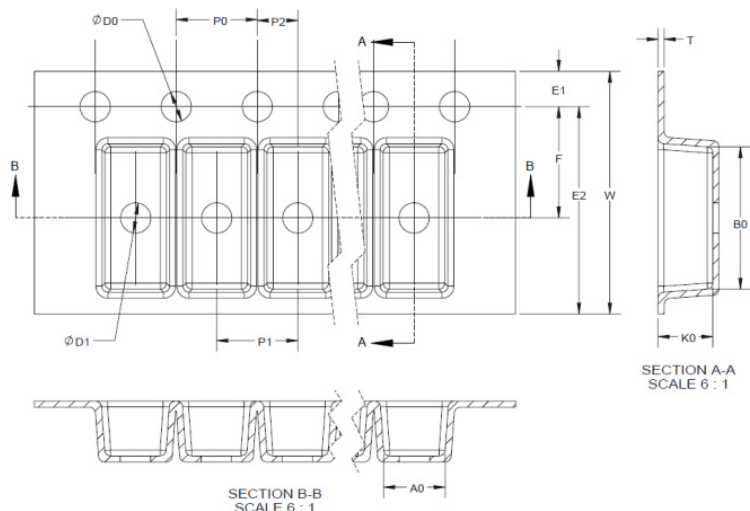

Dimension	millimeter
W	24.00
F	11.50
E1	1.75
P0	4.00
P1	8.00
P2	2.00
$\phi D0$	1.50
A0	4.90
B0	12.70
K0	4.50
T	0.40

**Reel dimension- mm**

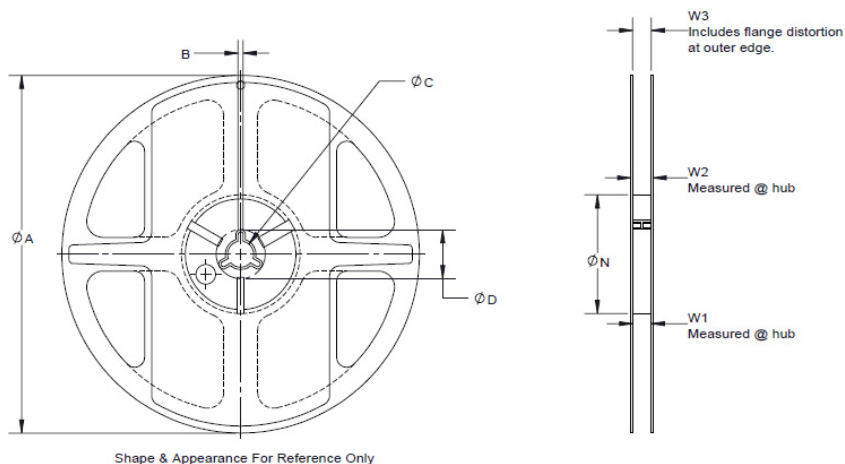

Dimension	millimeter
A	330 ± 1.0
B	2.1 ± 0.5
C	13.5 ± 0.5
W1	25 ± 0.3
W2	30.4 Max

### Temperature derating curve

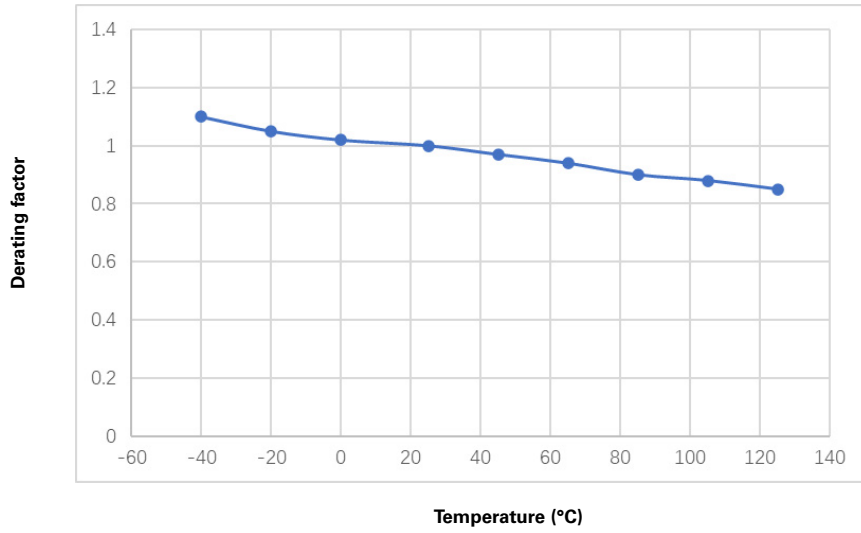

### Current vs. time curve

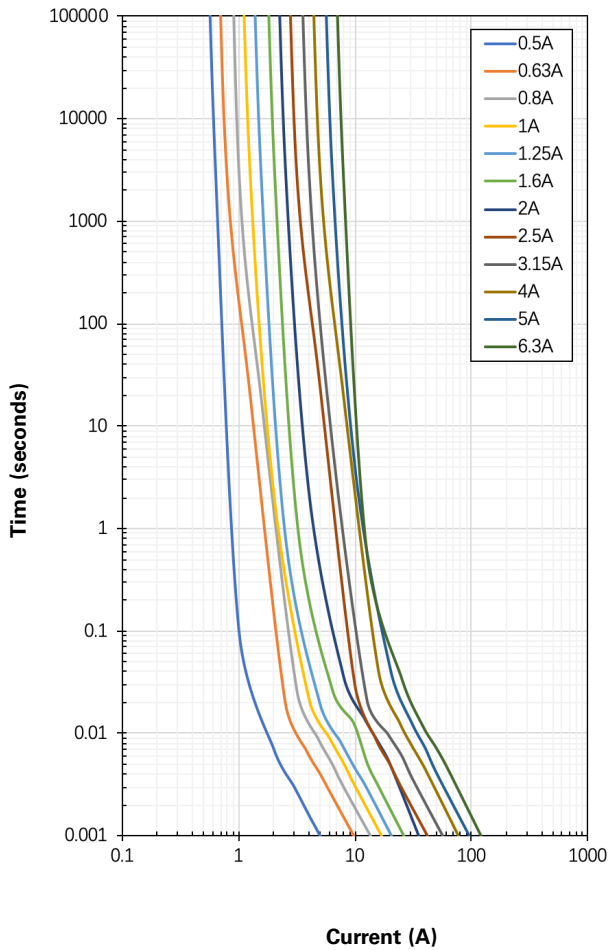

I<sup>2</sup>T vs. time curve

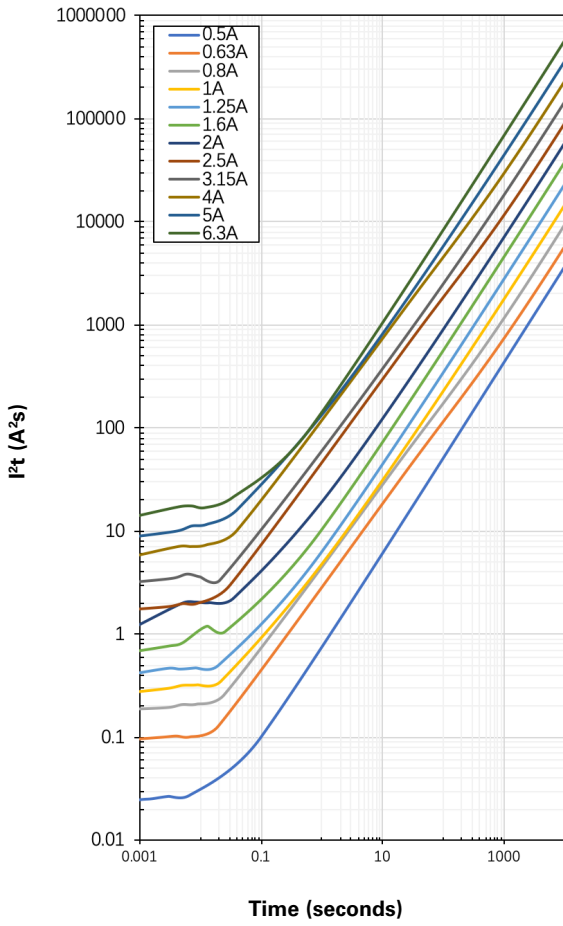

I<sup>2</sup>T vs. current curve

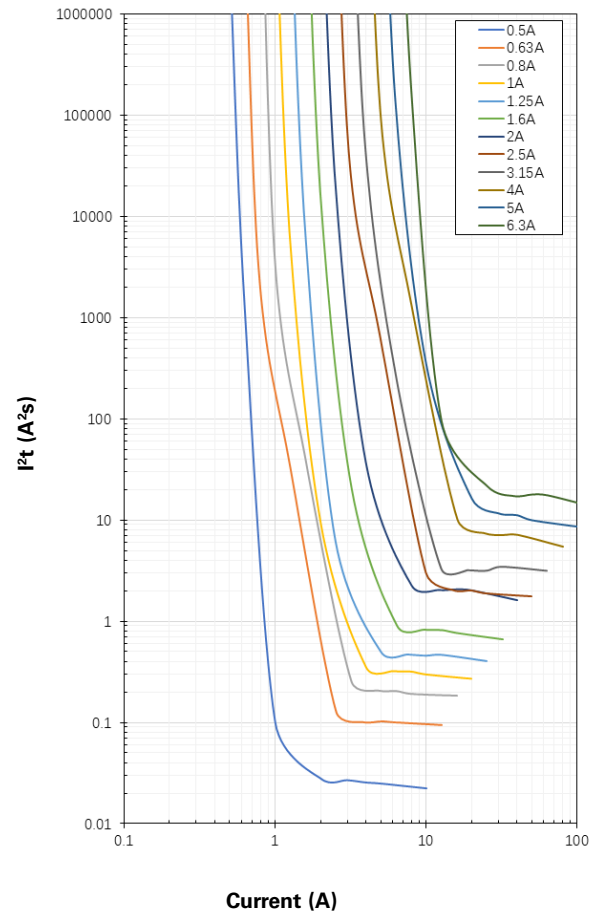

### Wave solder profile

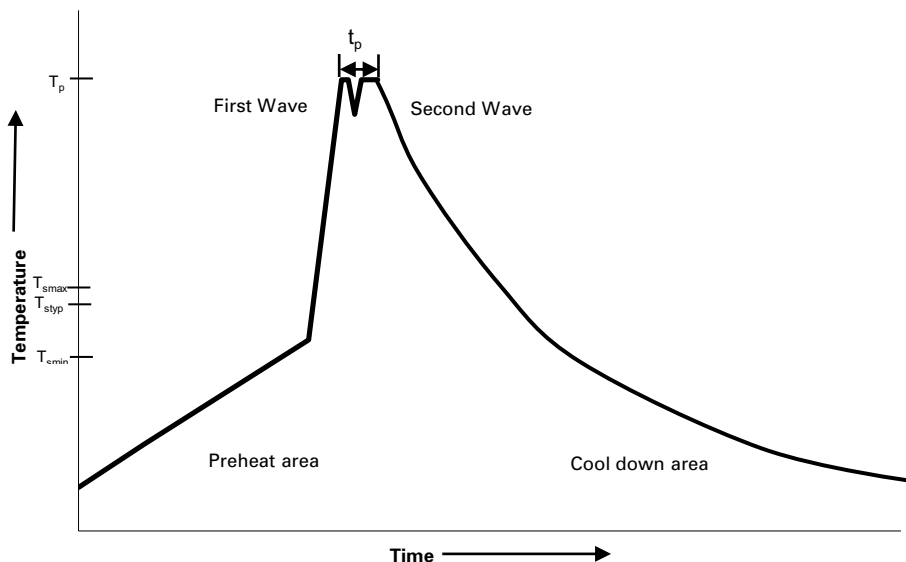

### Reference EN 61760-1:2006

Profile feature	Standard SnPb solder	Lead (Pb) free solder
Preheat	• Temperature min. ( $T_{smin}$ )	100 °C
	• Temperature typ. ( $T_{styp}$ )	120 °C
	• Temperature max. ( $T_{smax}$ )	130 °C
	• Time ( $T_{smin}$ to $T_{smax}$ ) ( $t_s$ )	70 seconds
$\Delta$ preheat to max Temperature	150 °C max.	150 °C max.
Peak temperature ( $T_p$ )*	235 °C – 260 °C	250 °C – 260 °C
Time at peak temperature ( $t_p$ )	10 seconds max 5 seconds max each wave	10 seconds max 5 seconds max each wave
Ramp-down rate	~ 2 K/s min ~ 3.5 K/s typ ~ 5 K/s max	~ 2 K/s min ~ 3.5 K/s typ ~ 5 K/s max
Time 25 °C to 25 °C	4 minutes	4 minutes

### Manual solder

+350 °C (4-5 seconds by soldering iron), generally manual/hand soldering is not recommended.

Solder reflow profile

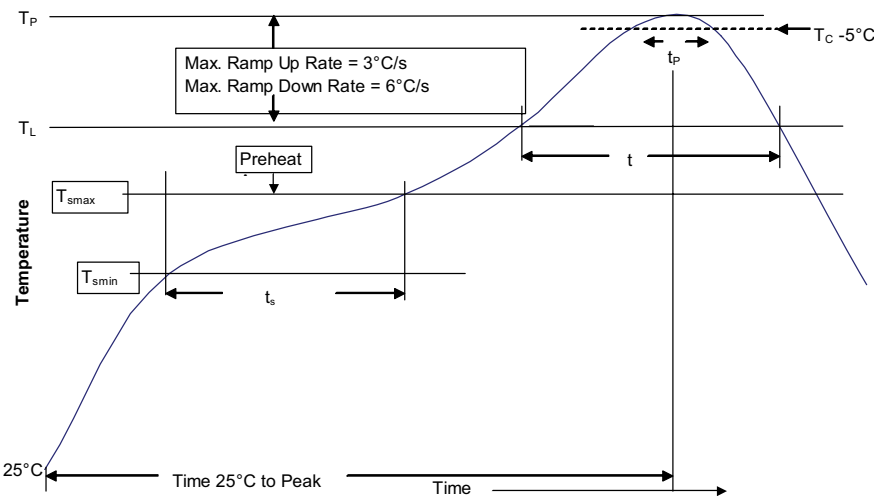

Table 1 - Standard SnPb solder (T<sub>C</sub>)

Package thickness	Volume mm <sup>3</sup> <350	Volume mm <sup>3</sup> ≥350
<2.5 mm	235 °C	220 °C
≥2.5 mm	220 °C	220 °C

Table 2 - Lead (Pb) free solder (T<sub>C</sub>)

Package thickness	Volume mm <sup>3</sup> <350	Volume mm <sup>3</sup> 350 - 2000	Volume mm <sup>3</sup> >2000
<1.6 mm	260 °C	260 °C	260 °C
1.6 – 2.5 mm	260 °C	250 °C	245 °C
>2.5 mm	250 °C	245 °C	245 °C

Reference J-STD-020

Profile feature	Standard SnPb solder	Lead (Pb) free solder
Preheat and soak		
• Temperature min. (T <sub>smin</sub> )	100 °C	150 °C
• Temperature max. (T <sub>smax</sub> )	150 °C	200 °C
• Time (T <sub>smin</sub> to T <sub>smax</sub> ) (t <sub>s</sub> )	60-120 seconds	60-120 seconds
Ramp up rate T <sub>L</sub> to T <sub>p</sub>	3 °C/ second max.	3 °C/ second max.
Liquidous temperature (T <sub>L</sub> )	183 °C	217 °C
Time (t <sub>L</sub> ) maintained above T <sub>L</sub>	60-150 seconds	60-150 seconds
Peak package body temperature (T <sub>p</sub> )*	Table 1	Table 2
Time (t <sub>p</sub> )* within 5 °C of the specified classification temperature (T <sub>C</sub> )	20 seconds*	30 seconds*
Ramp-down rate (T <sub>p</sub> to T <sub>L</sub> )	6 °C/ second max.	6 °C/ second max.
Time 25 °C to peak temperature	6 minutes max.	8 minutes max.

\* Tolerance for peak profile temperature (T<sub>p</sub>) is defined as a supplier minimum and a user maximum.

Life Support Policy: Eaton does not authorize the use of any of its products for use in life support devices or systems without the express written approval of an officer of the Company. Life support systems are devices which support or sustain life, and whose failure to perform, when properly used in accordance with instructions for use provided in the labeling, can be reasonably expected to result in significant injury to the user.

Eaton reserves the right, without notice, to change design or construction of any products and to discontinue or limit distribution of any products. Eaton also reserves the right to change or update, without notice, any technical information contained in this bulletin.

**Eaton**  
**Electronics Division**  
 1000 Eaton Boulevard  
 Cleveland, OH 44122  
 United States  
 Eaton.com/electronics

© 2022 Eaton  
 All Rights Reserved  
 Printed in USA  
 Publication No. ELX1120 BU-ELX21128  
 March 2022

Eaton is a registered trademark.

All other trademarks are property of their respective owners.

Follow us on social media to get the latest product and support information.

