

External / In-building Knuckle Swivel, WiFi 6E Stick Antenna

W5098



 **Pulse**
a YAGEO company

- Ⓢ WiFi-6E, Zigbee, BLE/BT, DSRC V2x Communication
- Ⓢ Rugged Outdoor Systems
- Ⓢ Marine, Mining, Utility, Oil/Gas Environments
- Ⓢ Industrial Applications
- Ⓢ Metering, Security, IoT Applications
- Ⓢ Outdoor Networking, Data Transmission, Access Points

Electrical Specifications @ 25C - Operating Temperature -40C to 85C, Storage Temperature -40C to 85C

Frequency Bands: 2.4-2.5GHz, 5.15-7.125GHz

Antenna Type	Nominal Impedance	Radiation Pattern	Polarization	VSWR
Stick Antenna	50Ω	Omni	Vertical	2.0 Max
Frequency	2.4-2.5GHz		5.15-7.125GHz	
Average Efficiency	75%		71%	
Peak Gain	3.5dBi		3.8dBi	

Mechanical Specifications

Part Number	Length	Color	Weight	Connector Type	Plastic Radome	Flammability	Ingress Protection
W5098	5.92 Inches	Black	17.3grms	RP-SMA	TPEE	UL94-V0	IP67

Mechanical

W5098

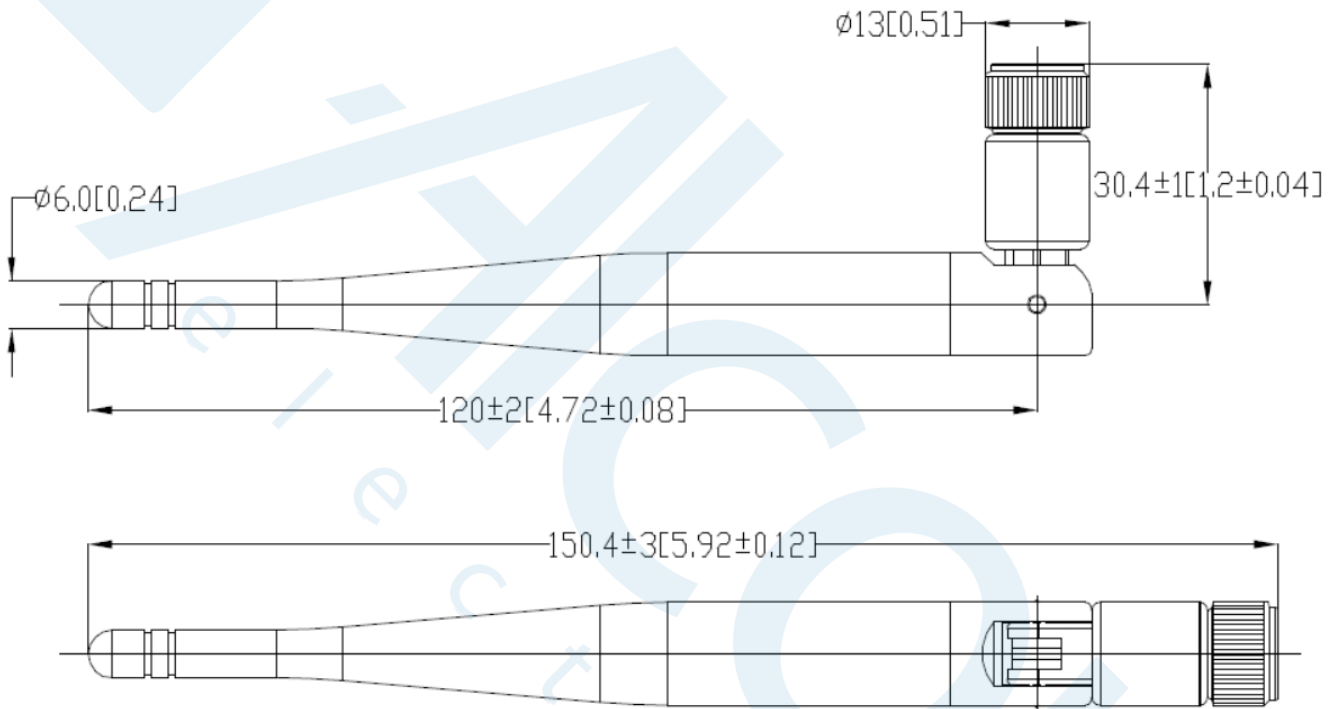

Packaging

W5098

10PCS/Bullet PE bag
500PCS/Carton Box

Charts

W5029x

VSWR measured in free space

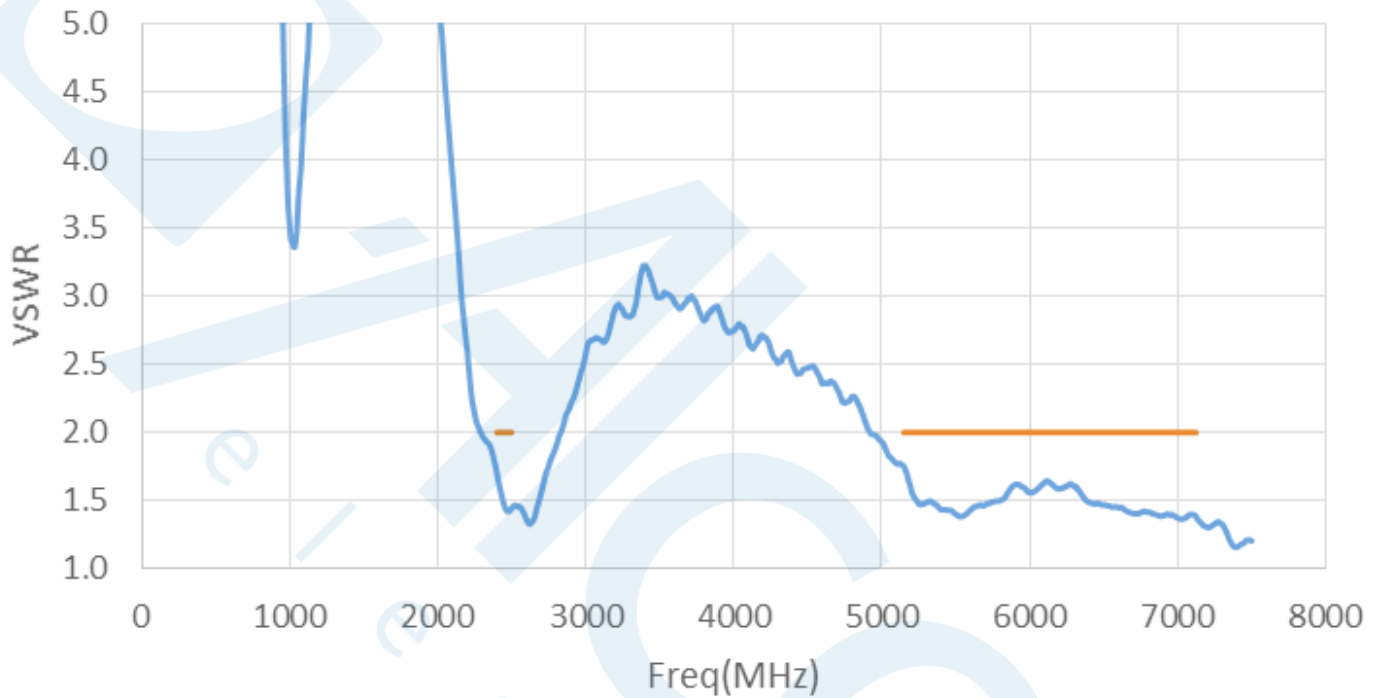

Chamber set up

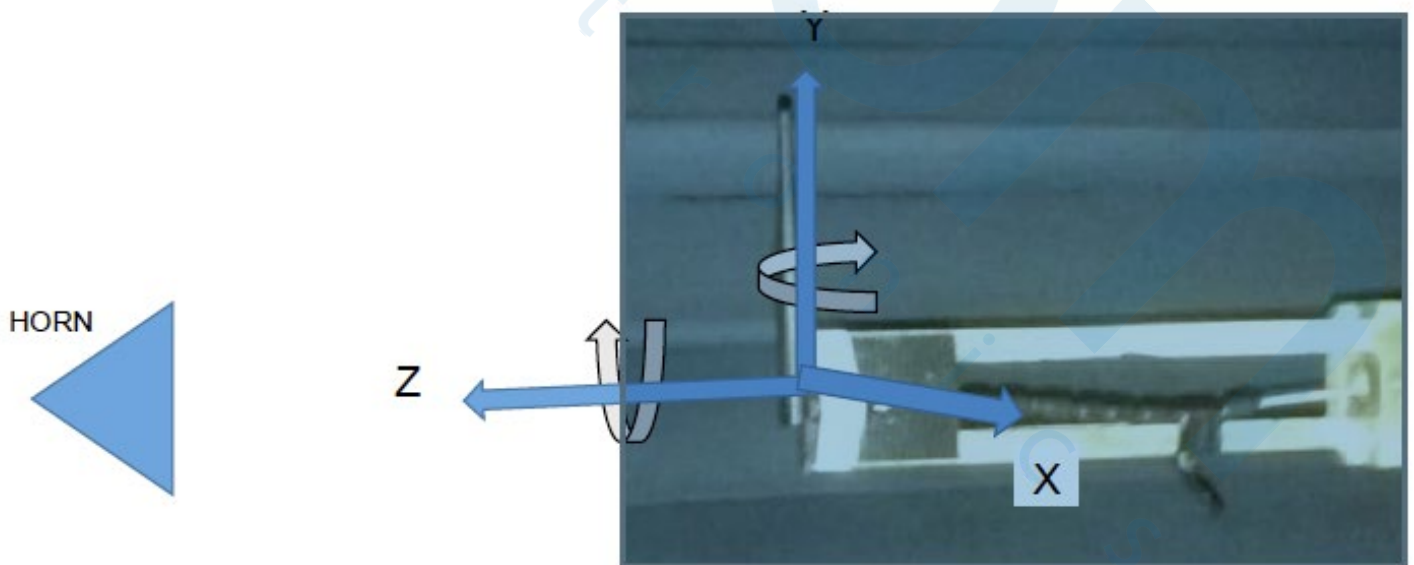

Efficiency measured in free space right angle

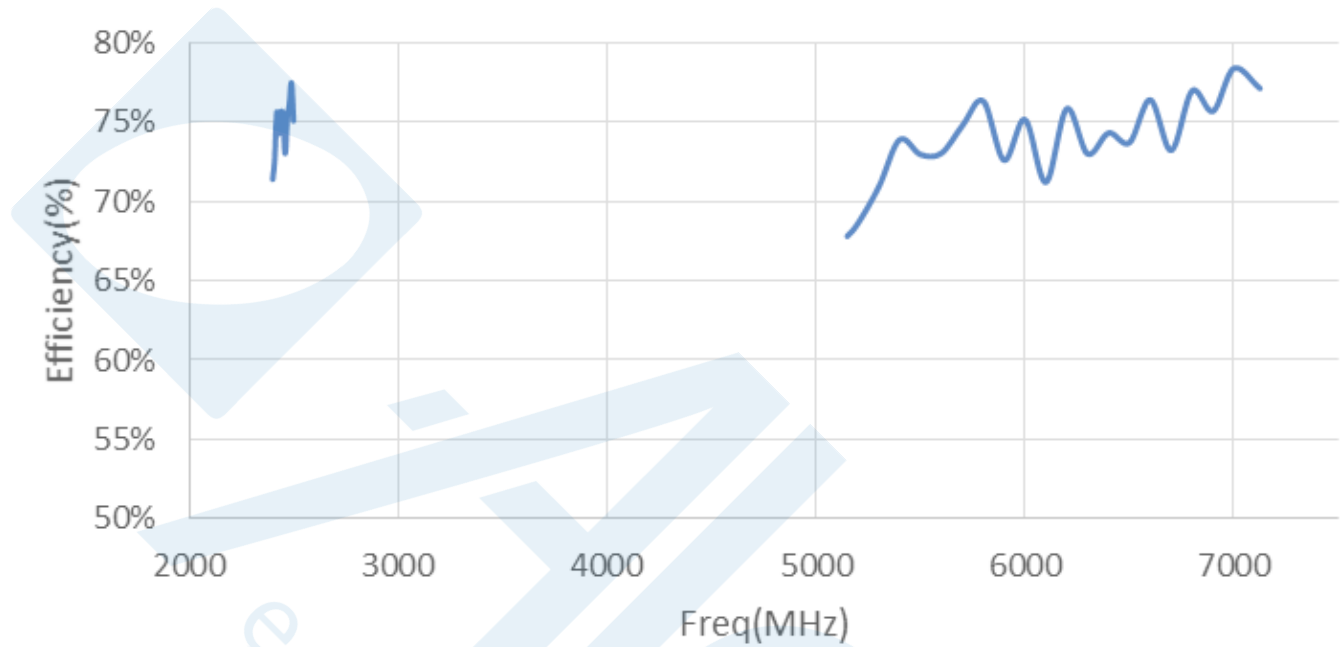

Peak Gain measured in free space right angle

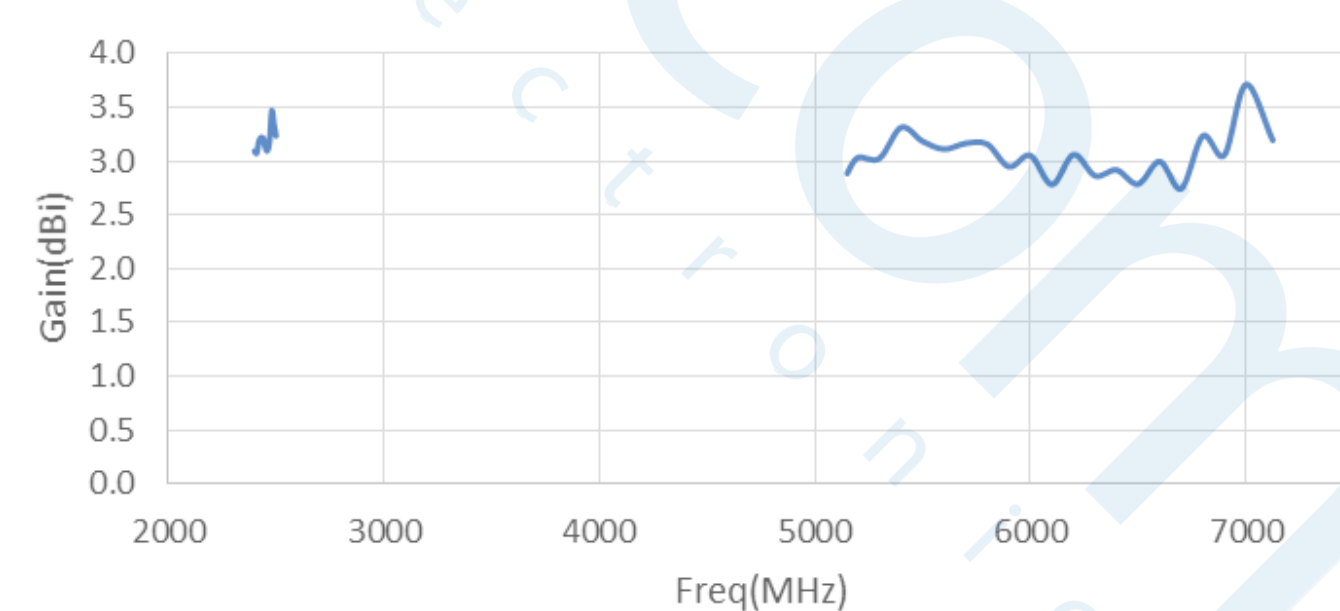

Horizontal Plane

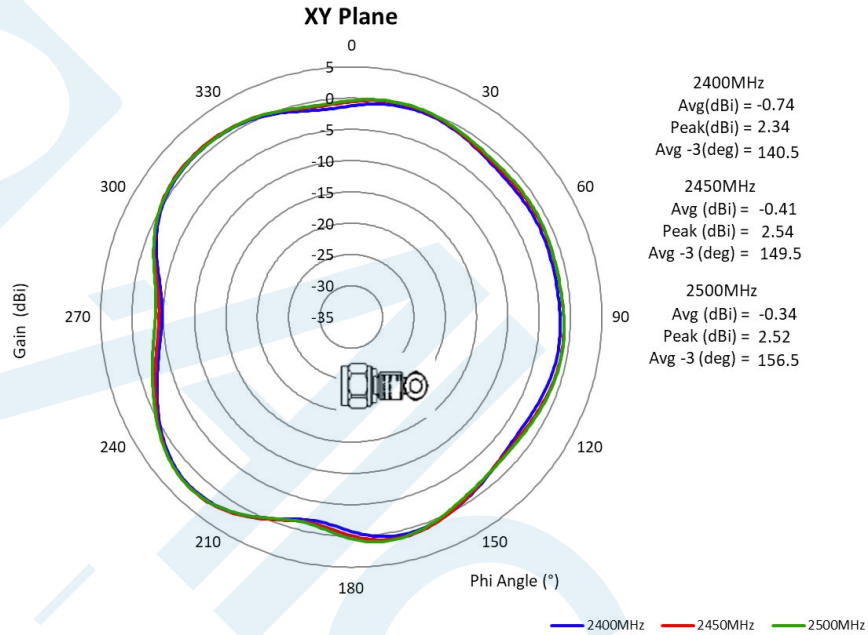

Vertical Plane

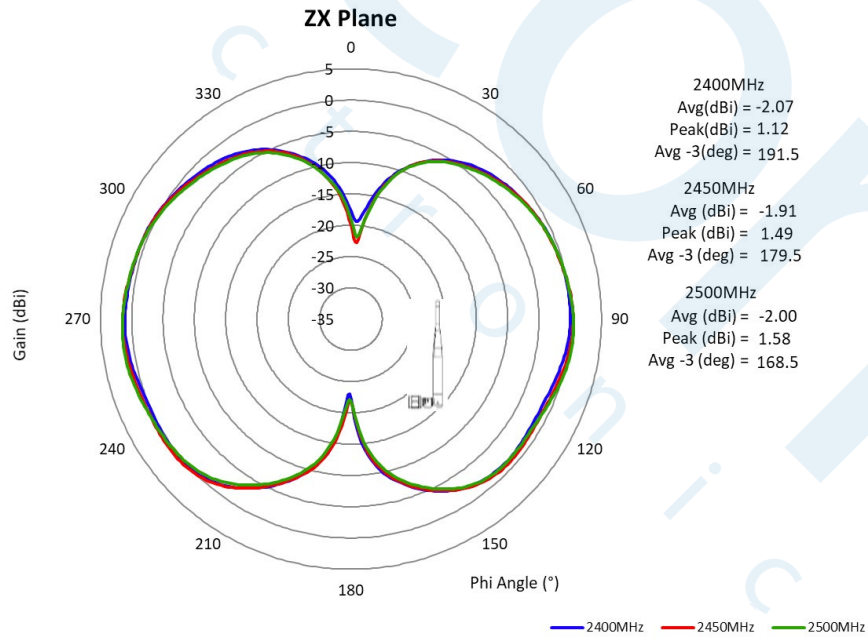

External / In-building Knuckle Swivel, WiFi 6E Stick Antenna W5098

Horizontal Plane

XY Plane

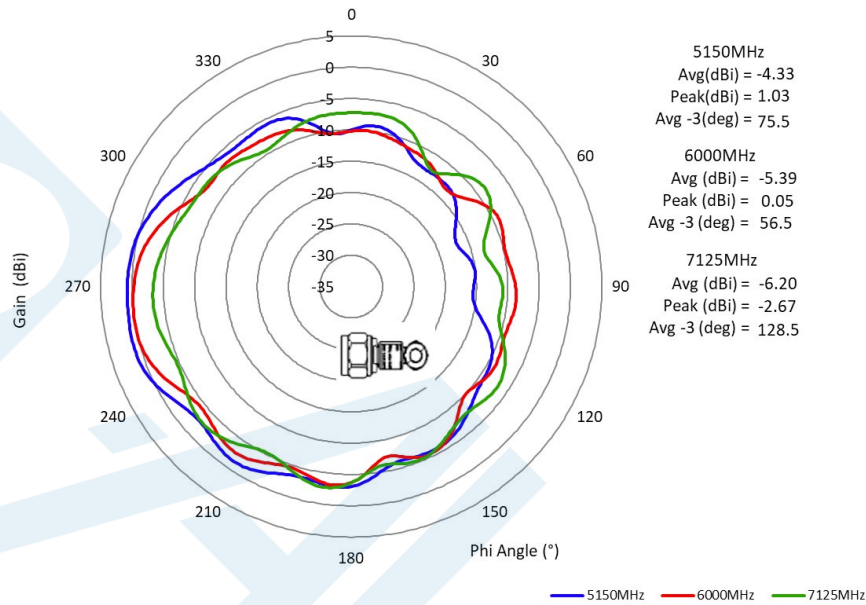

Vertical Plane

ZX Plane

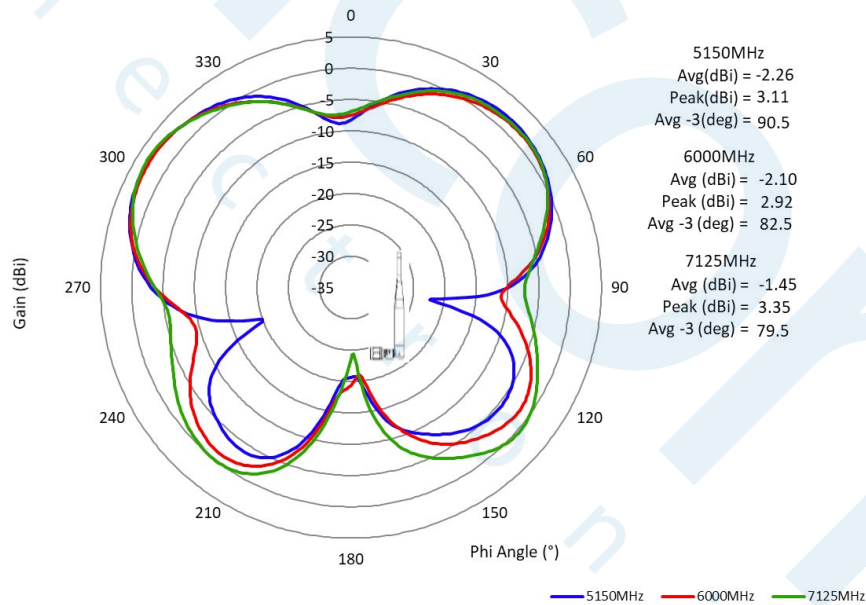

Performance warranty of products offered on this data sheet is limited to the parameters specified. Data is subject to change without notice. Other brand and product names mentioned herein may be trademarks or registered trademarks of their respective owners. © Copyright, 2020. Pulse Electronics, Inc. All rights reserved.

