







Outdoor Low profile direct mount Antenna

SKF490DM – 470-512 MHz



Features & Applications:

-  Vehicle roof mount, directly on metal plane
-  470-512MHz
-  Cable length and connector type per request
-  Available in Black (P/N SKF490DM) or White (P/N SKF490DMW)
-  Heavy and light vehicles
-  IoT, navigation, tracking

Electrical specifications @ 25° C

Frequency Band – 470-512 MHz

Antenna type ¹	Nominal Impedance	Polarization	Radiation pattern	Power withstanding	DC Ground
Dipole	50Ω	Vertical	Omni	100W	Yes

Frequency (MHz)	470-512
VSWR W/17FT (5.2M) Cable	2.2:1
Peak Gain (dBi)	2.2
Efficiency (%)	85
HPBW Vertical Plane (°)	72

Mechanical Specifications

SKF490DM				
Size W/H/L	Color	Weight	Cable / Connector Type	Fixing System ²
52.5 (2.07") x 63.6 (2.50") x 178.3 (7.02") mm	Black	375grms (0.83lbs)	RG-58 / SMA-Male	Direct Mount
Housing Material	Operating Temperature	Storage Temperature	Ingress Protection	RoHS-6 Compliant
UV Protected Plastic	-40°C to +85°C	-40°C to +85°C	IP67	Yes

Notes:

1. Measured on Ø24" (609.6mm) ground plane.
2. Requires Ø.875" (22.3mm) hole.

Test Setup / Charts

SKF490DM



antenna sample measured on $\varnothing 24"$ (609.6mm) ground plane

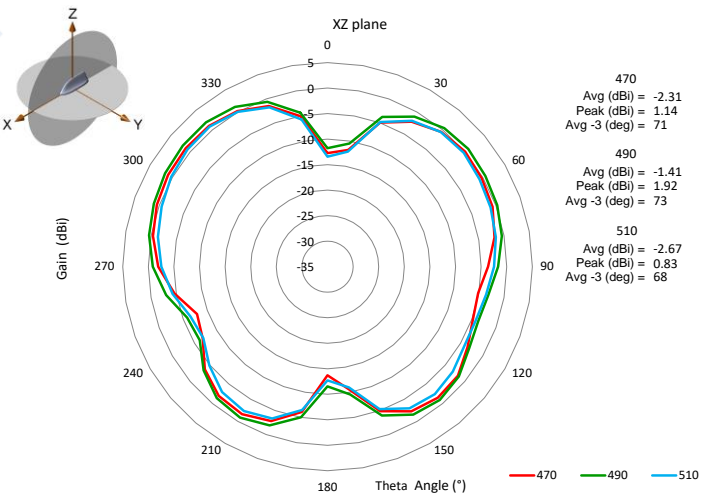
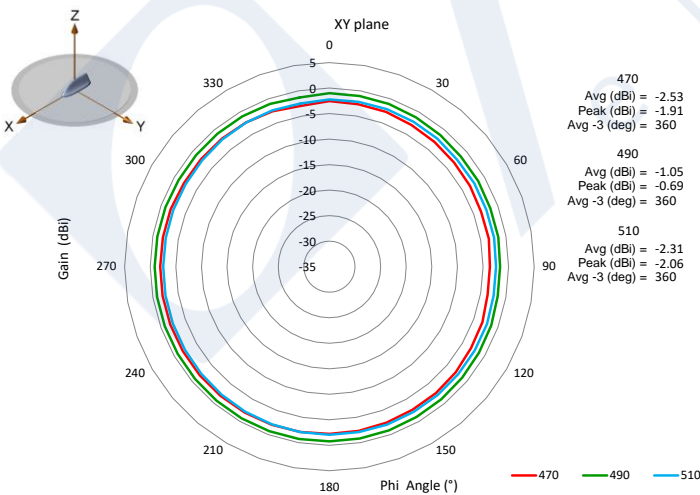
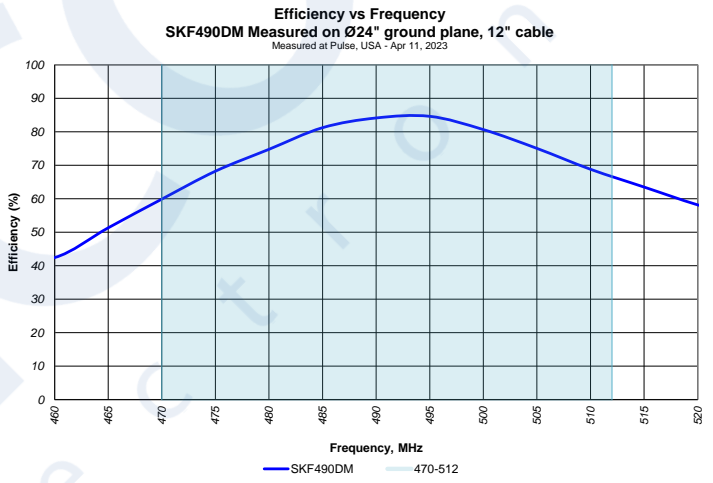
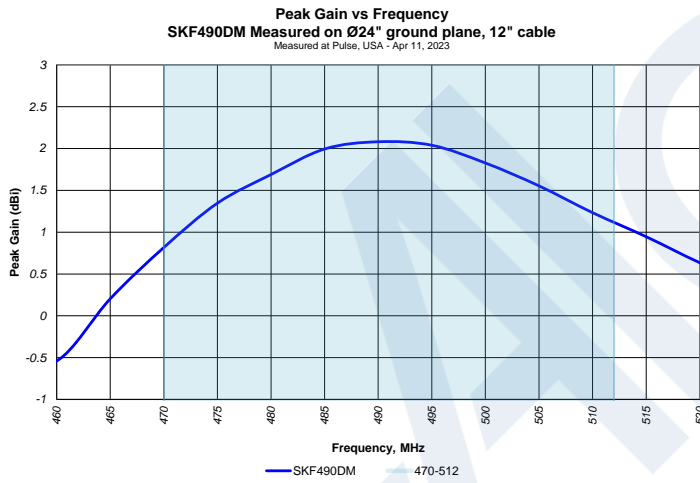
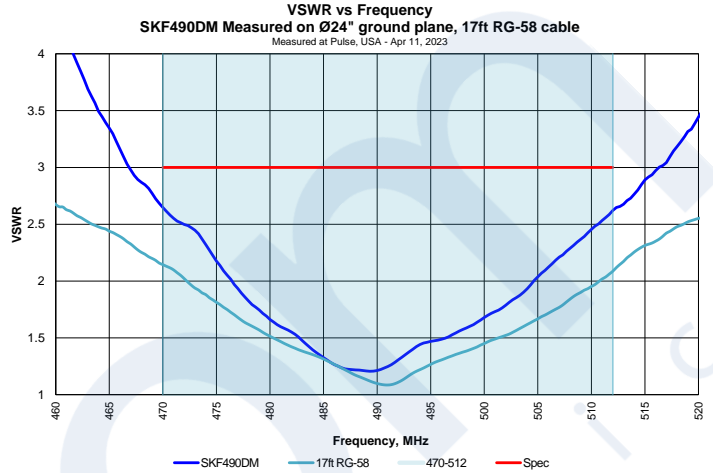

Mechanical Drawing

SKF490DM

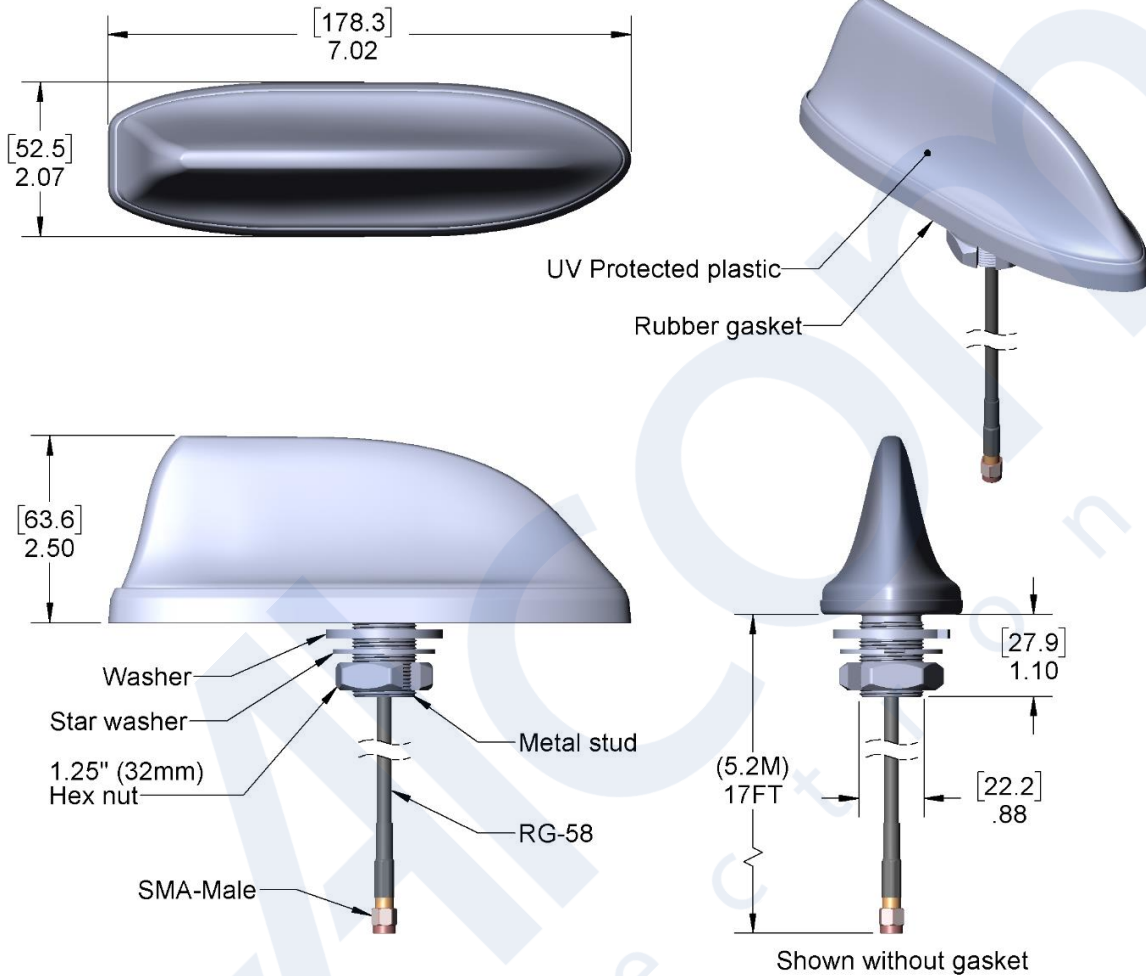

Dimensions: Inches (mm)
 Unless otherwise specified, all tolerances are ±.010 (0.25mm)

SKF490DM

Packaging

Packaging info:

- 1 antenna packed in a plastic bag.
- 1 label on each plastic bag with part number, description, date code.

Notes:

- Please contact sales for availability, lead time, and/or any special requests. Samples available upon request.

For More Information:

Americas - antennas.us@pulseelectronics.com | Europe – antennas.eu@pulseelectronics.com | Asia – antennas.as@pulseelectronics.com | Questions? +1-800-ANTENNA
 Performance warranty of products offered on this data sheet is limited to the parameters specified. Data is subject to change without notice. Other brand and product names mentioned herein may be trademarks or registered trademarks of their respective owners. © Copyright , 2020. Pulse Electronics, Inc. All rights reserved.
 Company address: Pulse Electronics, a YAGEO Company, 15255 Innovation Drive, Suite #100, San Diego, CA 92128