



# Active and Passive LED Heatsinks



## Table Of Contents

Pg 3	Introduction
Pg 4	CPL Series
Pg 7	CPL SQ Series
Pg 8	CHP Series
Pg 10	CSL 750 Series
Pg 13	CSL 780 Series
Pg 16	CSL7160 Series

Electronics

# Introduction

Cooliance is a leading provider of thermal management solutions offering its customers a wide range of products and services focused on the LED lighting and Electronic markets. The LED product line boasts a comprehensive offering of standard LED heatsinks ranging from 5W to 500W. The Electronic line consists of cold-forged, extruded and machined heatsinks some of which incorporate heat pipes or vapor chambers to spread the heat.

Cooliance's expertise in Thermal Management dates back to 1995. In 2004, the company developed a proprietary mechanical attach cooling solution for BGA chips called the Smart-CLIP™. This product line offers easy application, easy removal, and a highly reliable mechanical attach mechanism. Smart-CLIP™ quickly became the preferred solution for industry-leading providers of networking and communication products due to its flexibility, thermal performance, and high reliability.

Cooliance was one of the first thermal management company to develop products specifically designed for LED applications. In 2009 the company leveraged its precision cold forged pin fin manufacturing capability to create a broad range of standard LED heatsinks. The pin fin design offers significant advantages for cooling LED applications including:

- The pins provide a high degree of surface area
- The cold forging process produces a single piece of metal; a high-density heat sink that provides outstanding thermal conductivity
- The pin fin design will work effectively in many orientations
- The forging technology provides the capability to incorporate custom features into the tool
- The precision machined 10mm thick base offers high thermal conductivity and provides a flat, uninterrupted surface for hole patterns to support LED attachment, optics, and mounting brackets

Cooliance continues to expand its product line. In 2011, the Coolstrate® line of active LED heatsinks was launched offering 50,000 plus hours of quiet and reliable cooling performance. Cooliance recently launched a line of high power passive LED heatsinks manufactured with our bonded fin technology. These products provide a light-weight, highly effective cooling solutions for 150W, 200W & 250W applications. All Cooliance LED heatsinks are tested and matched to industry leading LED COB products and come with the specific hole patterns to support mounting of the COB.

In 2011, Cooliance launched Cooliance GmbH to provide sales, service and local inventory to support customers in Europe, the Middle East, and Africa. Cooliance manufactures products in Taiwan and China and in 2016 the company established a dedicated manufacturing facility in China.

Cooliance has earned a reputation for strong engineering, developing solutions to complex thermal management challenges, providing high-quality solutions at a competitive price and meeting its delivery commitments.



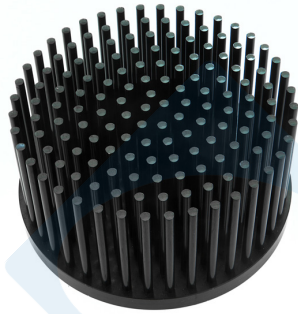

## Features

- Solid one-piece forged aluminum construction for maximum thermal conductivity.
- Pin fin design maximizes surface area and provides omnidirectional cooling to eliminate concerns about the orientation of the heat sink (unlike a linear extrusion).
- Precision-machined flat base ensures consistent contact between the heat sink, interface and LED substrate to maximize heat transfer.
- The standard 10mm base thickness allows for full recommended depth for mounting holes.
- Blank mounting surface. (If you require a hole mounting pattern for a specific LED, please refer to our website).

Model	Diameter (mm)	Height (mm)	Base Thickness (mm)	Weight (g)	Thermal Resistance (°C/W)	Power Dissipation (W)*	
						Ambient 25°C	Ambient 35°C
CPL4050-101	40	50	10	50	3.70	20	17
CPL4070-101	40	70	10	60	3.05	25	20
CPL5050-101	51	50	10	86	2.90	26	22
CPL5070-101	51	70	10	104	2.45	31	26
CPL7050-101	70	50	10	154	2.20	34	28
CPL7070-101	70	70	10	184	1.82	41	34
CPL8050-101	83	50	10	222	1.45	52	43
CPL8070-101	83	70	10	267	1.30	58	48
CPL10050-101	100	50	10	313	1.20	63	52
CPL10070-101	100	70	10	377	1.03	73	61
CPL12050-101	120	50	10	440	1.06	71	59
CPL12070-101	120	70	10	530	0.88	85	71
CPL14050-101	140	50	10	675	0.90	83	69
CPL14070-101	140	70	10	807	0.77	97	81
CPL16070-101	160	70	10	1060	0.68	110	92

## Notes

- Thermal testing is performed in open air. Results in a closed environment will vary. Cooliance recommends that each application is tested.
- \*Power Dissipation (watts) calculation assumes an LED case temperature of 85°C and an LED input power to output power conversion efficiency of 80%.
- Custom versions of this product are available upon request.

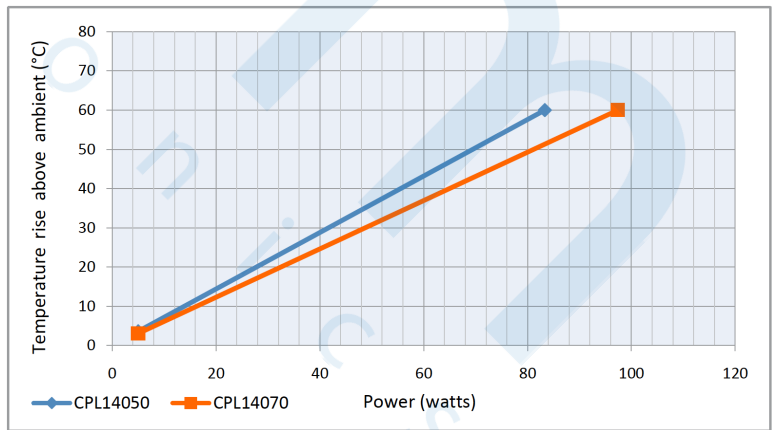
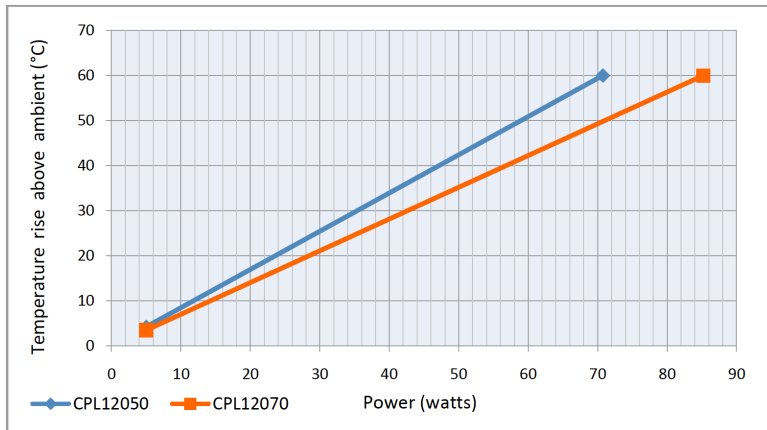
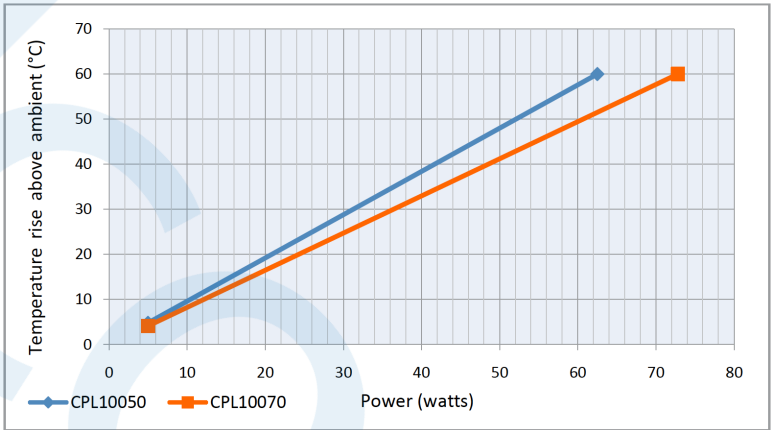
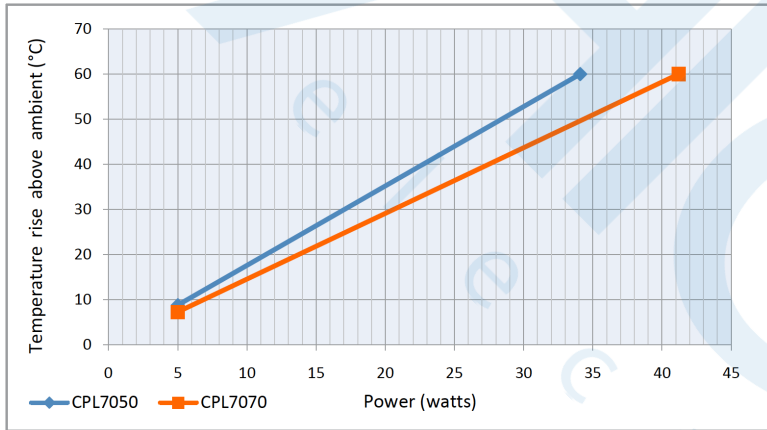
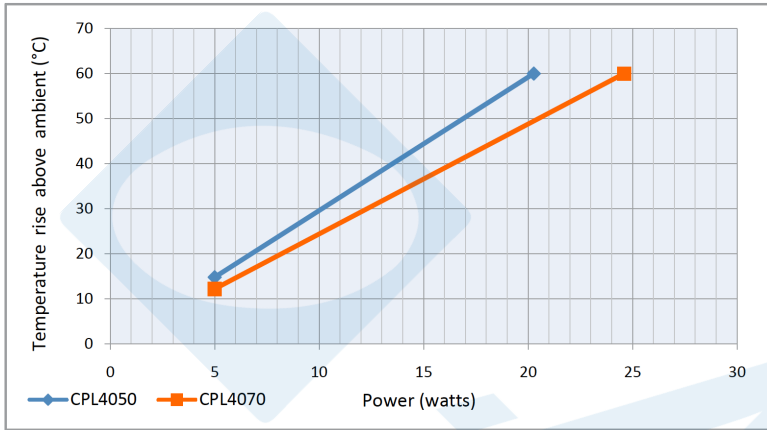

# CPL Series, Passive

## Thermal Performance Charts

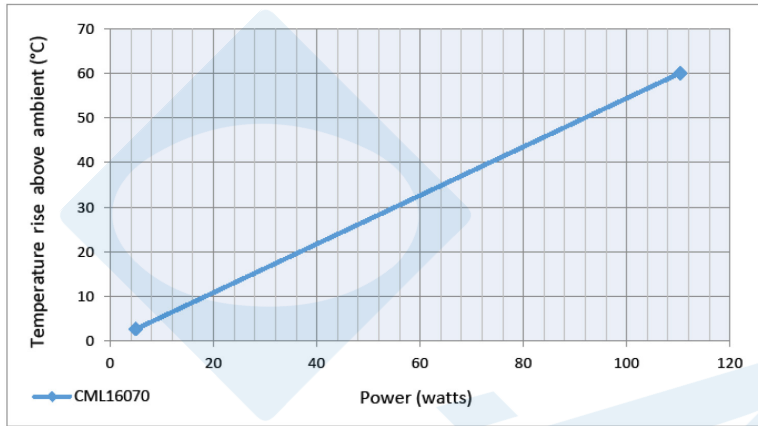

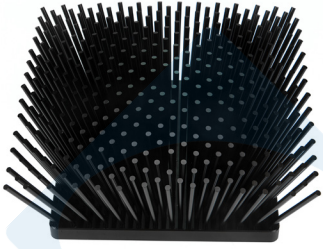

## Features

- Solid one-piece forged aluminum construction for maximum thermal conductivity.
- Pin fin design maximizes surface area and provides omnidirectional cooling to eliminate concerns about the orientation of the heat sink (unlike a linear extrusion).
- Precision-machined at base ensures consistent contact between the heat sink, interface and LED substrate to maximize heat transfer.
- The standard 10mm base thickness allows for full recommended depth for mounting holes.
- Blank mounting surface. (If you require a hole mounting pattern for a specific LED, please refer to our website).

Model	Base Size (mm)	Top Size (mm)	Height (mm)	Base Thickness (mm)	Weight (g)	Thermal Resistance (°C/W)	Power Dissipation (W)*	
							Ambient 25°C	Ambient 35°C
CPL12770QF-101	127 x 127	160 x 160	70	10	800	0.66	114	95

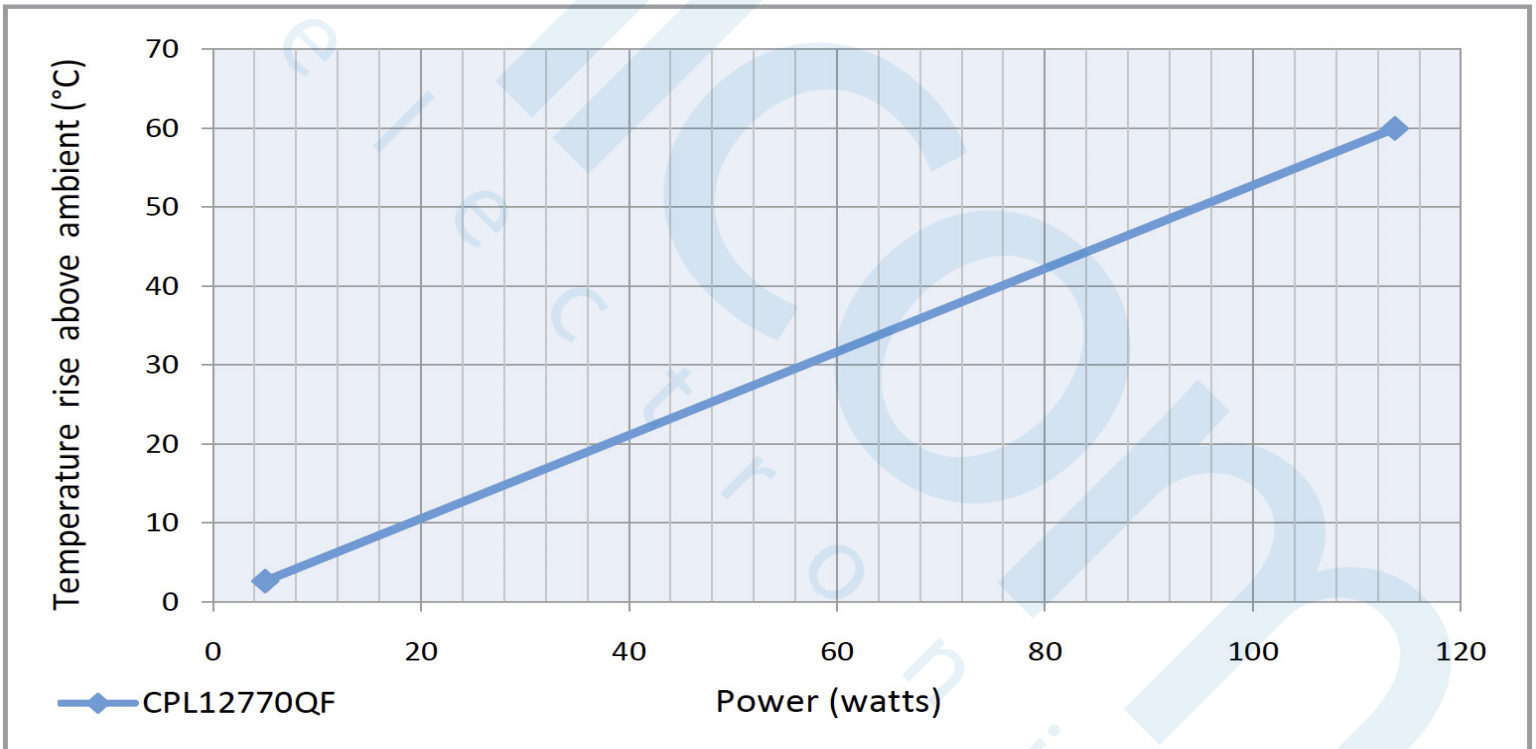

## Notes

- Thermal testing is performed in open air. Results in a closed environment will vary. Cooliance recommends that each application is tested.
- \*Power Dissipation (watts) calculation assumes an LED case temperature of 85°C and an LED input power to output power conversion efficiency of 80%.
- Custom versions of this product are available upon request.

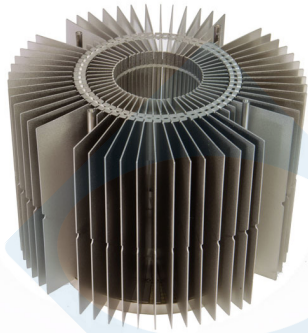

## Features

- Solid, proven, bonded fin technology for maximum thermal conductivity.
- Brush nickel plated or black e-coating for superior corrosion resistance and excellent aesthetics.
- Precision-machined flat base ensures consistent contact between the heat sink, interface and LED substrate to maximize heat transfer.
- 7mm to 10mm base thickness allows for unlimited hole positioning with full recommended depth for mounting holes.
- Optional mounting posts\*\*\*\*, shipped independent of the heatsink, for Meanwell HBG series or Inventronics EUR series drivers.
- Blank mounting surface. (If you require a hole mounting pattern for a specific LED, please refer to our website).

Model	Diameter (mm)	Height (mm)	Base Thickness (mm)	Weight (g)	Thermal Resistance (°C/W)	Power Dissipation (W)***	
						Ambient 25°C	Ambient 35°C
CHP150-101 or -101B*	200	**95/107	10	1300	0.37	205	171
CHP200-101 or -101B*	200	**153/162	10	1780	0.33	227	189
CHP250-101 or -101B*	200	**150/160	7	2020	0.30	250	208

## Notes

- Thermal testing is performed in open air. Results in a closed environment will vary. Cooliance recommends that each application is tested.
- \* Heatsinks are available in Brush Nickel plated (-101) or Black E-coating (-101B)
- \*\*Height column provides dimensions for the heatsink and the heatsink assembled with mounting posts.
- \*\*\*Power Dissipation (watts) calculation assumes an LED case temperature of 85°C and an LED input power to output power conversion efficiency of 80%.
- CHP250 base contains copper heat pipes to increase thermal conduction (as seen as below).
- CHP250 requires additional mounting holes for posts (4) to mount Meanwell HBG-240 series or Inventronics EUR-240 series drivers
- Custom versions of this product are available upon request.





# CHP Series, Passive

## Thermal Performance Chart

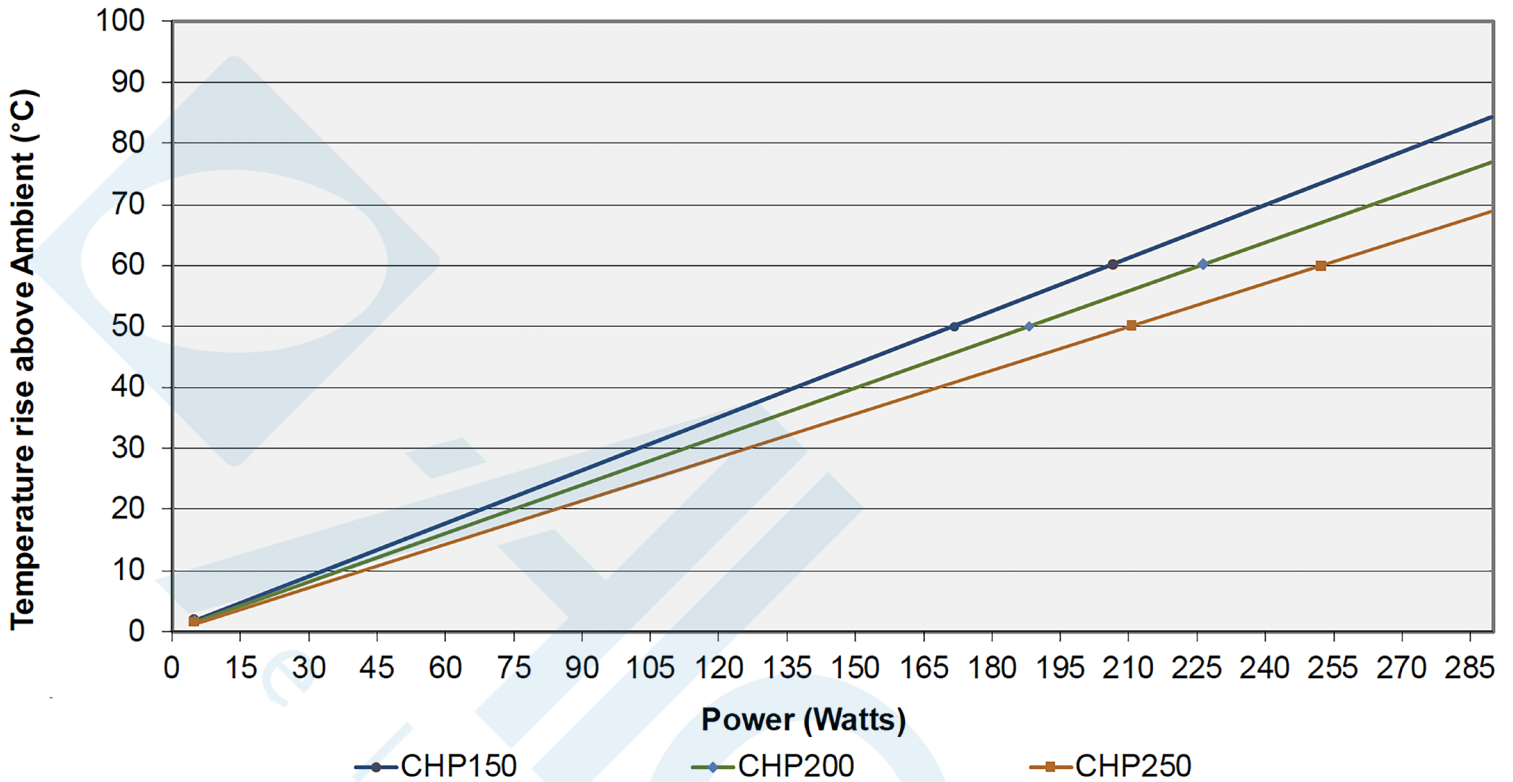

Model	Dimensions (mm)						
	A	B	C	D	E	F	G
CHP150-101 or -101B*	132	200	150	10	95	97	105
CHP200-101 or -101B*	132	200	150	10	153	153	159
CHP250-101 or -101B*	132	200	200	7	150	153	159

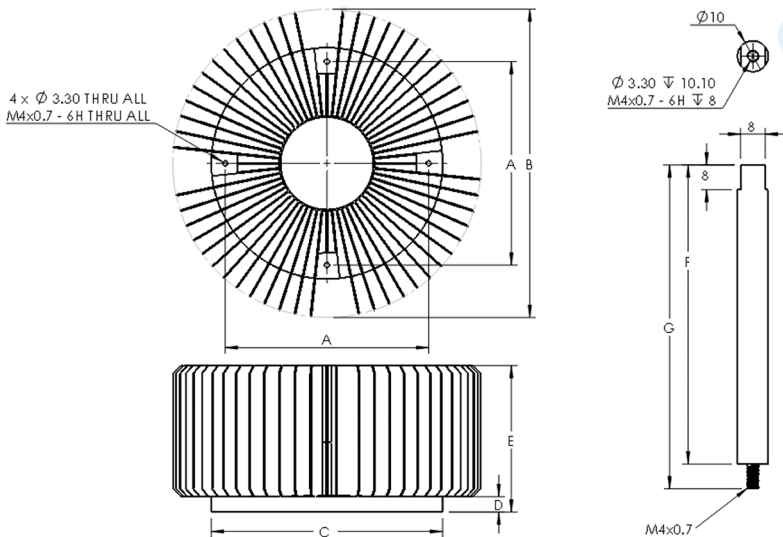

Ordering Information		
Heatsink	Post (4)****	Color
CHP150-101	CHP-POST-1	Brushed Nickel
CHP150-101B	CHP-POST-1B	Black E-Coat
CHP200-101	CHP-POST-2	Brushed Nickel
CHP200-101B	CHP-POST-2B	Black E-Coat
CHP250-101	CHP-POST-2	Brushed Nickel
CHP250-101B	CHP-POSRT-2B	Black E-Coat

## Features



- Capable of cooling up to 117 Watts.
- No separate power supply required.
- Operating life exceeds 60,000 hours at 45°C.
- A broad range of input voltages from 11V to 75V.
- UL File #E351120 applies up to 60V input voltage
- The standard 10mm base thickness allows for full recommended depth for mounting holes.
- 5 Year Limited Warranty.
- Inaudible (<16dB noise level) at super quiet setting.
- Ability to select three fan speed settings to control thermal performance and noise.
- Integral mounting features to support attachment luminaire.
- Blank mounting surface. (If you require a hole mounting pattern for a specific LED, please refer to our website).

Model	Setting	dbA	Diameter (mm)	Height (mm)	Base Thickness (mm)	Weight (g)	Thermal Resistance (°C/W)	Power Dissipation (W)*	
								Ambient 25°C	Ambient 35°C
CSL5025SQ-101	Super Quiet	16	50	60	10	130	1.50	50	42
CSL5025Q-101	Quiet	20	50	60	10	130	1.10	68	57
CSL5025MP-101	Max. Performance	26	50	60	10	130	0.85	88	74
CSL5050SQ-101	Super Quiet	16	50	85	10	160	1.15	65	54
CSL5050Q-101	Quiet	20	50	85	10	160	0.85	88	74
CSL5050MP-101	Max. Performance	26	50	85	10	160	0.67	112	93
CSL5070SQ-101	Super Quiet	16	50	105	10	190	1.10	68	57
CSL5070Q-101	Quiet	20	50	105	10	190	0.80	94	78
CSL5070MP-101	Max. Performance	26	50	105	10	190	0.64	117	98

## Notes

- Thermal resistance values are given as a reference only and are measured in free air without airflow obstructions. Thermal resistance is measured from the bottom middle of the heat sink to ambient air. Actual thermal performance may vary by application, and final product design should be tested to assure proper thermal performance.
- Thermal design is based on the cooling a typical LED array's case temperature. Values are based on a temperature rise of 60°C or 50°C.

# CSL 750 Series, Active

## Connection Diagram

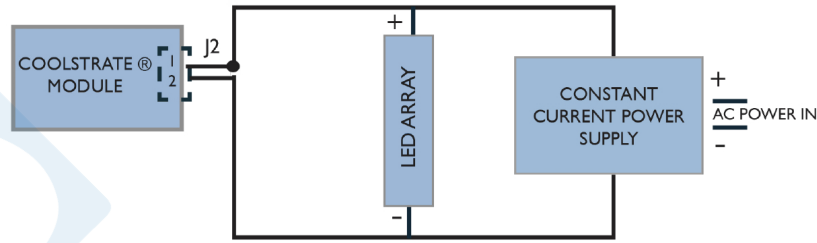

## Power Consumption (Watts)

Setting	Input Voltage							
	12V	15V	20V	25V	30V	35V	40V	42V
Super Quiet	0.48	0.48	0.48	0.50	0.51	0.53	0.53	0.55
Quiet	0.74	0.74	0.74	0.75	0.75	0.77	0.80	0.80
Max. Performance	*	1.30	1.30	1.30	1.30	1.30	1.28	1.26

\*MP option requires a minimum of 15V

## Thermal Performance Chart

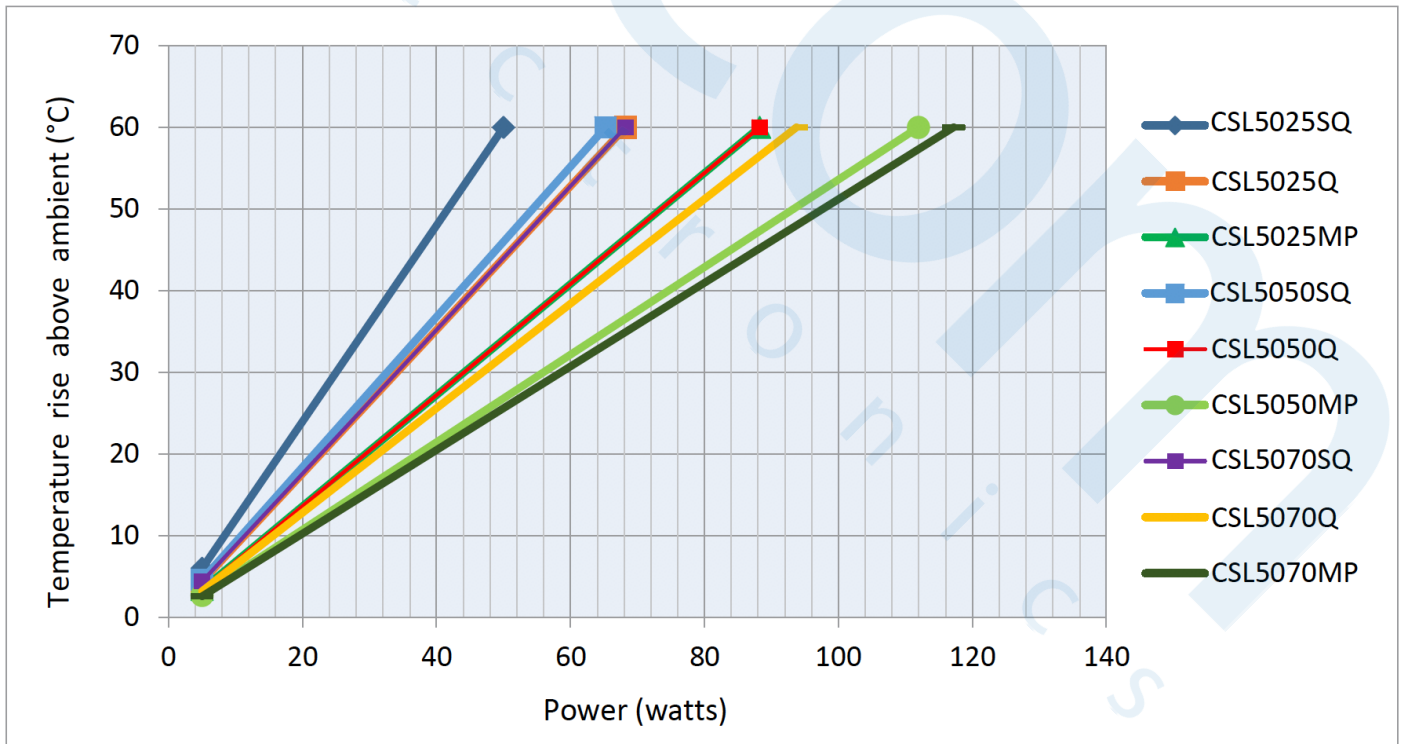

## Wire Harness Options

Part Number	Length (mm)	Pin	Wire Color	Symbol
CSLWH12	300	1	Red	+VDC
		2	Black	GND
CSLWH18	450	1	Red	+VDC
		2	Black	GND

Wire Connections	
Pin 1	Positive DC Ground
Pin 2	Ground
Input Connector	JST Part# PHR-2



## Mechanical Dimensions

Model	A (mm)	B (mm)	C (mm)
CSL5025	60	60	50
CSL5050	85	60	50
CSL5070	105	60	50

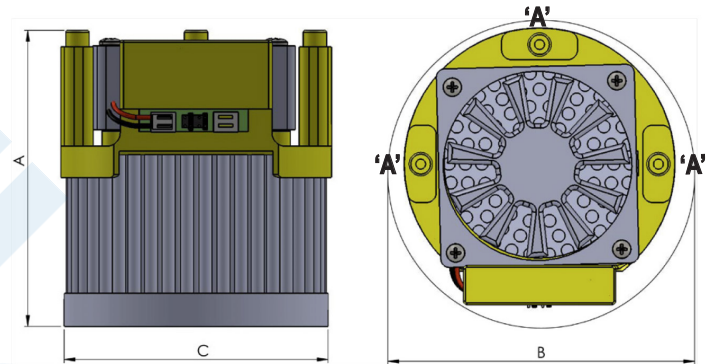



### THREE SCREWS 'A'

- Delta PT 30 or equivalent screw
- Limit installation torque to 0.40Nm @ 400 rpm
- Boss designed for 250 lb Pull-out force

## COOLSTRATE CONFIGURATIONS

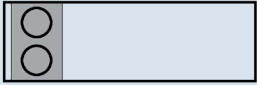
Coolstrate modules are factory configured for Quiet (Q) settings. The Coolstrate module may be configured per the three settings by moving the jumpers in the following configurations. The drawing as shown is referenced with the LED pointing down towards the ground.

Setting	Jumper Positions
Quiet	
Super Quiet	
Max. Performance	

## Operating Modes And Descriptions

### COOLSTRATE MODULE

The Coolstrate module consists of a controller circuit, a special low noise, high efficiency, long life fan and an ultra-low thermal resistance heat sink. The controller circuit converts any input voltage from 11 to 75 volts to a fixed lower voltage as required by the fan. The input voltage is derived from the same voltage used to power the LED array.

### OVERTEMP PROTECTION

Contact Cooliance Tech Support for further information and customized dimming and overtemp protection support.

### DIMMING

Dimming should not affect the thermal performance of the Coolstrate unit. In most applications, the voltage output from a dimmed power supply will still be higher than the minimum input voltage of the Coolstrate unit and therefore its thermal operation will be unaffected. Should dimming of the LED power supply reduce the voltage output to below that of the Coolstrate minimum voltage input, the Coolstrate module will not be adversely affected and will continue to operate until the voltage reaches a point at which the fan turns off. At that point, the power output of the LEDs is at a reduced level, and the Coolstrate heat sink is typically capable of providing adequate cooling in a passive mode. As the dimming level increases back to full power, the Coolstrate module will also turn back on and function as an active unit. Please consult factory for support with a specific dimmer and application.

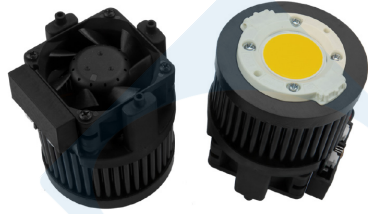

## Features

- Capable of cooling up to 326 Watts.
- No separate power supply required.
- Operating life exceeds 60,000 hours at 45°C.
- A broad range of input voltages from 11V to 75V.
- UL File #E351120 applies up to 60V input voltage
- The standard 10mm base thickness allows for full recommended depth for mounting holes.
- 5 Year Limited Warranty.
- Inaudible (<16dB noise level) at super quiet setting.
- Ability to select three fan speed settings to control thermal performance and noise.
- Blank mounting surface. (If you require a hole mounting pattern for a specific LED, please refer to our website).

Model	Setting	dbA	Diameter (mm)	Height (mm)	Base Thickness (mm)	Weight (g)	Thermal Resistance (°C/W)	Power Dissipation (W)*	
								Ambient 25°C	Ambient 35°C
CSL8025SQ-101	Super Quiet	16	80	64	10	340	0.80	94	78
CSL8025Q-101	Quiet	20	80	64	10	340	0.65	115	96
CSL8025MP-101	Max. Performance	34	80	64	10	340	0.43	174	145
CSL8050SQ-101	Super Quiet	16	80	92	10	480	0.50	150	125
CSL8050Q-101	Quiet	20	80	92	10	480	0.40	188	156
CSL8050MP-101	Max. Performance	34	80	92	10	480	0.27	278	231
CSL8070SQ-101	Super Quiet	16	80	110	10	570	0.47	160	133
CSL8070Q-101	Quiet	20	80	110	10	570	0.35	214	179
CSL8070MP-101	Max. Performance	34	80	110	10	570	0.23	326	272

## Notes

- Thermal resistance values are given as a reference only and are measured in free air without airflow obstructions. Thermal resistance is measured from the bottom middle of the heat sink to ambient air. Actual thermal performance may vary by application, and final product design should be tested to assure proper thermal performance.
- Thermal design is based on the cooling a typical LED array's case temperature. Values are based on a temperature rise of 60°C or 50°C.

## Connection Diagram

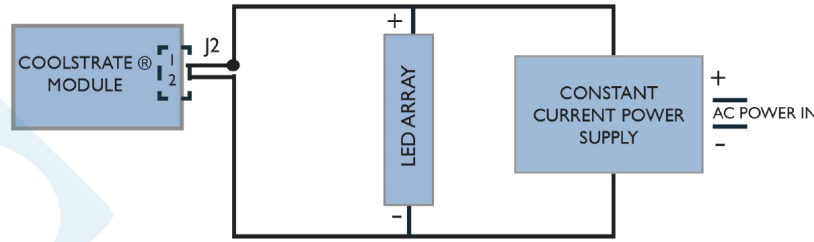

## Power Consumption (Watts)

Setting	Input Voltage							
	12V	15V	20V	25V	30V	35V	40V	42V
Super Quiet	0.46	0.45	0.46	0.48	0.48	0.49	0.52	0.50
Quiet	0.80	0.78	0.80	0.78	0.78	0.80	0.80	0.80
Max. Performance	*	1.88	2.00	1.98	2.07	2.03	2.04	2.02

\*MP option requires a minimum of 15V

## Thermal Performance Chart

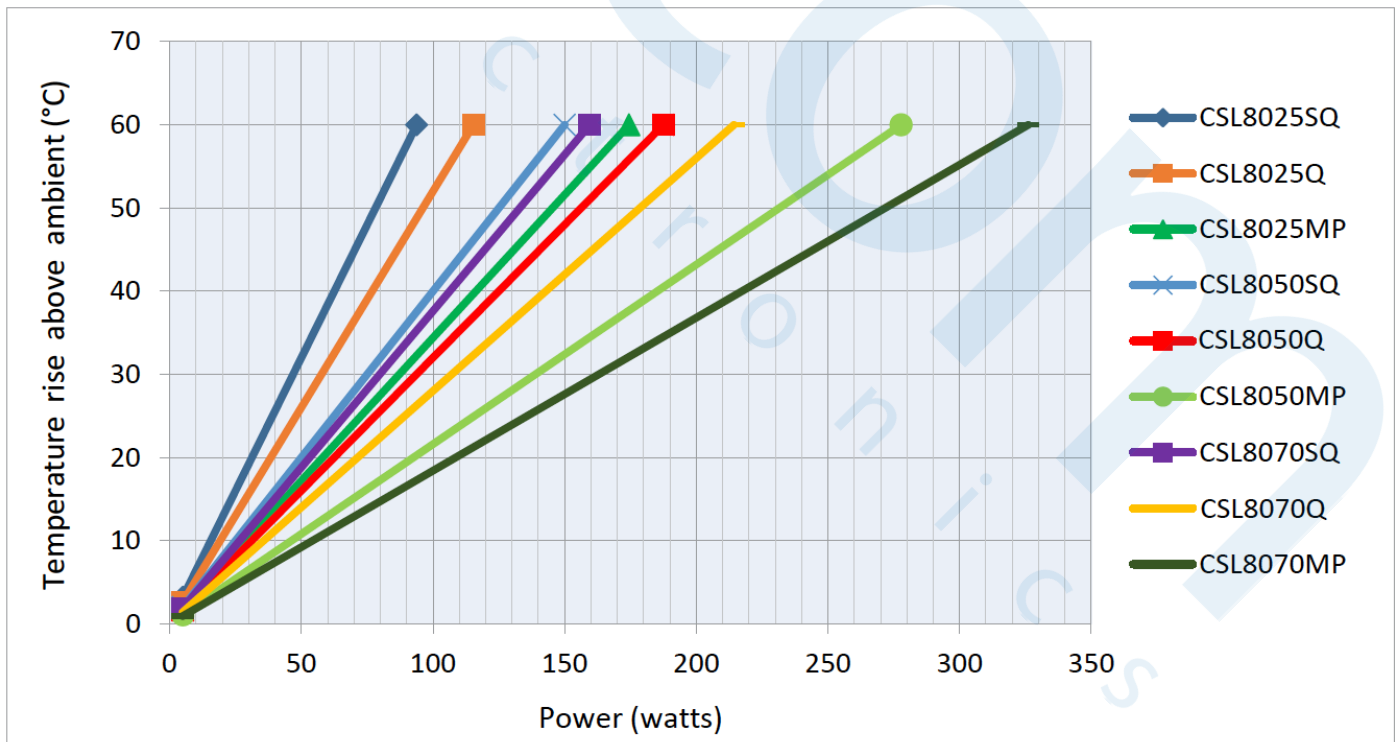

## Wire Harness Options

Part Number	Length (mm)	Pin	Wire Color	Symbol
CSLWH12	300	1	Red	+VDC
		2	Black	GND
CSLWH18	450	1	Red	+VDC
		2	Black	GND

Wire Connections	
Pin 1	Positive DC Ground
Pin 2	Ground
Input Connector	JST Part# PHR-2



### COOLSTRATE CONFIGURATIONS

Coolstrate modules are factory configured for Quiet (Q) settings. The Coolstrate module may be configured per the three settings by moving the jumpers in the following configurations. The drawing as shown is referenced with the LED pointing down towards the ground.

## Operating Modes And Descriptions

### COOLSTRATE MODULE

The Coolstrate module consists of a controller circuit, a special low noise, high efficiency, long life fan and an ultra low thermal resistance heat sink. The controller circuit converts any input voltage from 11 to 75 volts to a fixed lower voltage as required by the fan. The input voltage is derived from the same voltage used to power the LED array.

### OVERTEMP PROTECTION

Contact Cooliance Tech Support for further information and customized dimming and overtemp protection support.

### DIMMING

Dimming should not affect the thermal performance of the Coolstrate unit. In most applications, the voltage output from a dimmed power supply will still be higher than the minimum input voltage of the Coolstrate unit and therefore its thermal operation will be unaffected. Should dimming of the LED power supply reduce the voltage output to below that of the Coolstrate minimum voltage input, the Coolstrate module will not be adversely affected and will continue to operate until the voltage reaches a point at which the fan turns off. At that point, the power output of the LEDs is at a reduced level and the Coolstrate heat sink is typically capable of providing adequate cooling in a passive mode. As the dimming level increases back to full power, the Coolstrate module will also turn back on and function as an active unit. Please consult factory for support with a specific dimmer and application.

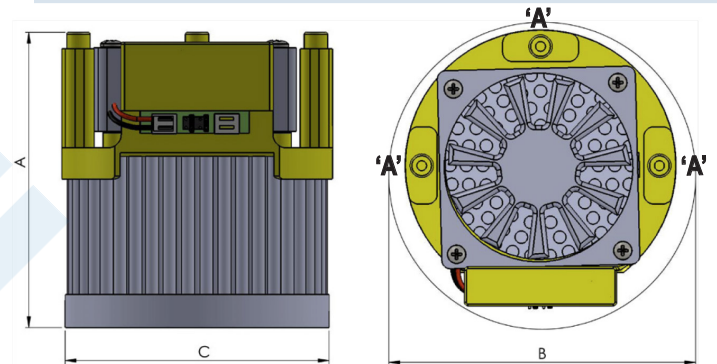

## Mechanical Dimensions

Model	A (mm)	B(mm)	C(mm)
CSL8025	64	85	80
CSL8050	92	85	80
CSL8070	110	85	80



### THREE SCREWS 'A'

- Delta PT 30 or equivalent screw
- Limit installation torque to 0.40Nm @ 400 rpm
- Boss designed for 250 lb Pull-out force

Setting	Jumper Positions
Quiet	
Super Quiet	
Max. Performance	

## Features

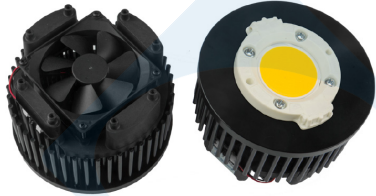

- Capable of cooling up to 500 Watts.
- No separate power supply required.
- Operating life exceeds 60,000 hours at 45°C.
- A broad range of input voltages from 11V to 75V.
- UL File #E351120 applies up to 60V input voltage
- The standard 10mm base thickness allows for full recommended depth for mounting holes.
- 5 Year Limited Warranty.
- Inaudible (<16dB noise level) at super quiet setting.
- Ability to select three fan speed settings to control thermal performance and noise.
- Blank mounting surface. (If you require a hole mounting pattern for a specific LED, please refer to our website).

Model	Setting	dbA	Diameter (mm)	Height (mm)	Base Thickness (mm)	Weight (g)	Thermal Resistance (°C/W)	Power Dissipation (W)*	
								Ambient 25°C	Ambient 35°C
CSL16070SQ-101	Super Quiet	16	160	110	10	1,200	0.22	341	284
CSL16070Q-101	Quiet	22	160	110	10	1,200	0.19	395	329
CSL16070MP-101	Max. Performance	32	160	110	10	1,200	0.15	500	419

## Notes

- Thermal resistance values are given as a reference only and are measured in free air without airflow obstructions. Thermal resistance is measured from the bottom middle of the heat sink to ambient air. Actual thermal performance may vary by application, and final product design should be tested to assure proper thermal performance.
- Thermal design is based on the cooling a typical LED array's case temperature. Values are based on a temperature rise of 60°C or 50°C.



# CSL 7160 Series, Active

## Connection Diagram

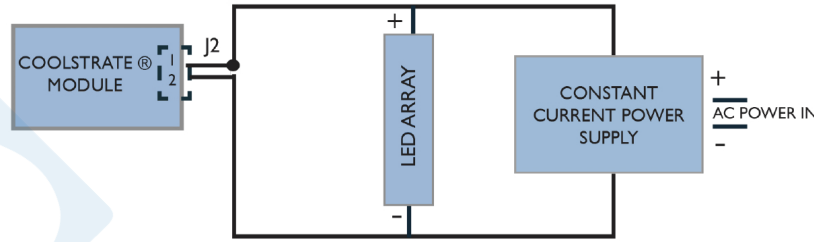

## Power Consumption (Watts)

Setting	Input Voltage							
	12V	15V	20V	25V	30V	35V	40V	42V
Super Quiet	0.74	0.74	0.74	0.75	0.78	0.49	0.80	0.79
Quiet	1.44	1.17	1.16	1.72	0.78	1.20	1.20	1.22
Max. Performance	*	2.03	2.00	2.00	2.07	2.10	2.00	2.10

\*MP option requires a minimum of 15V

## Thermal Performance Chart

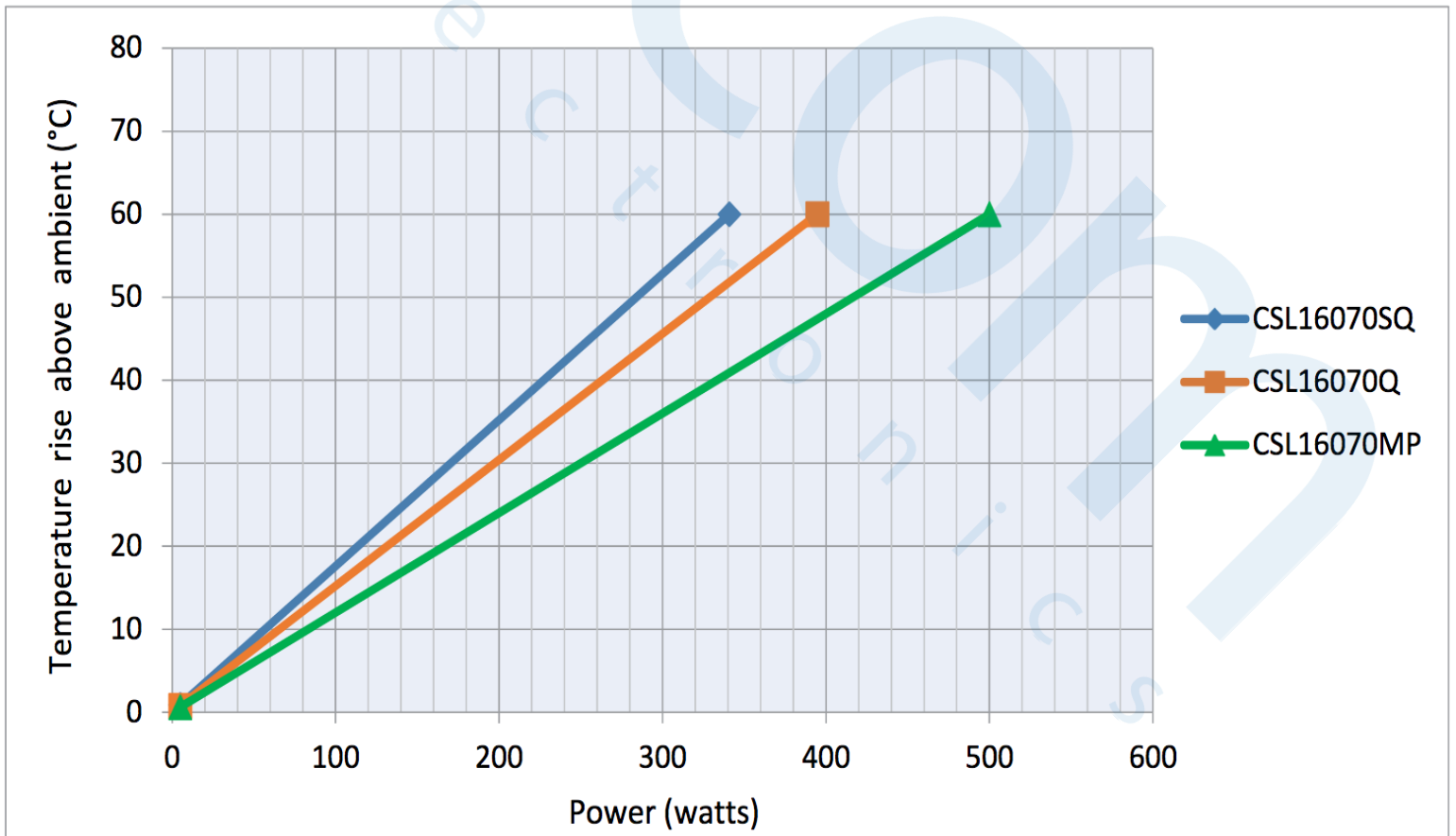

## Wire Harness Options

Part Number	Length (mm)	Pin	Wire Color	Symbol
CSLWH12	300	1	Red	+VDC
		2	Black	GND
CSLWH18	450	1	Red	+VDC
		2	Black	GND

Wire Connections	
Pin 1	Positive DC Ground
Pin 2	Ground
Input Connector	JST Part# PHR-2



## Mechanical Dimensions

Model	A (mm)	B (mm)	C (mm)
CSL16070	110	160	160

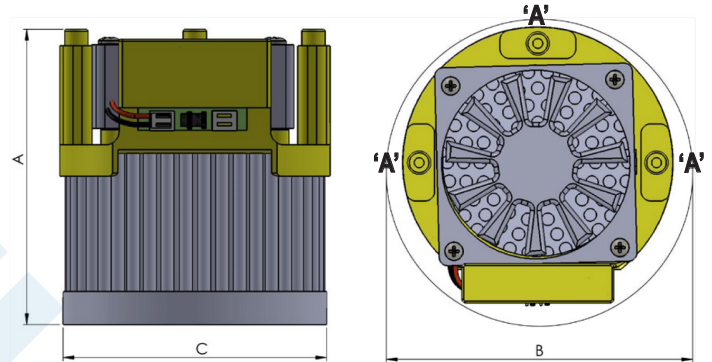



### THREE SCREWS 'A'

- Delta PT 30 or equivalent screw
- Limit installation torque to 0.40Nm @ 400 rpm
- Boss designed for 250 lb Pull-out force

## COOLSTRATE CONFIGURATIONS

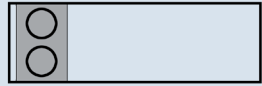
Coolstrate modules are factory configured for Quiet (Q) settings. The Coolstrate module may be configured per the three settings by moving the jumpers in the following configurations. The drawing as shown is referenced with the LED pointing down towards the ground.

Setting	Jumper Positions
Quiet	
Super Quiet	
Max. Performance	

## Operating Modes And Descriptions

### COOLSTRATE MODULE

The Coolstrate module consists of a controller circuit, a special low noise, high efficiency, long life fan and an ultra-low thermal resistance heat sink. The controller circuit converts any input voltage from 11 to 75 volts to a fixed lower voltage as required by the fan. The input voltage is derived from the same voltage used to power the LED array.

### OVERTEMP PROTECTION

Contact Cooliance Tech Support for further information and customized dimming and overtemp protection support.

### DIMMING

Dimming should not affect the thermal performance of the Coolstrate unit. In most applications, the voltage output from a dimmed power supply will still be higher than the minimum input voltage of the Coolstrate unit, and therefore its thermal operation will be unaffected. Should dimming of the LED power supply reduce the voltage output to below that of the Coolstrate minimum voltage input, the Coolstrate module will not be adversely affected and will continue to operate until the voltage reaches a point at which the fan turns off. At that point, the power output of the LEDs is at a reduced level and the Coolstrate heat sink is typically capable of providing adequate cooling in a passive mode. As the dimming level increases back to full power, the Coolstrate module will also turn back on and function as an active unit. Please consult factory for support with a specific dimmer and application.