

35.0 x 5.0 x 4.0 (mm) LTE Full-Band Ceramic Chip Antenna (CC35D8) Engineering Specification

1. Product Number

H 2 U E 3 P 2 D 2 G 0 1 0 0



2. Features

- * Compatible with LTE full-band/ 3G/ 2G
- * Stable and reliable in performances
- * Compact size
- * RoHS2.0 compliance
- * SMT processes compatible
- * [AEC-Q200 compliant](#)

3. Applications

- * LTE full-band/ 3G/ 2G.
- * LTE / GSM / CDMA /DCS /PCS / WCDMA / UMTS / HSDPA / GPRS / EDGE /IMT.

4. Description

Unictron's CC35D8 ceramic chip antenna is designed for cellular 2G/ 3G/ LTE bands applications, covering frequencies 698~960 MHz & 1710~2690 MHz. Fabricated with proprietary design and processes, CC35D8 shows excellent performance and is fully compatible with SMT processes which can decrease the assembly cost and improve device's quality and consistency.

Unictron
Technologies Corp.

2020-07-07

Document
Control Centre



詠業科技股份有限公司
Unictron Technologies Corporation
Website: www.unictron.com

THIS DRAWINGS AND SPECIFICATIONS ARE THE PROPERTY OF UNICTRON TECHNOLOGIES CORPORATION AND SHALL NOT BE REPRODUCED OR USED AS THE BASIS FOR THE MANUFACTURE OR SALE OF APPARATUS OR DEVICES WITHOUT PERMISSION

Prepared by : Jane

Designed by : Tom

Checked by : Mike

Approved by : Herbert

5. Layout Guide & Electrical Specifications

5-1. Layout Guide (Unit: mm)

Solder Land Pattern:

The solder land pattern (gold marking areas) is shown below. Recommendation on matching circuit will be provided according to customer's installation conditions.

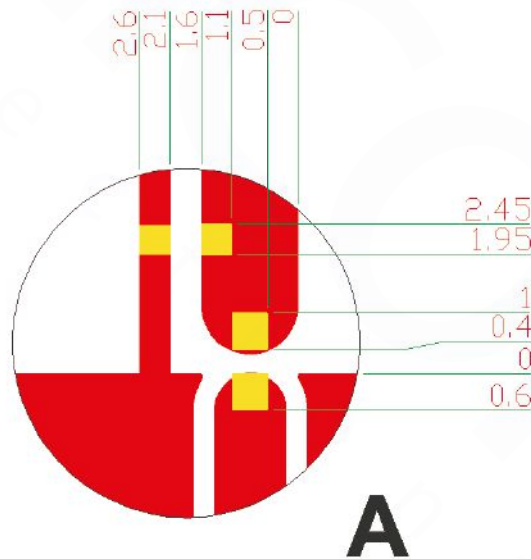
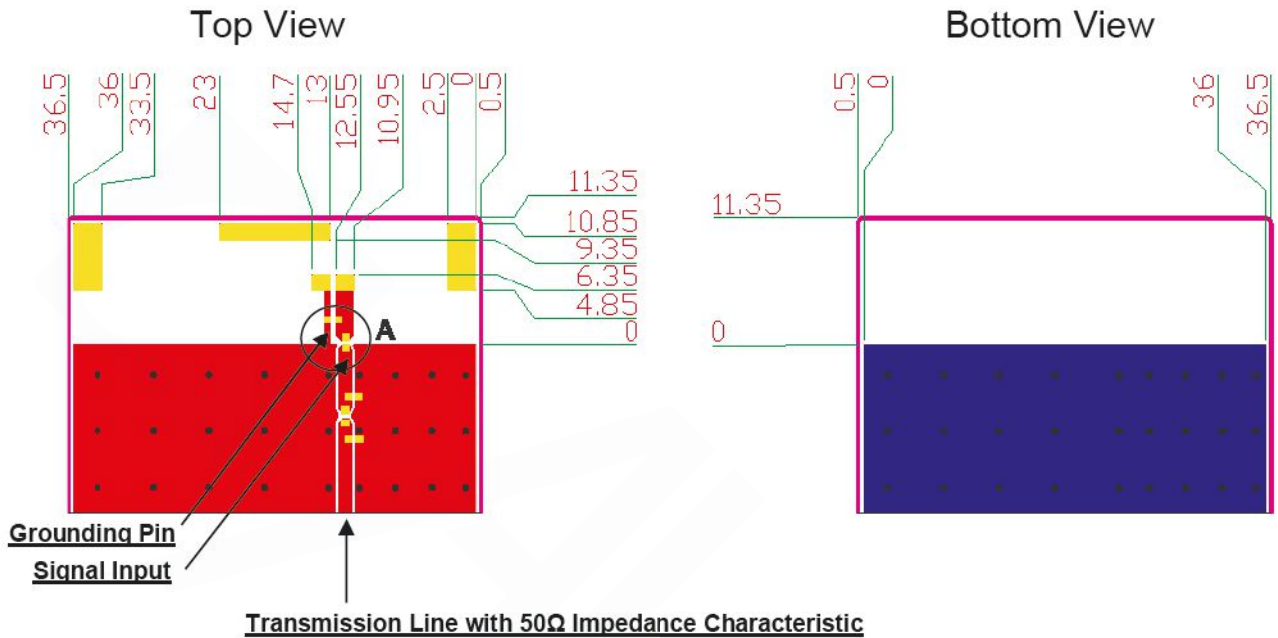

詠業科技股份有限公司
Unictron Technologies Corporation
Website: www.unictron.com

THIS DRAWINGS AND SPECIFICATIONS ARE THE PROPERTY OF UNICTRON TECHNOLOGIES CORPORATION AND SHALL NOT BE REPRODUCED OR USED AS THE BASIS FOR THE MANUFACTURE OR SALE OF APPARATUS OR DEVICES WITHOUT PERMISSION

Prepared by : Jane

Designed by : Tom

Checked by : Mike

Approved by : Herbert

TITLE : 35.0 x 5.0 x 4.0 (mm) LTE Full-Band Ceramic Chip Antenna (CC35D8) Engineering Specification

DOCUMENT NO.

H2UE3P2D2G0100

REV. G

5-2. Electrical Specifications (with 118.5 x 37 mm² Evaluation Board)

5-2-1. Electrical Table

Characteristics	Specifications				
Outline Dimension (mm)	35.0 x 5.0 x 4.0				
Ground Plane Dimension (mm)	107.1 x 37				
Working Frequency (MHz)	698 ~ 798	824 ~ 960	1710 ~ 2170	2300 ~ 2400	2490 ~ 2690
Peak Gain (dBi) (typical)**	1.3	1.0	2.6	4.4	4.2
Efficiency (%) (typical)**	54	58	55	75	65
VSWR (@ center frequency)*	< 3.5 : 1				
Characteristic Impedance (Ω)	50				
Polarization	Linear Polarization				

*Center frequency means the frequency with the lowest value in return loss of the chip antenna on the evaluation board.

**A typical value is for reference only, not guaranteed.

5-2-2. Frequency vs. V.S.W.R. and Total Radiation Gain

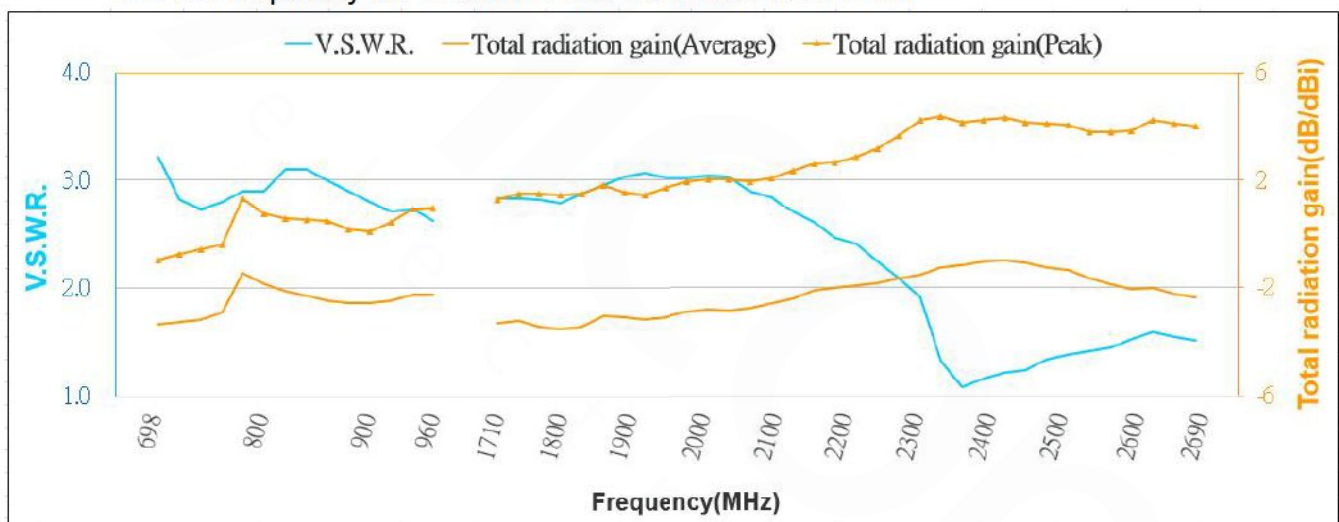

Unictron
Technologies Corp.

2020-07-07

Document

Control Centre



詠業科技股份有限公司
Unictron Technologies Corporation
Website: www.unictron.com

THIS DRAWINGS AND SPECIFICATIONS ARE THE PROPERTY OF UNICTRON TECHNOLOGIES CORPORATION AND SHALL NOT BE REPRODUCED OR USED AS THE BASIS FOR THE MANUFACTURE OR SALE OF APPARATUS OR DEVICES WITHOUT PERMISSION

Prepared by : Jane

Designed by : Tom

Checked by : Mike

Approved by : Herbert

TITLE : 35.0 x 5.0 x 4.0 (mm) LTE Full-Band Ceramic
Chip Antenna (CC35D8) Engineering
Specification

DOCUMENT
NO.

H2UE3P2D2G0100

REV.

G

6. Outline Dimensions of Antenna & Evaluation Board (Unit: mm)

6-1. Antenna Dimensions

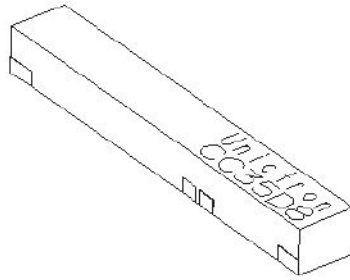

Top View

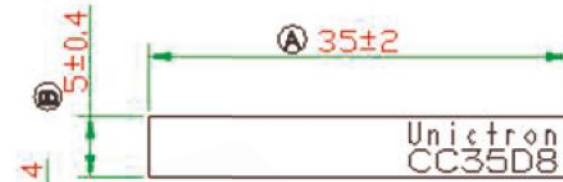

Front View

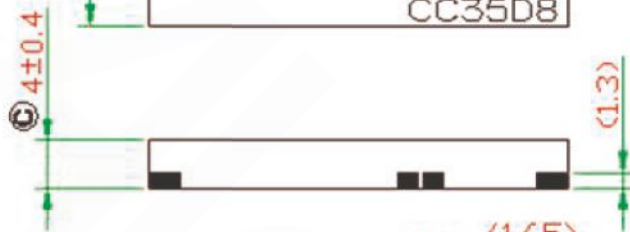

Bottom View

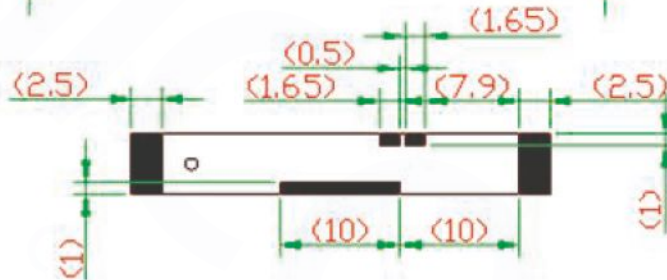

Back View



NOTE:

- 1. All materials are RoHS 2.0 compliant.
- 2. "A~C" Critical Dimensions.
- 3. "()" Reference Dimensions.

Unicon
Technologies Corp.
2020-07-07
Document
Control Center



詠業科技股份有限公司
Unicon Technologies Corporation
Website: www.unicon.com

THIS DRAWINGS AND SPECIFICATIONS ARE THE PROPERTY OF UNICON TECHNOLOGIES CORPORATION AND SHALL NOT BE REPRODUCED OR USED AS THE BASIS FOR THE MANUFACTURE OR SALE OF APPARATUS OR DEVICES WITHOUT PERMISSION

Prepared by : Jane

Designed by : Tom

Checked by : Mike

Approved by : Herbert

TITLE : 35.0 x 5.0 x 4.0 (mm) LTE Full-Band Ceramic Chip Antenna (CC35D8) Engineering Specification

DOCUMENT NO.

H2UE3P2D2G0100

REV. G

PIN Definition

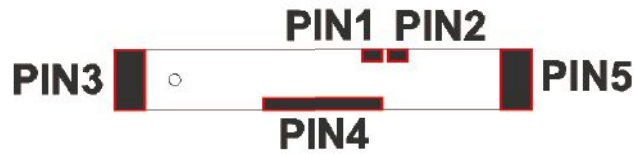

Bottom View

PIN	1	2	3~5
Soldering Pad	Tuning/Ground	Signal	N/C

6-2. Evaluation Board & Antenna Location

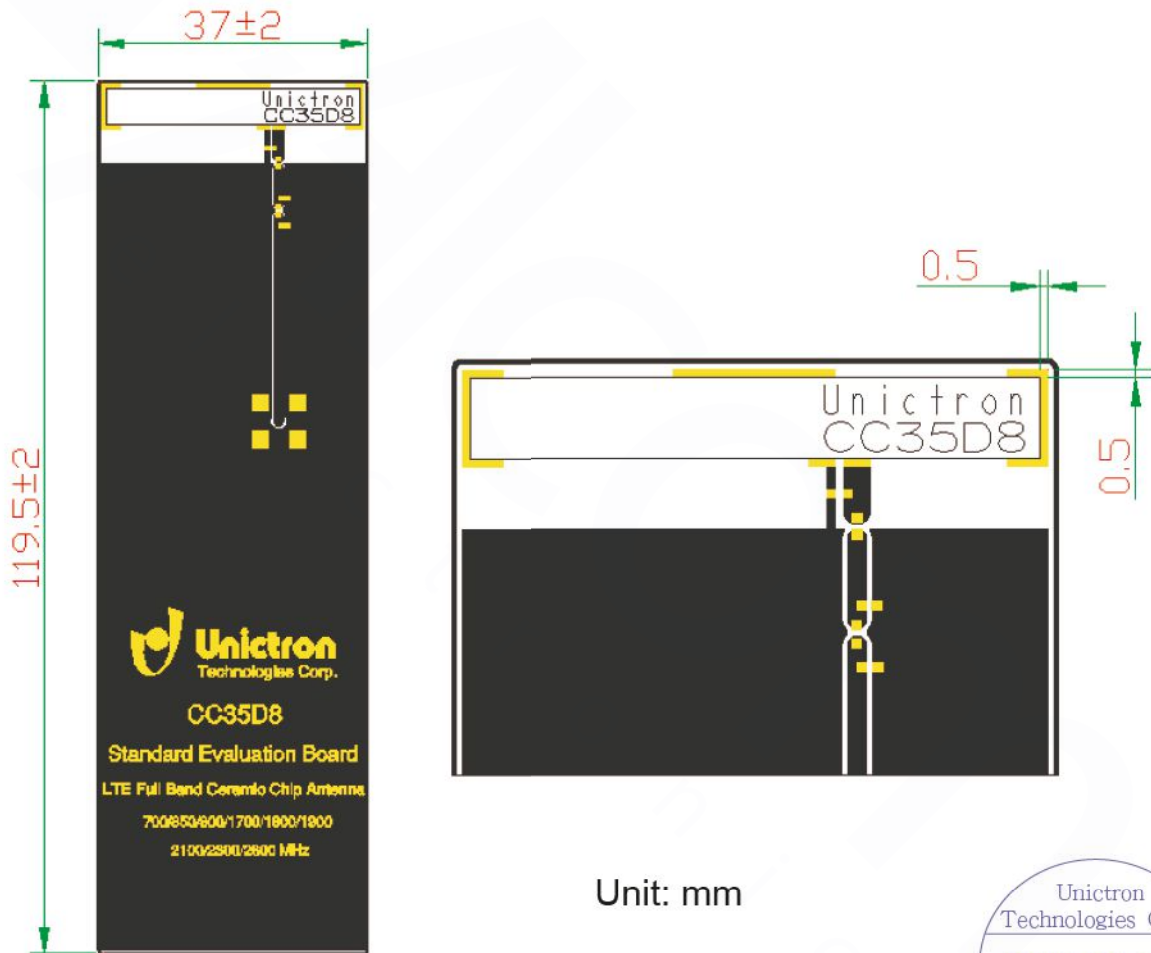

Unit: mm



詠業科技股份有限公司
Unictron Technologies Corporation
Website: www.unictron.com

THIS DRAWINGS AND SPECIFICATIONS ARE THE PROPERTY OF UNICTRON TECHNOLOGIES CORPORATION AND SHALL NOT BE REPRODUCED OR USED AS THE BASIS FOR THE MANUFACTURE OR SALE OF APPARATUS OR DEVICES WITHOUT PERMISSION

Prepared by : Jane Designed by : Tom Checked by : Mike Approved by : Herbert

TITLE : 35.0 x 5.0 x 4.0 (mm) LTE Full-Band Ceramic Chip Antenna (CC35D8) Engineering Specification	DOCUMENT NO.	H2UE3P2D2G0100	REV.
			G

7. 3D Radiation Gain Pattern (with 118.5 x 37 mm² Evaluation Board)

7-1. 698~798MHz Band

3D Radiation Gain Pattern @ 748 MHz (Unit: dBi)

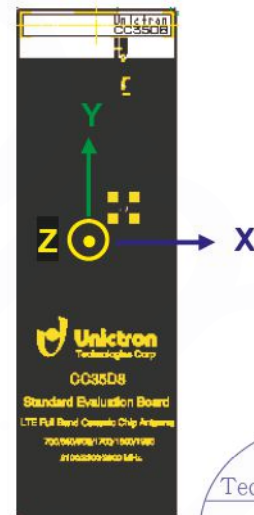
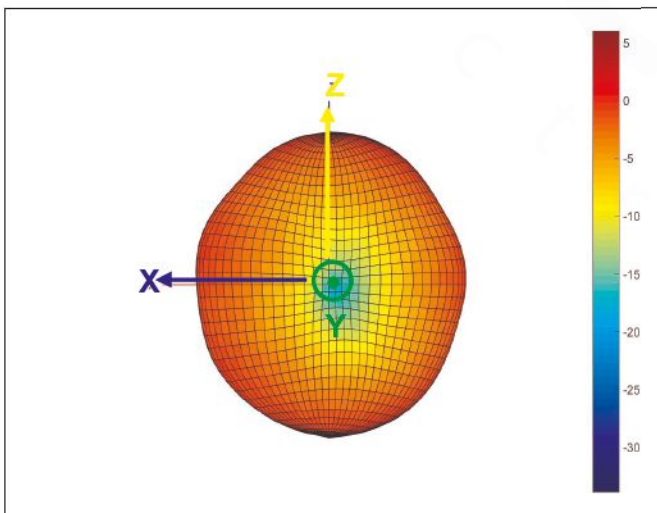
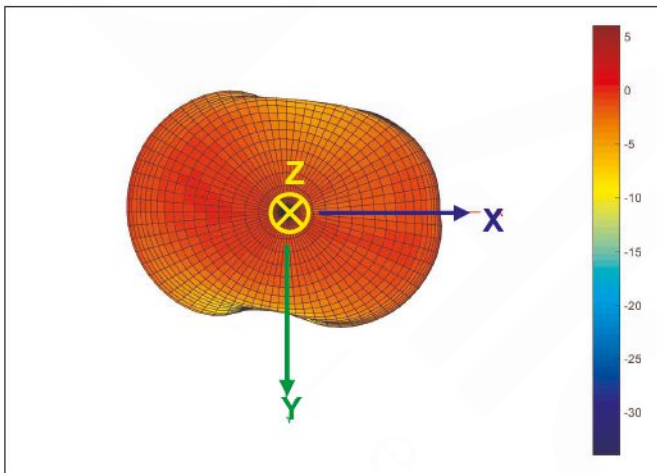
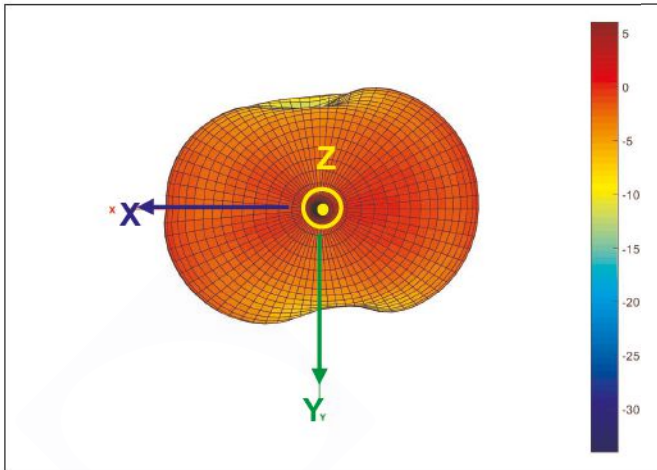

Unicon Technologies Corp.

2020-07-07

Document Control Centre



詠業科技股份有限公司
Unicon Technologies Corporation
Website: www.unicon.com

THIS DRAWINGS AND SPECIFICATIONS ARE THE PROPERTY OF UNICON TECHNOLOGIES CORPORATION AND SHALL NOT BE REPRODUCED OR USED AS THE BASIS FOR THE MANUFACTURE OR SALE OF APPARATUS OR DEVICES WITHOUT PERMISSION

Prepared by : Jane

Designed by : Tom

Checked by : Mike

Approved by : Herbert

TITLE : 35.0 x 5.0 x 4.0 (mm) LTE Full-Band Ceramic Chip Antenna (CC35D8) Engineering Specification

DOCUMENT NO.

H2UE3P2D2G0100

REV.

G

7-2. 824~960MHz Band

3D Radiation Gain Pattern @ 890 MHz (Unit: dBi)

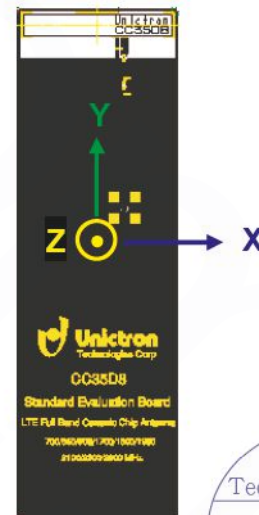
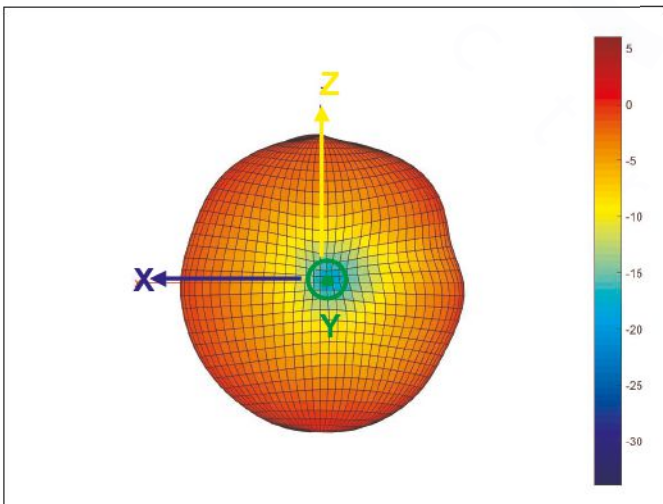
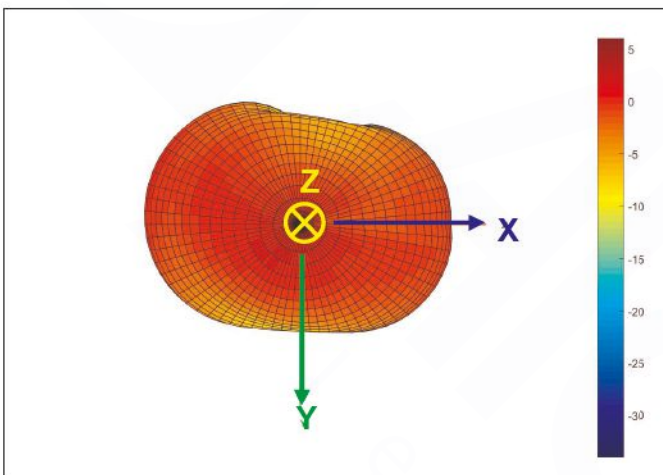
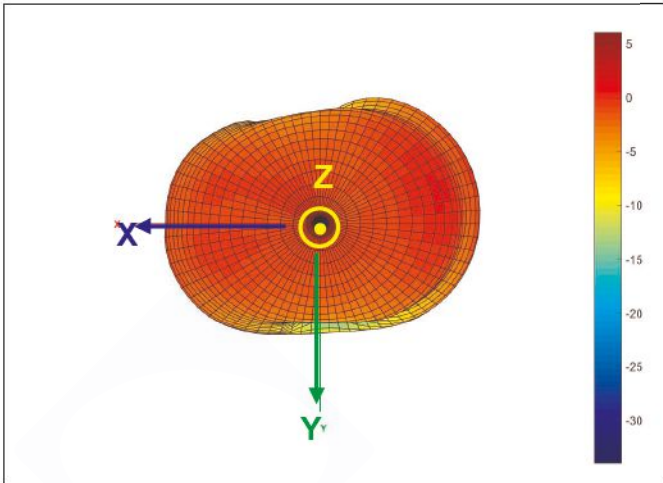

Unicon Technologies Corp.

2020-07-07

Document Control Centre



詠業科技股份有限公司
Unicon Technologies Corporation
Website: www.unicon.com

THIS DRAWINGS AND SPECIFICATIONS ARE THE PROPERTY OF UNICON TECHNOLOGIES CORPORATION AND SHALL NOT BE REPRODUCED OR USED AS THE BASIS FOR THE MANUFACTURE OR SALE OF APPARATUS OR DEVICES WITHOUT PERMISSION

Prepared by : Jane

Designed by : Tom

Checked by : Mike

Approved by : Herbert

TITLE : 35.0 x 5.0 x 4.0 (mm) LTE Full-Band Ceramic Chip Antenna (CC35D8) Engineering Specification

DOCUMENT NO.

H2UE3P2D2G0100

REV.

G

7-3. 1710~2170MHz Band

3D Radiation Gain Pattern @ 1950 MHz (Unit: dBi)

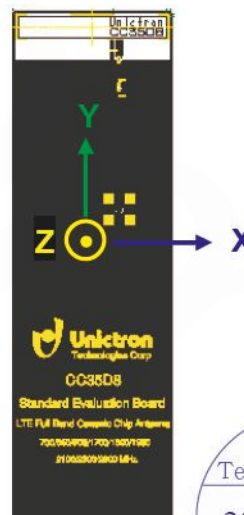
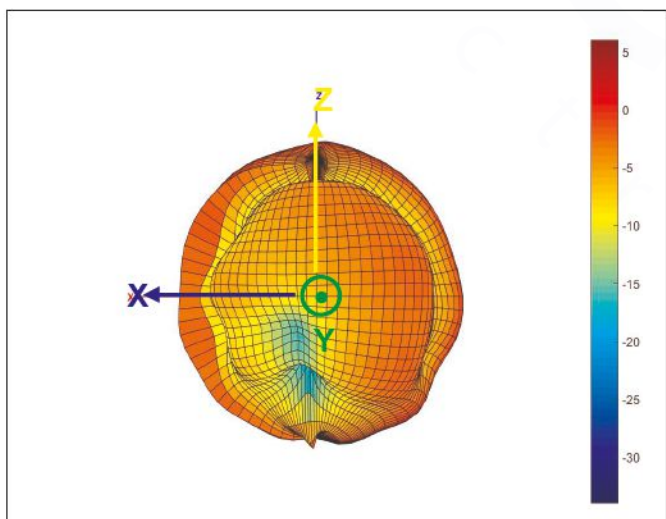
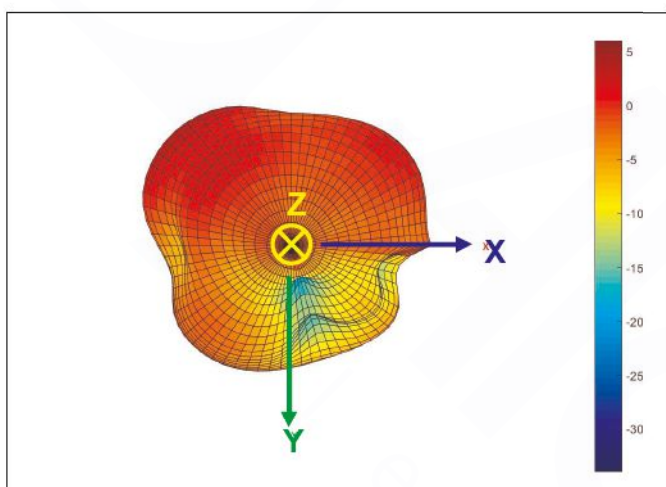
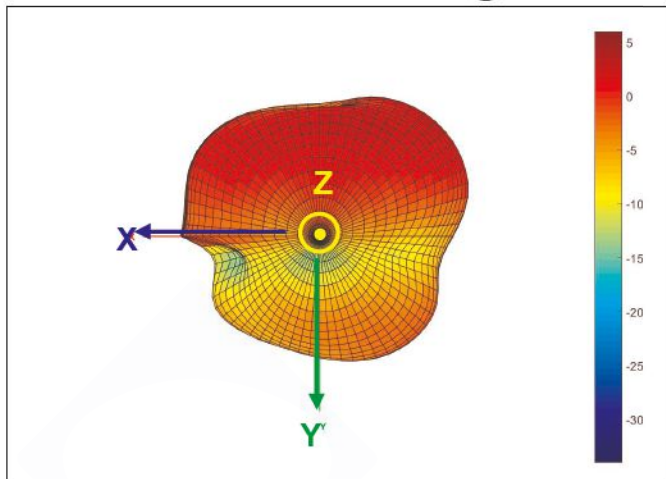

Unictron Technologies Corp.
2020-07-07
Document Control Center



詠業科技股份有限公司
Unictron Technologies Corporation
Website: www.unictron.com

THIS DRAWINGS AND SPECIFICATIONS ARE THE PROPERTY OF UNICTRON TECHNOLOGIES CORPORATION AND SHALL NOT BE REPRODUCED OR USED AS THE BASIS FOR THE MANUFACTURE OR SALE OF APPARATUS OR DEVICES WITHOUT PERMISSION

Prepared by : Jane

Designed by : Tom

Checked by : Mike

Approved by : Herbert

TITLE : 35.0 x 5.0 x 4.0 (mm) LTE Full-Band Ceramic Chip Antenna (CC35D8) Engineering Specification

DOCUMENT NO.

H2UE3P2D2G0100

REV. G

7-4. 2300~2400MHz Band

3D Radiation Gain Pattern @ 2350 MHz (Unit: dBi)

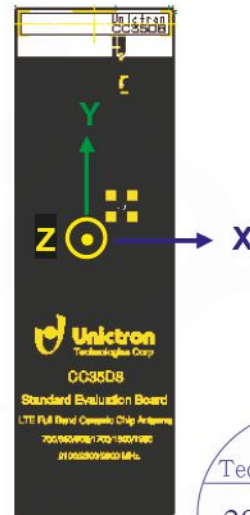
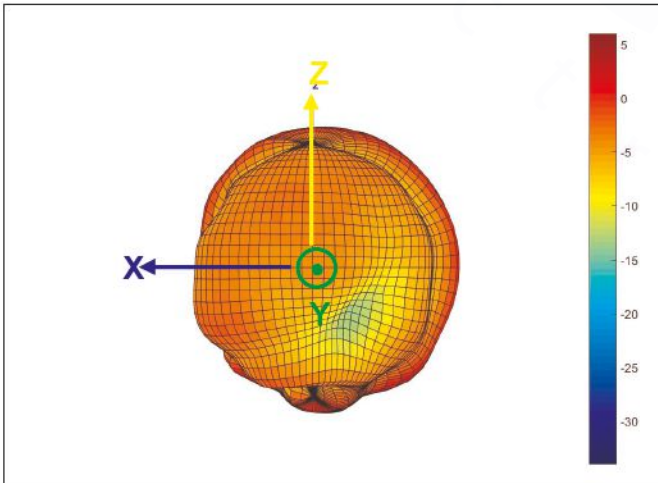
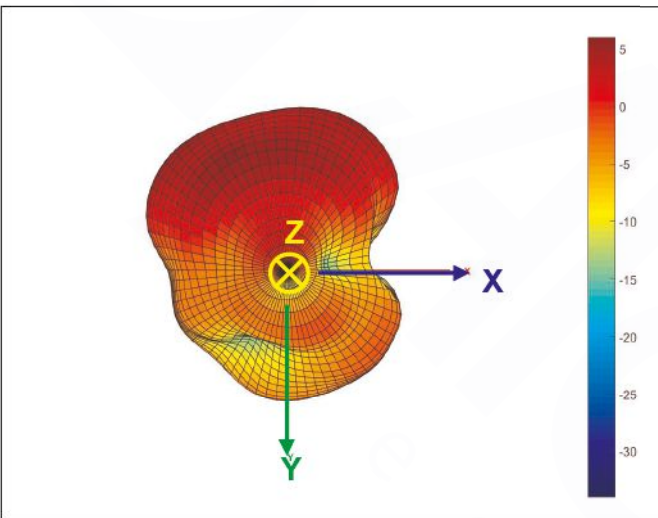
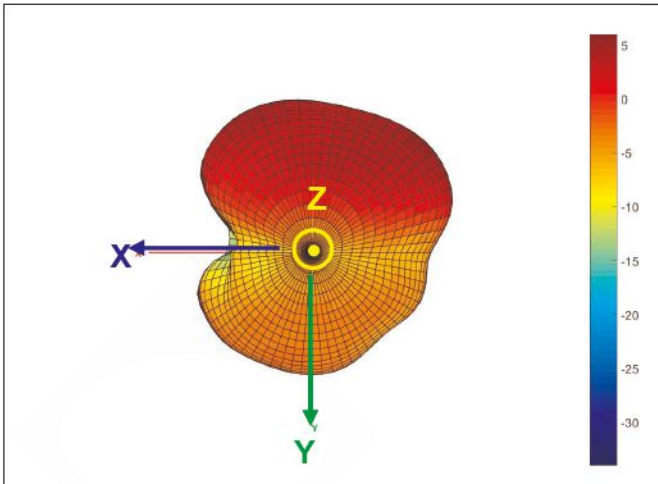

Uniconn
Technologies Corp.
2020-07-07
Document Control Center



詠業科技股份有限公司
Uniconn Technologies Corporation
Website: www.uniconn.com

THIS DRAWINGS AND SPECIFICATIONS ARE THE PROPERTY OF UNICTRON TECHNOLOGIES CORPORATION AND SHALL NOT BE REPRODUCED OR USED AS THE BASIS FOR THE MANUFACTURE OR SALE OF APPARATUS OR DEVICES WITHOUT PERMISSION

Prepared by : Jane

Designed by : Tom

Checked by : Mike

Approved by : Herbert

TITLE : 35.0 x 5.0 x 4.0 (mm) LTE Full-Band Ceramic Chip Antenna (CC35D8) Engineering Specification

DOCUMENT NO.

H2UE3P2D2G0100

REV. G

7-5. 2490~2690MHz Band

3D Radiation Gain Pattern @ 2590 MHz (Unit: dBi)

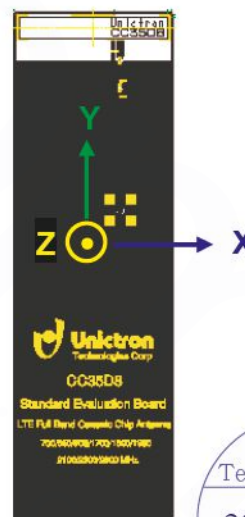
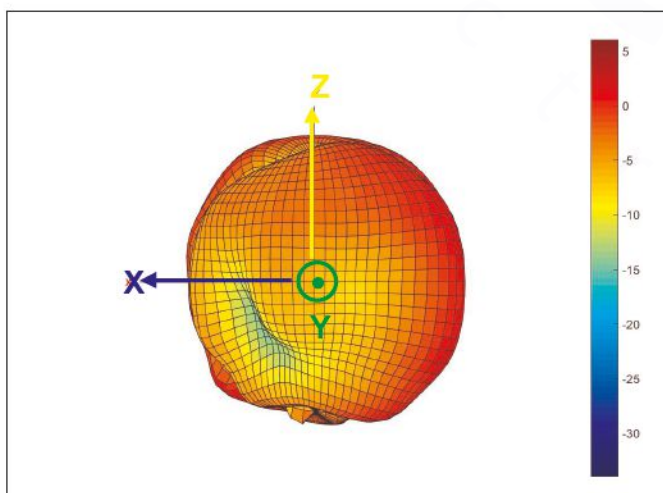
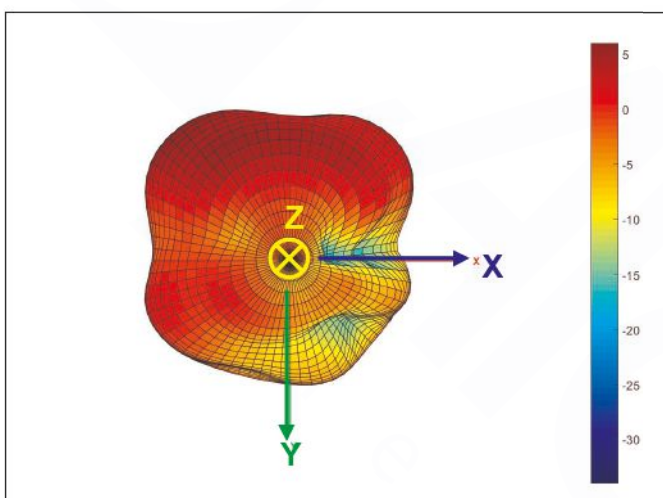
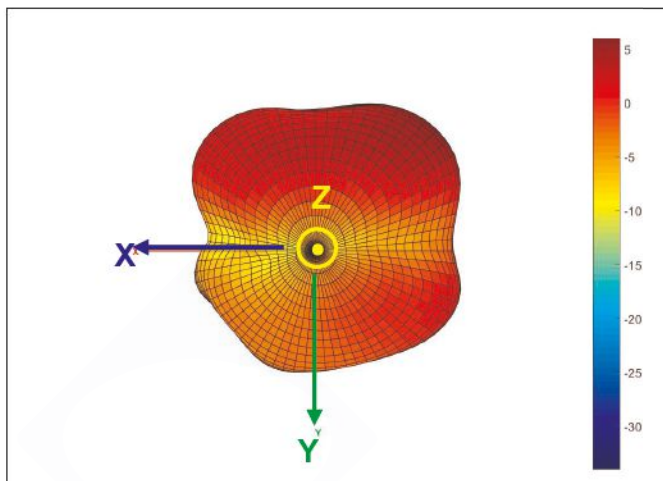

Uniconn Technologies Corp.
2020-07-07
Document Control Center



詠業科技股份有限公司
Uniconn Technologies Corporation
Website: www.uniconn.com

THIS DRAWINGS AND SPECIFICATIONS ARE THE PROPERTY OF UNICONN TECHNOLOGIES CORPORATION AND SHALL NOT BE REPRODUCED OR USED AS THE BASIS FOR THE MANUFACTURE OR SALE OF APPARATUS OR DEVICES WITHOUT PERMISSION

Prepared by : Jane

Designed by : Tom

Checked by : Mike

Approved by : Herbert

TITLE : 35.0 x 5.0 x 4.0 (mm) LTE Full-Band Ceramic Chip Antenna (CC35D8) Engineering Specification

DOCUMENT NO.

H2UE3P2D2G0100

REV. G

8. Frequency tuning and Matching circuit

8-1. Chip antenna tuning scenario :

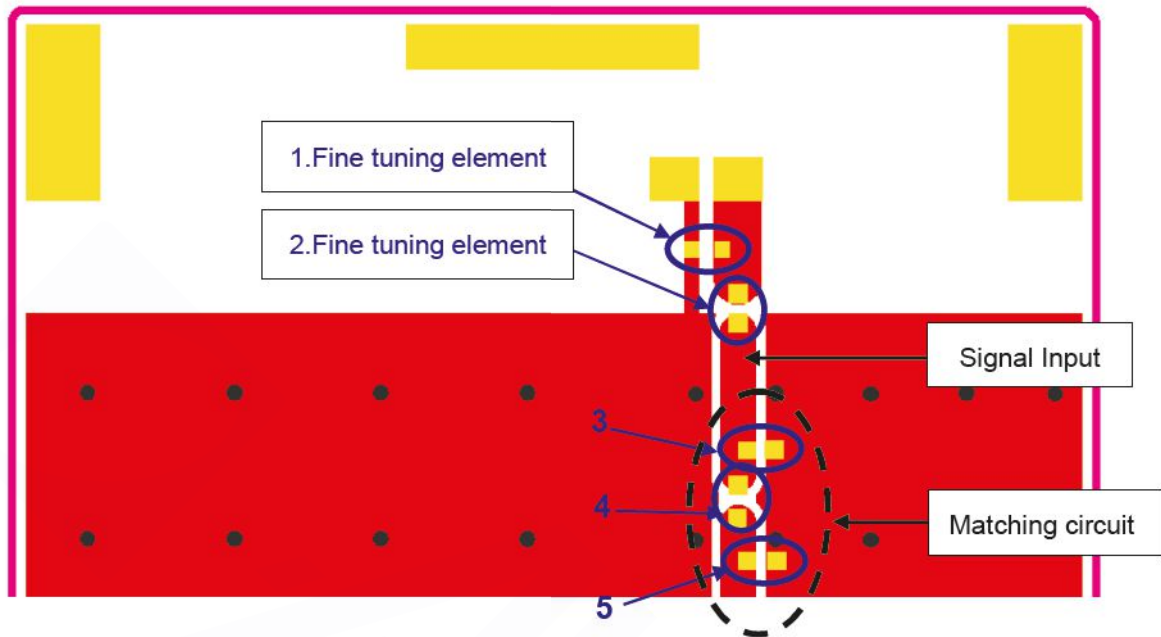

8-2. Matching circuit :

With the following recommended values of matching and tuning components, the covering frequencies will be about 698~960 MHz & 1710~2690 MHz at our standard 118.5 x 37 mm² evaluation board. However, these are typical reference values which may need to be changed when circuit boards or part vendors are different.

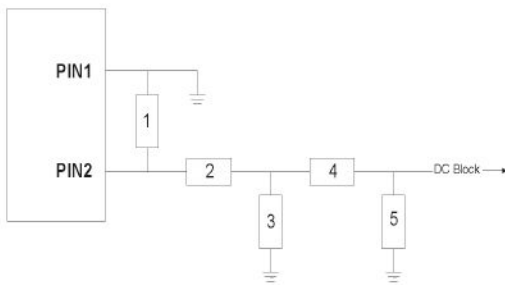

System Matching Circuit Component			
Location	Description	Vendor	Tolerance
1	Fine tuning element	MURATA	±0.1 nH
2	Fine tuning element	MURATA	±0.05 pF
3	N/C	-	-
4	0Ω, (0402)	-	-
5	N/C	-	-



詠業科技股份有限公司
Unictron Technologies Corporation
Website: www.unictron.com

THIS DRAWINGS AND SPECIFICATIONS ARE THE PROPERTY OF UNICTRON TECHNOLOGIES CORPORATION AND SHALL NOT BE REPRODUCED OR USED AS THE BASIS FOR THE MANUFACTURE OR SALE OF APPARATUS OR DEVICES WITHOUT PERMISSION

Prepared by : Jane

Designed by : Tom

Checked by : Mike

Approved by : Herbert

TITLE : 35.0 x 5.0 x 4.0 (mm) LTE Full-Band Ceramic Chip Antenna (CC35D8) Engineering Specification

DOCUMENT NO.

H2UE3P2D2G0100

REV. G

9. Soldering Conditions

Typical Soldering Profile for Lead-free Process

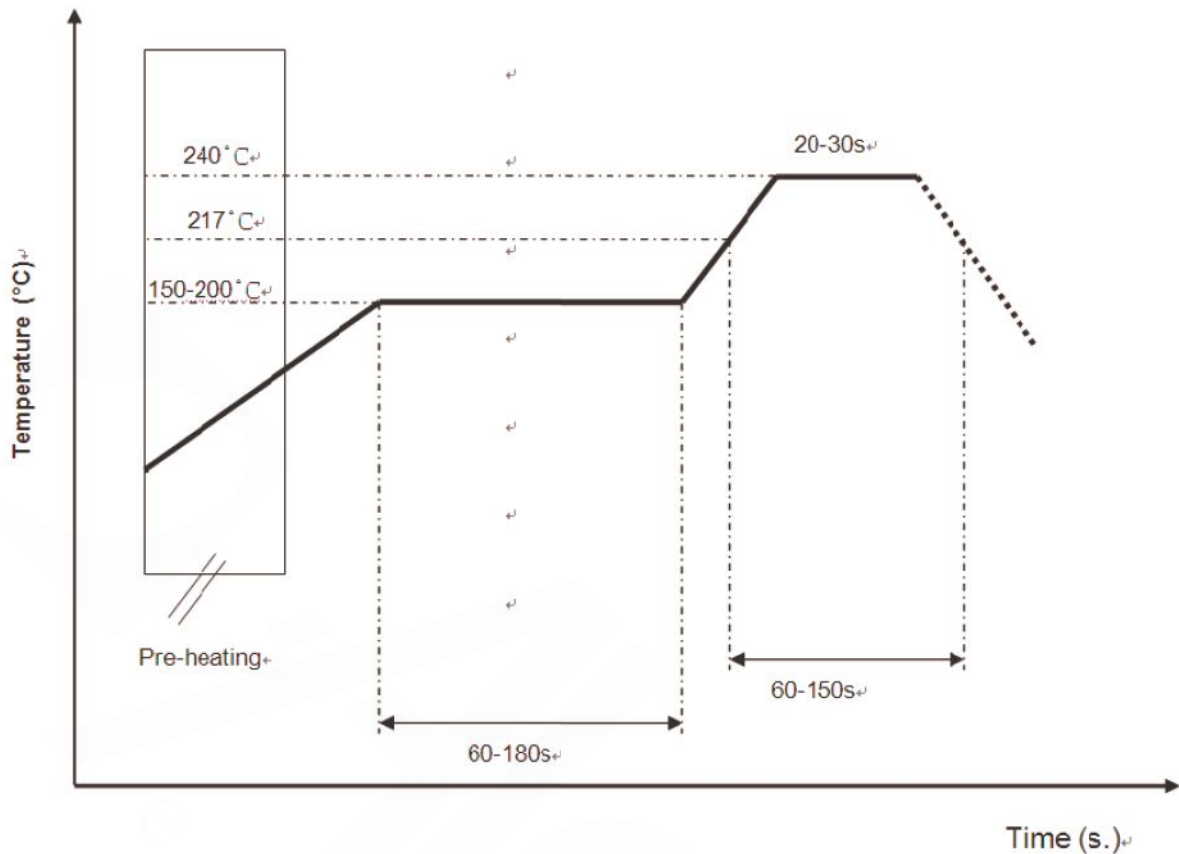

*Recommended solder paste alloy: SAC305 (Sn96.5 /Ag3 /Cu0.5) Lead Free solder paste

10. Reminders for users of Unictron's CC35D8 ceramic chip antennas

- 10-1. This chip antenna is made of ceramic materials which is relatively more rigid and brittle compared to circuit board materials. Furthermore, the length of this antenna is quite long. Bending of circuit board at the locations where chip antenna is mounted may cause the cracking of solder joints or antenna itself.
- 10-2. Punching/cutting of the break-off tab of PCB panel may cause severe bending of the circuit board which may result in cracking of solder joints or chip antenna itself. Therefore break-off tab shall be located away from the installation site of chip antenna.
- 10-3. Be cautious when ultrasonic welding process needs to be used near the locations where chip antennas are installed. Strong ultrasonic vibration may cause the cracking of chip antenna solder joints.



詠業科技股份有限公司
Unictron Technologies Corporation
Website: www.unictron.com

THIS DRAWINGS AND SPECIFICATIONS ARE THE PROPERTY OF UNICTRON TECHNOLOGIES CORPORATION AND SHALL NOT BE REPRODUCED OR USED AS THE BASIS FOR THE MANUFACTURE OR SALE OF APPARATUS OR DEVICES WITHOUT PERMISSION

Prepared by : Jane

Designed by : Tom

Checked by : Mike

Approved by : Herbert

TITLE : 35.0 x 5.0 x 4.0 (mm) LTE Full-Band Ceramic Chip Antenna (CC35D8) Engineering Specification

DOCUMENT NO.

H2UE3P2D2G0100

REV. G

11. Packing(Unit: mm)

a. Reel Dimensions

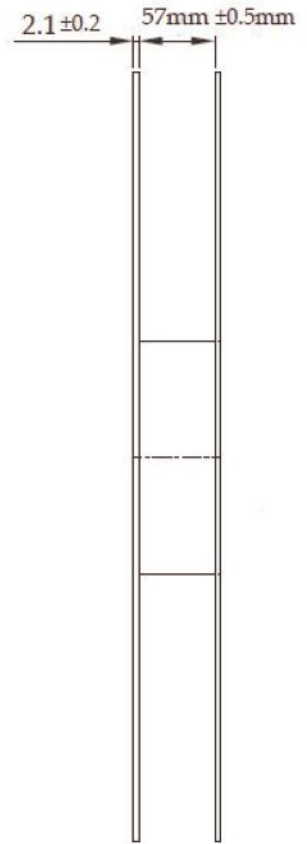
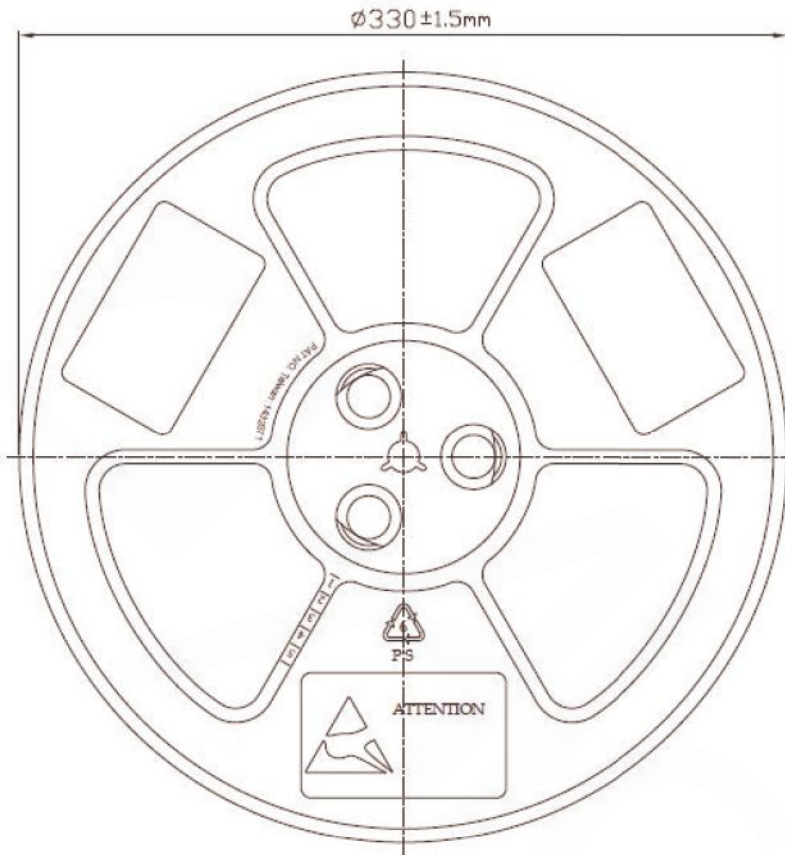

b. Tape Drawing

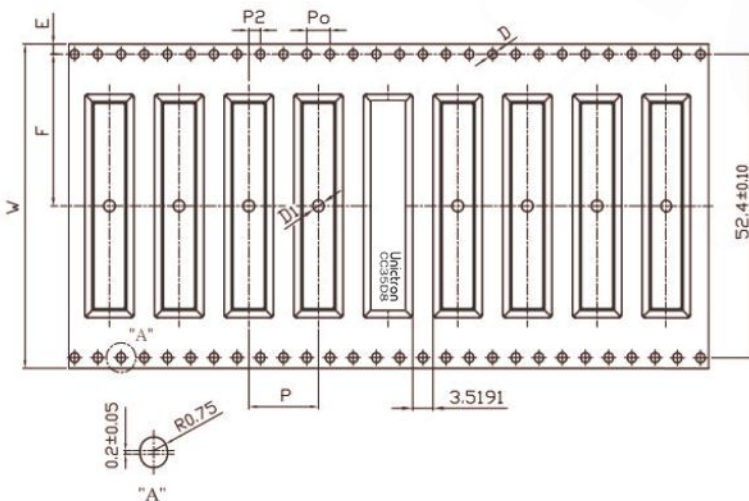

c. Tape Dimensions

Feature	Specifications	Tolerances
W	56.00	± 0.30
P	12.00	± 0.10
E	1.75	± 0.10
F	26.20	± 0.15
P2	2.00	± 0.15
D	1.50	+0.10 -0.00
D1	2.00	± 0.10
Po	4.00	± 0.10
10Po	40.00	± 0.20



詠業科技股份有限公司
Unictron Technologies Corporation
Website: www.unictron.com

THIS DRAWINGS AND SPECIFICATIONS ARE THE PROPERTY OF UNICTRON TECHNOLOGIES CORPORATION AND SHALL NOT BE REPRODUCED OR USED AS THE BASIS FOR THE MANUFACTURE OR SALE OF APPARATUS OR DEVICES WITHOUT PERMISSION

Prepared by : Jane

Designed by : Tom

Checked by : Mike

Approved by : Herbert

TITLE : 35.0 x 5.0 x 4.0 (mm) LTE Full-Band Ceramic Chip Antenna (CC35D8) Engineering Specification

DOCUMENT NO.

H2UE3P2D2G0100

REV. G

- d. (1) Weight: 1 pcs / 2.3g typ
1 Reel / 3Kg typ
- (2) Quantity/Reel: 1000 pcs/Reel
- (3) Plastic tape: Clear Non Anti-static Polystyrene



- e. (1) Weight: 2 Reel / 1 carton 6.6Kg typ
- (2) 2 Reel / 2000 pcs in one carton
- (3) Carton Dimensions – 340*350*200 mm

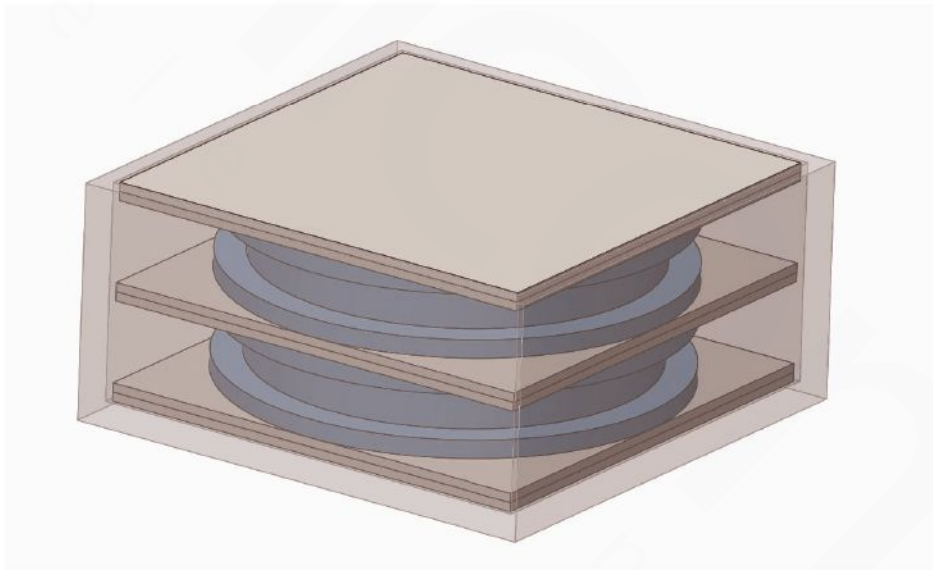

詠業科技股份有限公司
Unictron Technologies Corporation
Website: www.unictron.com

THIS DRAWINGS AND SPECIFICATIONS ARE THE PROPERTY OF UNICTRON TECHNOLOGIES CORPORATION AND SHALL NOT BE REPRODUCED OR USED AS THE BASIS FOR THE MANUFACTURE OR SALE OF APPARATUS OR DEVICES WITHOUT PERMISSION

Prepared by : Jane

Designed by : Tom

Checked by : Mike

Approved by : Herbert

TITLE : 35.0 x 5.0 x 4.0 (mm) LTE Full-Band Ceramic Chip Antenna (CC35D8) Engineering Specification

DOCUMENT NO.

H2UE3P2D2G0100

REV. G

12. Operating & Storage Conditions

12-1. Operating

- (1) Maximum Input Power: 5 W
- (2) Operating Temperature: -40°C to 85°C
- (3) Relative Humidity: 10% to 70%

12-2. Storage (sealed)

- (1) Storage Temperature: -5°C to 40°C
- (2) Relative Humidity: 20% to 70%
- (3) Shelf Life: 1 year

12-3. Storage (unsealed)

Meet the criteria of J-STD-033 MSL2a

12-4. Storage (After mounted on customer's PCB with SMT process)

- (1) Storage Temperature: -40°C to 85°C
- (2) Relative Humidity: 10% to 70%

13. Notice

(1) Installation Guide:

Please refer to Unictron's application note "General guidelines for the installation of Unictron's chip antennas" for further information.

(2) All specifications are subject to change without notice.



詠業科技股份有限公司
Unictron Technologies Corporation
Website: www.unictron.com

THIS DRAWINGS AND SPECIFICATIONS ARE THE PROPERTY OF UNICTRON TECHNOLOGIES CORPORATION AND SHALL NOT BE REPRODUCED OR USED AS THE BASIS FOR THE MANUFACTURE OR SALE OF APPARATUS OR DEVICES WITHOUT PERMISSION

Prepared by : Jane

Designed by : Tom

Checked by : Mike

Approved by : Herbert

TITLE : 35.0 x 5.0 x 4.0 (mm) LTE Full-Band Ceramic Chip Antenna (CC35D8) Engineering Specification

DOCUMENT NO.

H2UE3P2D2G0100

REV. G

14. Reliability Test

Test Items	Test Conditions	Result
1. Solderability	*Solder Temperature : 250 ± 5°C *Test time: 2 +/- 0.5 sec *With solder paste	Pass
2. Temperature cycling	-40°C/ 30min~90°C /30min Total <u>10</u> cycles * Specimens are kept at standard measurement environment for more than 24 hours before testing.	Pass
3. Damp heat	*Humidity:90~95% *Temperature: 85°C *Test time : 240 hours * Specimens are kept at standard measurement environment for more than 24 hours before testing..	Pass
4. Adhesive strength of terminal electrodes	* Resistance to bending of printed-circuit test board(110x40x1.6mm) * Applied force: 5Kgf ; * Duration : 10±1sec	Pass
5. High temperature exposure	*Temperature : 90°C *Test duration : 240 hours * Specimens are kept at standard measurement environment for more than 24 hours before testing.	Pass
6. Low temperature exposure	*Temperature : -40°C *Test duration : 240 hours * Specimens are kept at standard measurement environment for more than 24 hours before testing.	Pass



詠業科技股份有限公司
Unictron Technologies Corporation
Website:www.unictron.com

THIS DRAWINGS AND SPECIFICATIONS ARE THE PROPERTY OF UNICTRON TECHNOLOGIES CORPORATION AND SHALL NOT BE REPRODUCED OR USED AS THE BASIS FOR THE MANUFACTURE OR SALE OF APPARATUS OR DEVICES WITHOUT PERMISSION

Prepared by : Jane

Designed by : Tom

Checked by : Mike

Approved by : Herbert