



TAOGLAS®



Datasheet

Synergy 8 in 1 Antenna

Part No:
MA1508.AK.001

Description:

Synergy 8-in-1 Combination antenna with 1*Active GNSS, 4*5G/4G MIMO and 3*Wi-Fi MIMO

Features:

- 4 x 5G/4G MIMO Antenna
- 3 x Wi-Fi 2.4GHz/5.8GHz MIMO Antenna
- 1 x GPS/GLONASS/BeiDou Antenna Front End GNSS SAW Filter
- IP67 Rated Waterproof Enclosure
- High Efficiency/Peak Gain Outdoor Antenna
- Dimensions: Ø161*55mm
- Cable: 300mm RG-174 with 4700mm TGC-200
- Connectors: SMA(M) for GNSS and 5G/4G / RP-SMA(M) for Wi-Fi
- RoHS & REACH Compliant

1. Introduction	3
2. Specifications	4
3. Active Antenna Characteristics	10
4. Antenna Characteristics	16
5. Radiation Patterns	24
6. Mechanical Drawing	71
7. Installation Guidelines	72
8. Packaging	74
Changelog	75

Taoglas makes no warranties based on the accuracy or completeness of the contents of this document and reserves the right to make changes to specifications and product descriptions at any time without notice. Taoglas reserves all rights to this document and the information contained herein. Reproduction, use or disclosure to third parties without express permission is strictly prohibited.



1. Introduction



The Taoglas Synergy MA1508 is a 8-in-1 next-generation permanent mount antenna for vehicle roof applications. It has a fully IP67 rated waterproof robust PC enclosure and base. The 9 antennas inside support 5G/4G, GPS/GLONASS/BeiDou, Wi-Fi (2.4GHz/5GHz). This outstanding patent-pending antenna delivers powerful MIMO antenna technology for 5G/4G, Wi-Fi 2.4/5.8GHz 802.11n and the emerging 802.11ac, and an optimized GPS/GLONASS/BeiDou patch antenna for location. The 5G/4G antennas also include backward compatibility to work at most worldwide 2G and 3G bands.

Typical Applications:

- Next Generation OEM Automotive Connectivity
- Multimedia, Navigation and Telematics Systems
- V2V, V2X and Fleet Management Applications
- Real-time HD Video Streaming
- First Net Responder Routers

The MA1508 is ideal for applications that require highly sophisticated antennas for real-time streaming applications that demand high-speed video uplink and downlink into the cabin of the vehicle. These challenges are resolved by the highly efficient, high gain MIMO antennas, with high isolation, all of which is necessary to achieve the required signal to noise ratio and throughput.

The MA1508 can also be customized for your particular wireless application and frequency band, subject to NRE and MOQ. There are 8x 300mm RG-174 cables, terminating in SMA(M) connectors for 5G/4G MIMO 4X4, and RP SMA(M) for Wi-Fi MIMO 3X3. There is a 300mm RG-174 cable for GNSS terminating in an SMA(M) connector.

All cable lengths and connector types are customizable. The Synergy MA1508 can be supplied with low loss TGC-200 cable extensions for longer cable runs. Contact your regional Taoglas customer services team for details and support.

2. Specifications

GNSS Frequency Bands Covered							
GPS/QZSS	L1 1575.42MHz	L2 1227.6MHz	L5 1176.45MHz	L6 1278.75MHz			
	■	□	□	□			
GLONASS	L5R 1176.45MHz	L3PT 1201.5MHz	L2PT 1246MHz	L1CR 1575.42MHz	L1PT 1602MHz		
	□	□	□	■	■		
Galileo	E5a 1176.45MHz	E5b 1201.5MHz	E4 1215MHz	E3 1256MHz	E6 1278.75MHz	E2 1561MHz	L1 1575.42MHz
	□	□	□	□	□	■	■
BeiDou	B1 1561MHz	B2 1207.14MHz	B3 1268.52MHz				
	■	□	□				
Compass	E5B(B2)/ E6(B3) 1268.56MHz	E2(B1) 1561MHz					
	□	■					
SBAS	Omnistar 1542.5MHz	WAAS/EGN OS 1575.42MHz					
	□	■					

GNSS Electrical			
Frequency (MHz)	1561	1575.42	1602
VSWR (max.)	2.5	2.5	2.5
Passive Antenna Efficiency (%) (Without cable loss)	40.02	48.39	44.29
Passive Antenna Gain at Zenith (dBic) (Without cable loss)	3.75	4.44	4.54
Axial Ratio (dB)	20	11	15
Polarization	RHCP		
Impedance	50Ω		
Cable	RG-174		
Connector	SMA(M)		

LNA and Filter Electrical Properties			
Frequency (MHz)	1561	1575.42	1602
VSWR (max.)	2.0:1	2.0:1	2.0:1
Gain@1.8V (dBic)	28.8 dB	28.8 dB	28 dB
Gain@3.0V (dBic)	29 dB	29 dB	28.3 dB
Gain@5.5V (dBic)	29.6 dB	29.4 dB	28.7 dB
Noise@1.8V (dB)	2.8 dB	2.3 dB	2.8 dB
Noise@3.0V (dB)	2.8 dB	2.2 dB	2.8 dB
Noise@5.5V (dB)	2.9 dB	2.3 dB	2.8 dB
Power consumption@1.8V (mA)	8.7 mA		
Power consumption@3.0V (mA)	9.0 mA		
Power consumption@5.5V (mA)	11 mA		
Total Specification (Through Antenna, SAW Filter and LNA)			
Frequency (MHz)	1561	1575.42	1602
Gain@3V (dBic)	31.7 ± 3	32.4 ± 3	32.4 ± 3
Output Impedance	50Ω		

5G/4G Antenna											
Frequency (MHz)		5G NR Band 71	LTE700	GSM 850/900	5G NR Band	DCS	PCS	UMTS1	LTE2600	5G NR Band 77, 78, 79	LTE5200/Wi-Fi 5800
		617 ~698	698 ~824	824 ~960	1427 ~1518	1710 ~1880	1850 ~1990	1920 ~2170	2300 ~2690	3300 ~3800	5150 ~5925
Efficiency (%)											
MIMO 1	5m	30.79	30.39	34.96	39.48	46.48	32.68	32.15	43.45	49.25	49.39
MIMO 2	5m	18.62	31.96	30.24	43.80	42.07	37.06	38.94	44.95	31.36	44.49
MIMO 3	5m	30.07	30.40	32.11	47.07	42.70	34.09	33.14	41.63	49.49	20.60
MIMO 4	5m	21.05	30.90	32.56	38.32	42.80	39.73	38.88	43.70	29.88	48.09
Average Gain (dB)											
MIMO 1	5m	-5.12	-5.17	-4.56	-4.04	-3.33	-4.86	-4.93	-3.62	-3.08	-3.06
MIMO 2	5m	-7.30	-4.95	-5.19	-3.59	-3.76	-4.31	-4.10	-3.47	-5.04	-3.52
MIMO 3	5m	-5.22	-5.17	-4.93	-3.27	-3.70	-4.67	-4.80	-3.81	-3.06	-6.86
MIMO 4	5m	-6.77	-5.10	-4.87	-4.17	-3.69	-4.01	-4.10	-3.59	-5.25	-3.18
Peak Gain (dBi)											
MIMO 1	5m	-0.08	1.04	2.03	2.94	4.55	2.93	3.20	4.96	5.82	5.90
MIMO 2	5m	-0.58	0.49	1.42	3.76	3.31	2.32	3.75	4.84	3.77	5.89
MIMO 3	5m	0.25	1.44	1.63	3.47	3.77	2.45	3.00	5.06	5.99	5.57
MIMO 4	5m	-0.20	1.13	2.93	2.52	3.61	2.79	3.97	4.76	2.91	6.28
Impedance		50 Ω									
Polarization		Linear									
Radiation Pattern		Omni									
Max. input power		2W									

Wi-Fi MIMO			
Frequency (MHz)		2400~2500	5150~5850
Efficiency (%)			
MIMO 1	5m	33.16	42.72
MIMO 2	5m	47.59	47.92
MIMO 3	5m	35.95	35.76
Average Gain (dB)			
MIMO 1	5m	-4.79	-3.69
MIMO 2	5m	-3.22	-3.19
MIMO 3	5m	-4.44	-4.47
Peak Gain (dBi)			
MIMO 1	5m	2.11	5.78
MIMO 2	5m	3.12	7.03
MIMO 3	5m	2.16	5.30
Impedance		50 Ω	
Polarization		Linear	
Radiation Pattern		Omni	
Max. input power		2W	

Mechanical	
Height	57.47mm
Planner Dimension	Ø160mm
Casing	PC
Cable	0.3m RG-174 with 4.7m TGC-200 for 5G/4G – Fully Customizable 0.3m RG-174 with 4.7m TGC-200 for Wi-Fi – Fully Customizable 0.3m RG174 with 4.7m TGC-200 for GNSS – Fully Customizable
Connector	5G/4G: SMA-Plug – Fully Customizable Wi-Fi: RP-SMA-Plug – Fully Customizable GNSS: SMA-Plug – Fully Customizable
Thread	18.23mm
Thread Diameter	M22
Sealant	Rubber Stopper and O-Ring
Weight	2.5Kg
Environmental	
Ingress Protection	IP67
Temperature Range	-40°C to 85°C
Humidity	Non-condensing 65°C 95% RH
Cable Pull	RG-174 4 Kg

5G/4G Bands			
Band Number	5GNR / FR1 / LTE / LTE-Advanced / WCDMA / HSPA / HSPA+ / TD-SCDMA		
	Uplink	Downlink	Covered
1	UL: 1920 to 1980	DL: 2110 to 2170	✓
2	UL: 1850 to 1910	DL: 1930 to 1990	✓
3	UL: 1710 to 1785	DL: 1805 to 1880	✓
4	UL: 1710 to 1755	DL: 2110 to 2155	✓
5	UL: 824 to 849	DL: 869 to 894	✓
7	UL: 2500 to 2570	DL: 2620 to 2690	✓
8	UL: 880 to 915	DL: 925 to 960	✓
9	UL: 1749.9 to 1784.9	DL: 1844.9 to 1879.9	✓
11	UL: 1427.9 to 1447.9	DL: 1475.9 to 1495.9	✓
12	UL: 699 to 716	DL: 729 to 746	✓
13	UL: 777 to 787	DL: 746 to 756	✓
14	UL: 788 to 798	DL: 758 to 768	✓
17	UL: 704 to 716	DL: 734 to 746 (LTE only)	✓
18	UL: 815 to 830	DL: 860 to 875 (LTE only)	✓
19	UL: 830 to 845	DL: 875 to 890	✓
20	UL: 832 to 862	DL: 791 to 821	✓
21	UL: 1447.9 to 1462.9	DL: 1495.9 to 1510.9	✓
22	UL: 3410 to 3490	DL: 3510 to 3590	✓
23	UL: 2000 to 2020	DL: 2180 to 2200 (LTE only)	✓
24	UL: 1625.5 to 1660.5	DL: 1525 to 1559 (LTE only)	✓
25	UL: 1850 to 1915	DL: 1930 to 1995	✓
26	UL: 814 to 849	DL: 859 to 894	✓
27	UL: 807 to 824	DL: 852 to 869 (LTE only)	✓
28	UL: 703 to 748	DL: 758 to 803 (LTE only)	✓
29	UL: -	DL: 717 to 728 (LTE only)	✓
30	UL: 2305 to 2315	DL: 2350 to 2360 (LTE only)	✓
31	UL: 452.5 to 457.5	DL: 462.5 to 467.5 (LTE only)	✗
32	UL: -	DL: 1452 - 1496	✓
35		1850 to 1910	✓
38		2570 to 2620	✓
39		1880 to 1920	✓
40		2300 to 2400	✓
41		2496 to 2690	✓
42		3400 to 3600	✓
43		3600 to 3800	✓
48		3550 to 3700	✓
66	UL: 1710-1780	DL: 2110-2200	✓
71		617 to 698	✓
74/75/76		1427 to 1518	✓
78		3300 to 3800	✓
79		4400 to 5000	✓

* Covered Bands represent greater than 20% efficiency

3. Active Antenna Characteristics

3.1 Block Diagram (Active antenna)

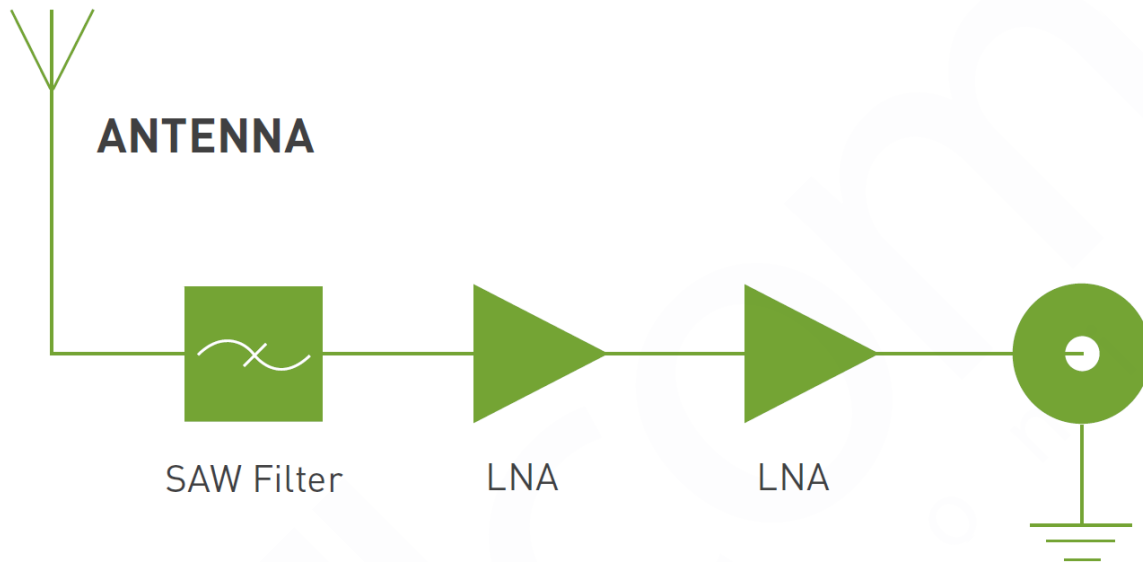

3.2 Passive Antenna Return Loss

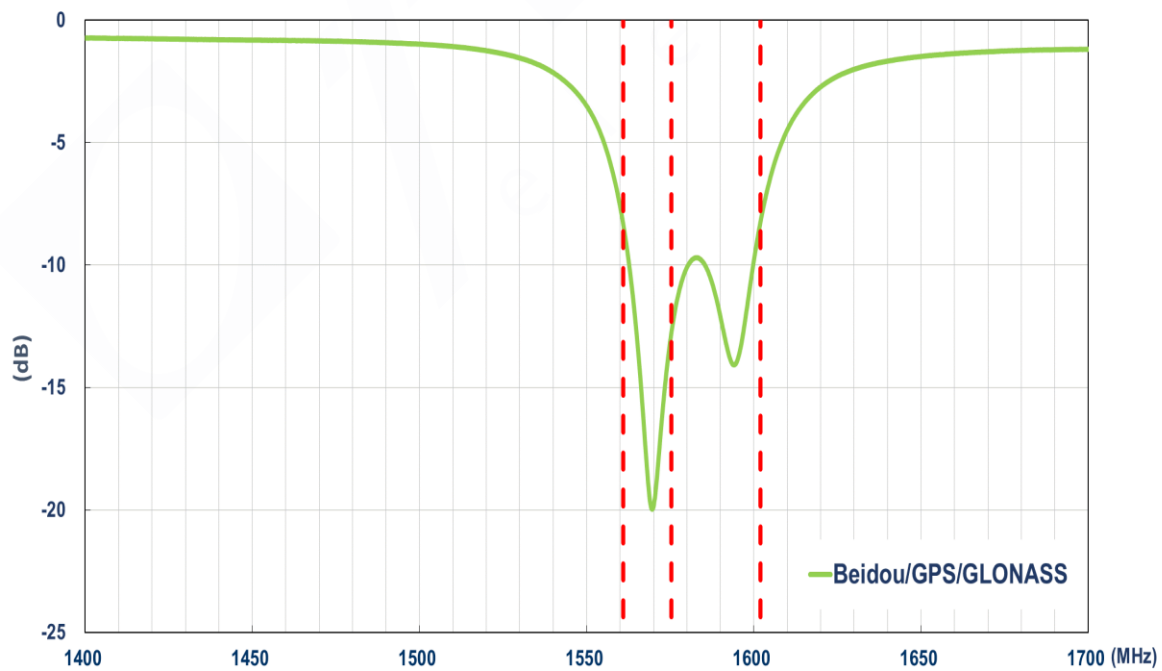

3.3 Passive Antenna Efficiency

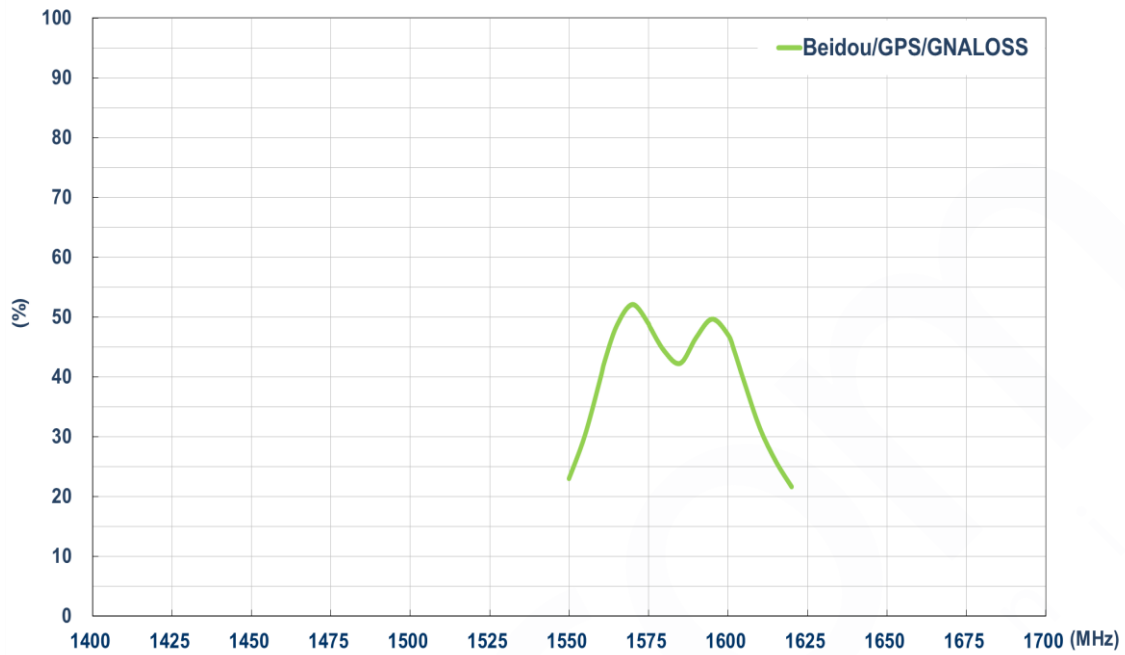

3.4 Passive Antenna Average Gain

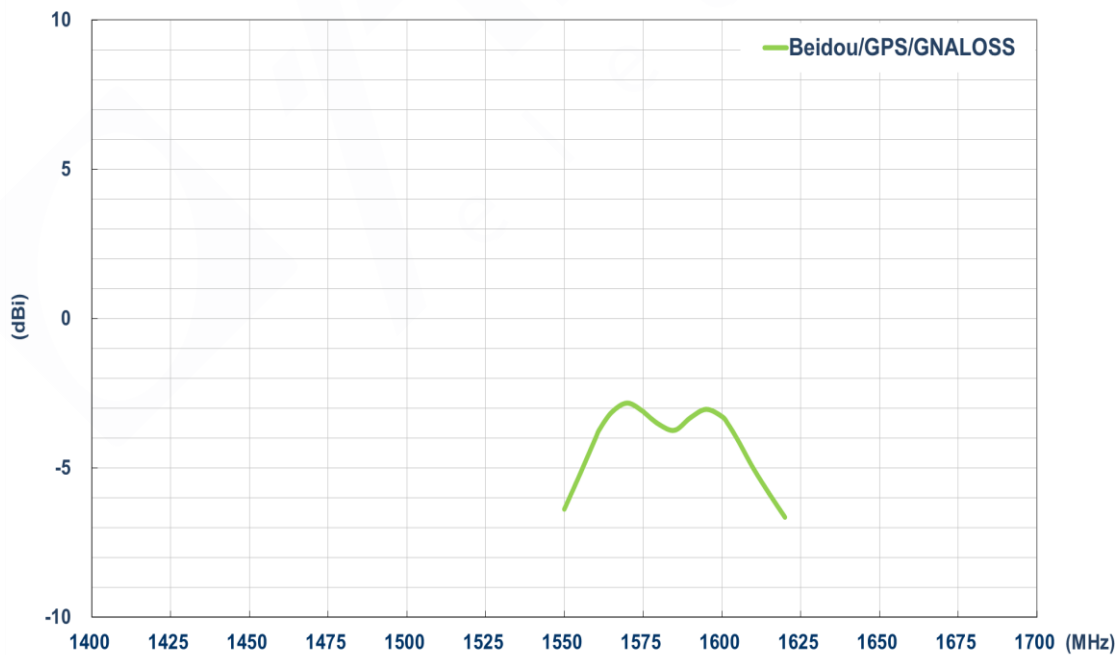

3.5 Passive Antenna Peak Gain

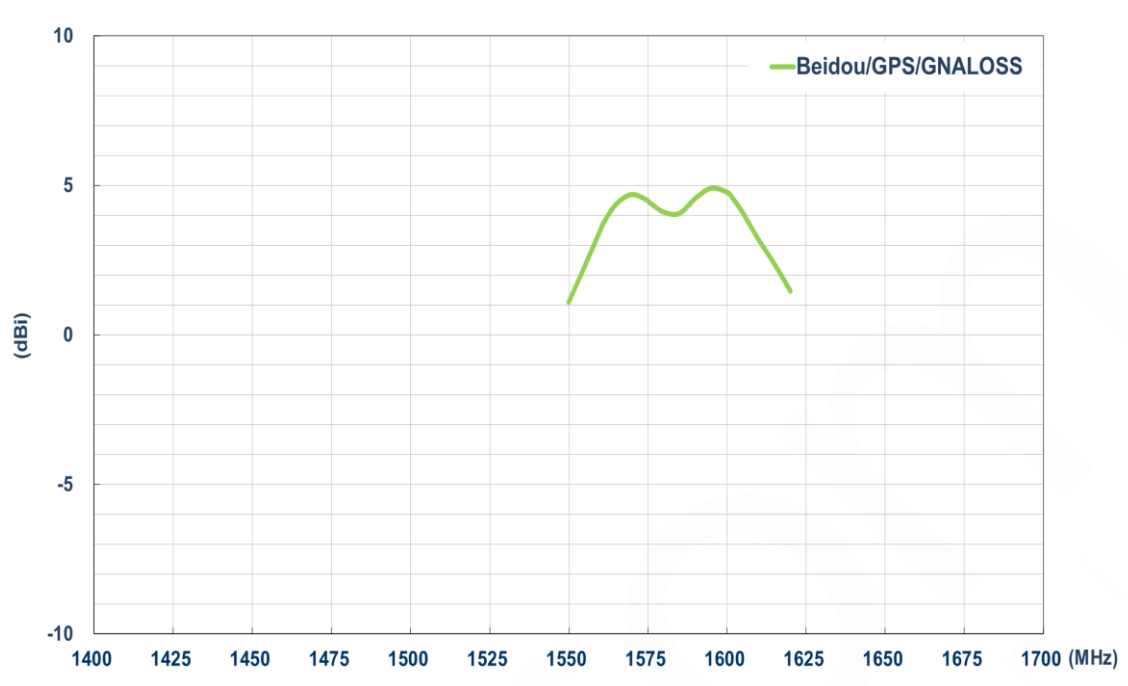

3.6 Passive Antenna Axial Ratio (Zenith is at 0°)

XZ-plane

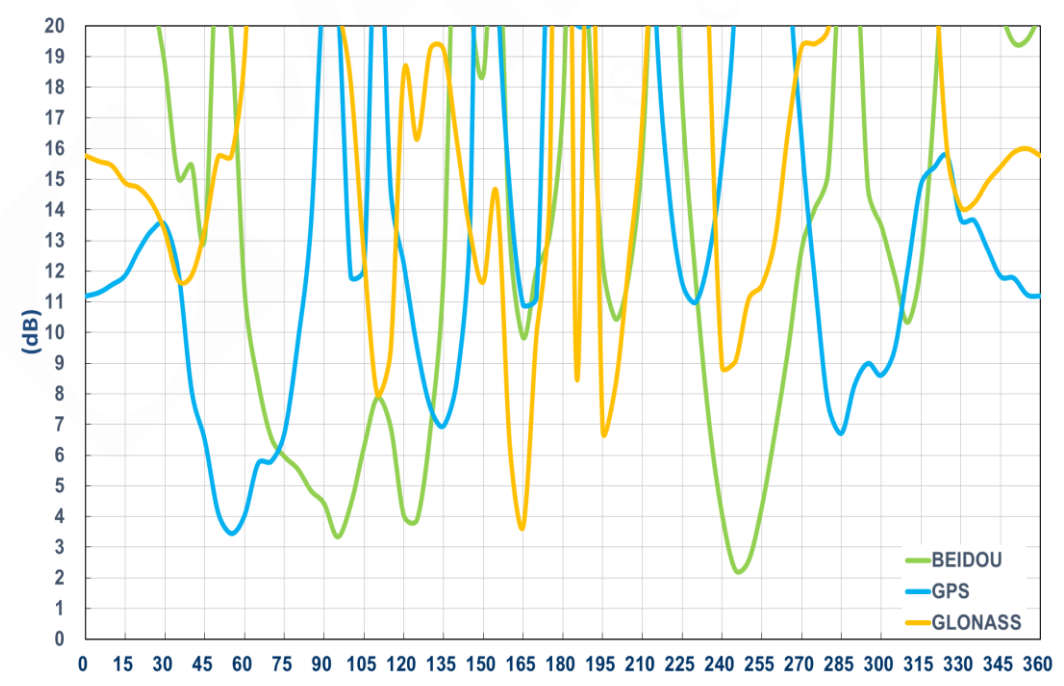

YZ-plane

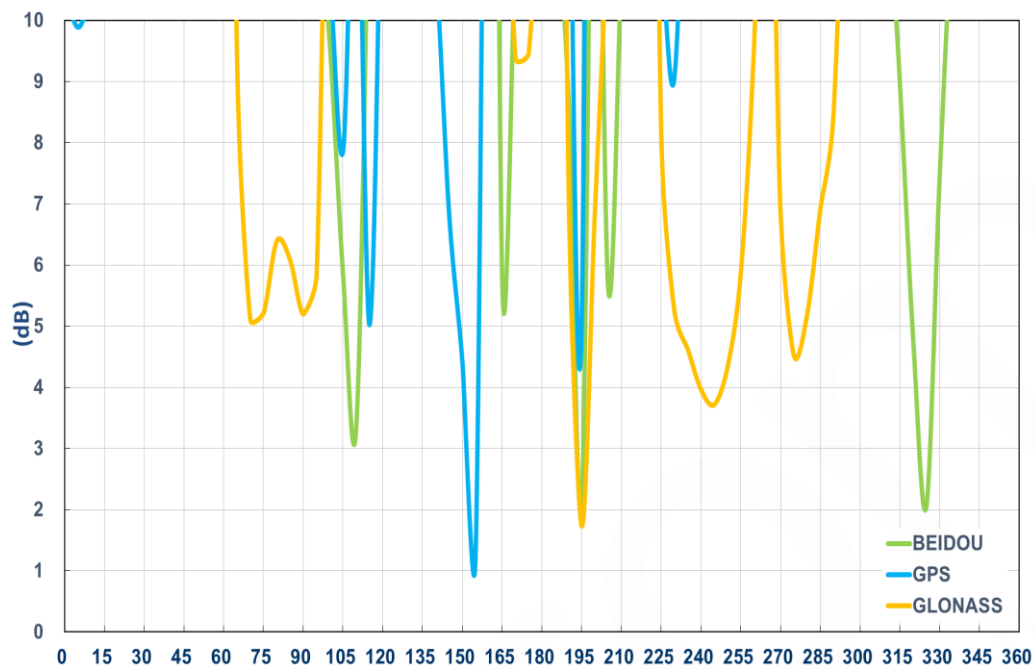

3.7 Active measurements

LNA Gain @ 3.0V

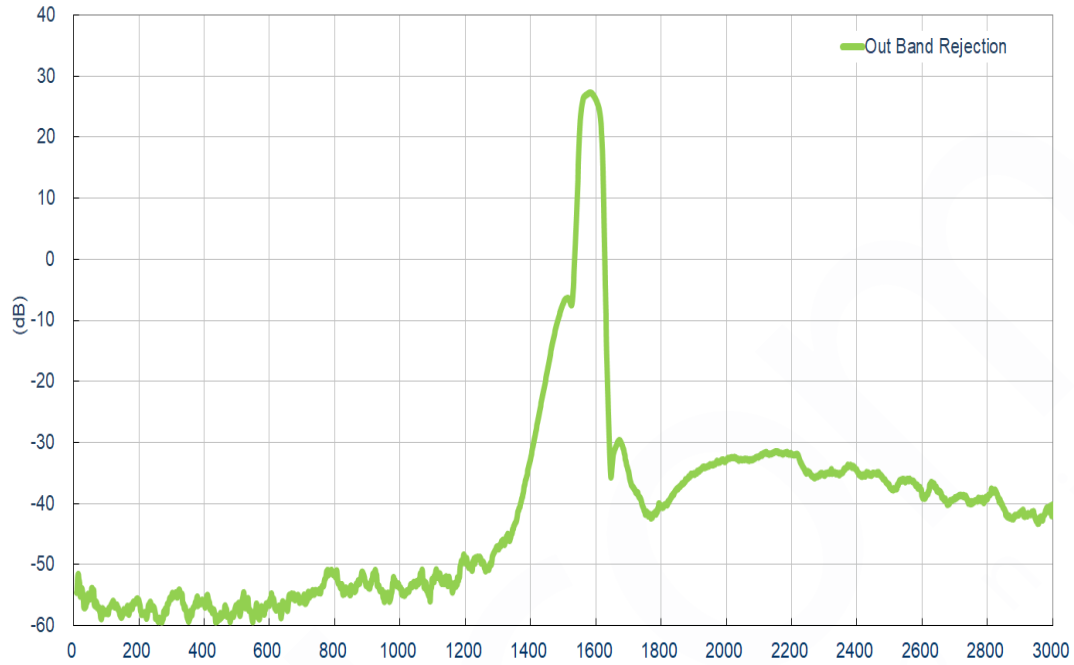

Noise Figure @ 3.0V

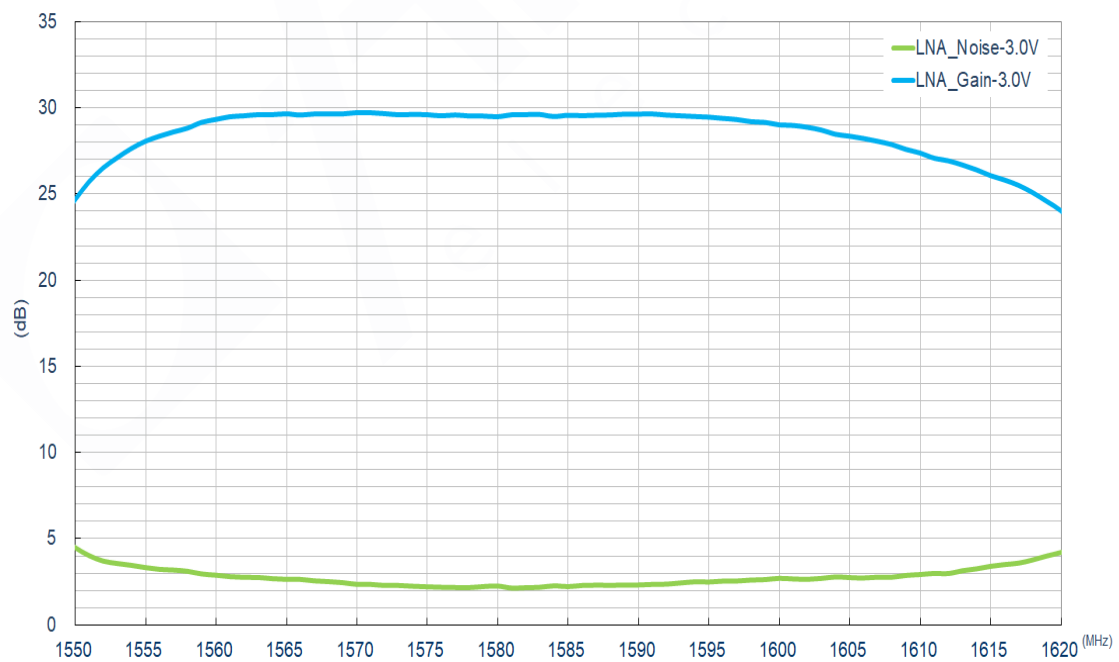

3.8 Passive Antenna Radiation Patterns

1575.42MHz

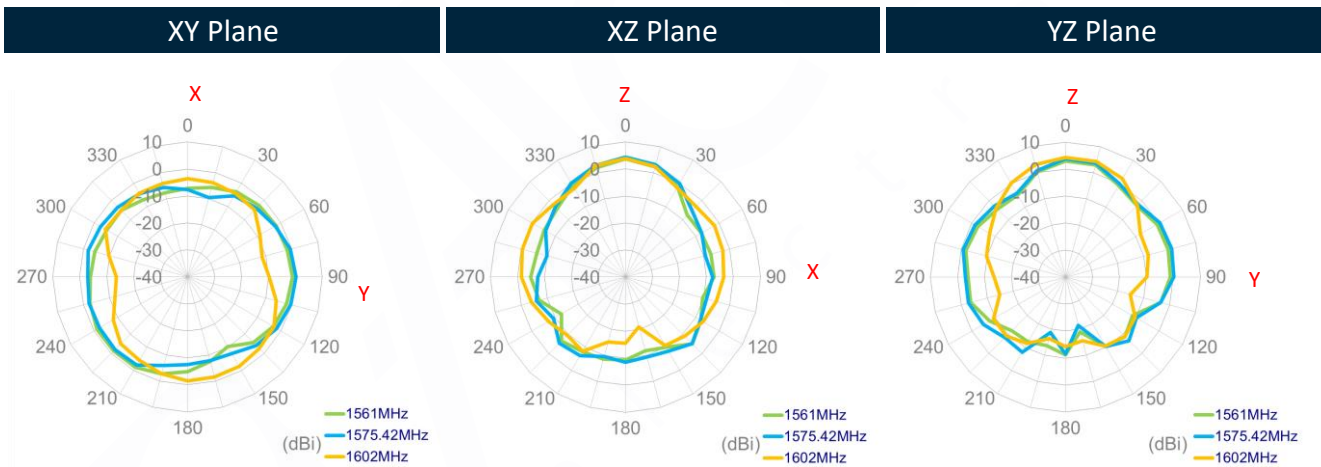
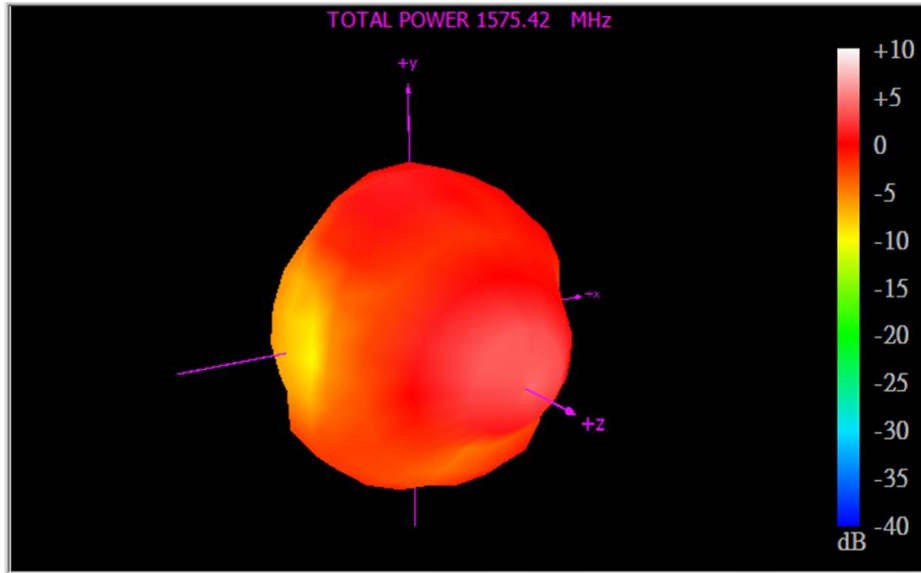

4. Antenna Characteristics

4.1 Return Loss

5G/4G MIMO

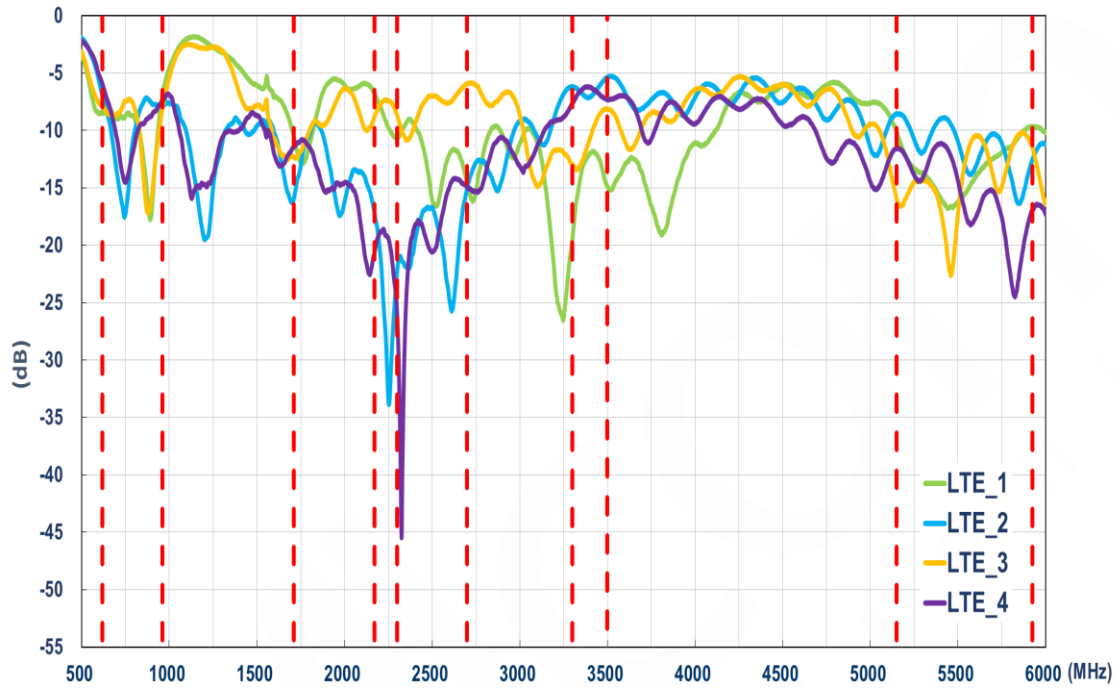

Wi-Fi MIMO

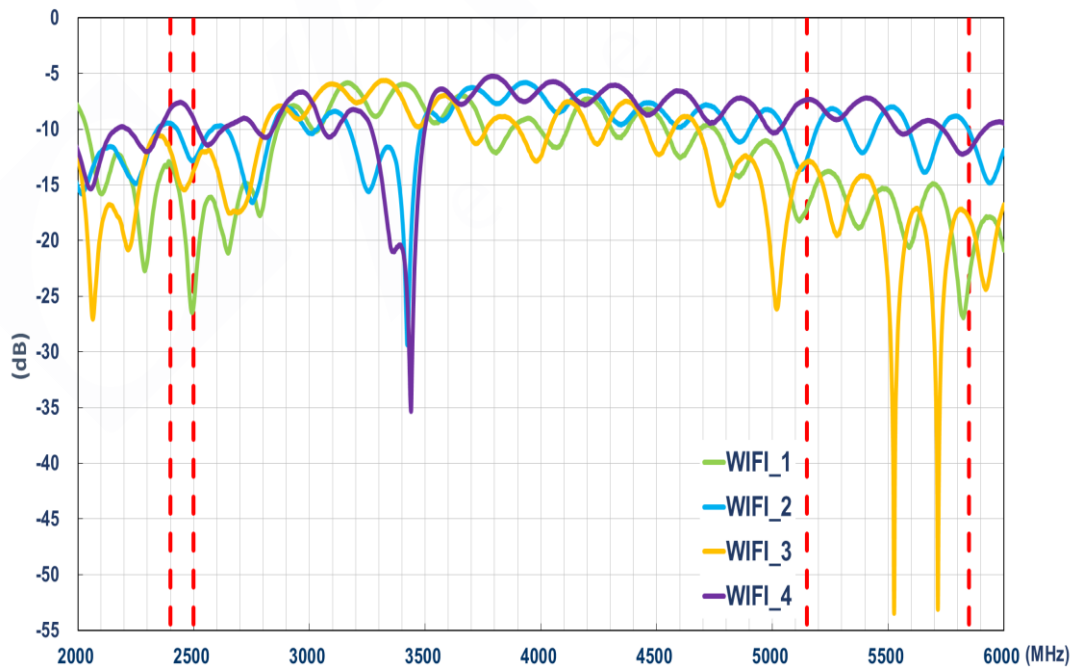

4.2 Isolation

5G/4G 1

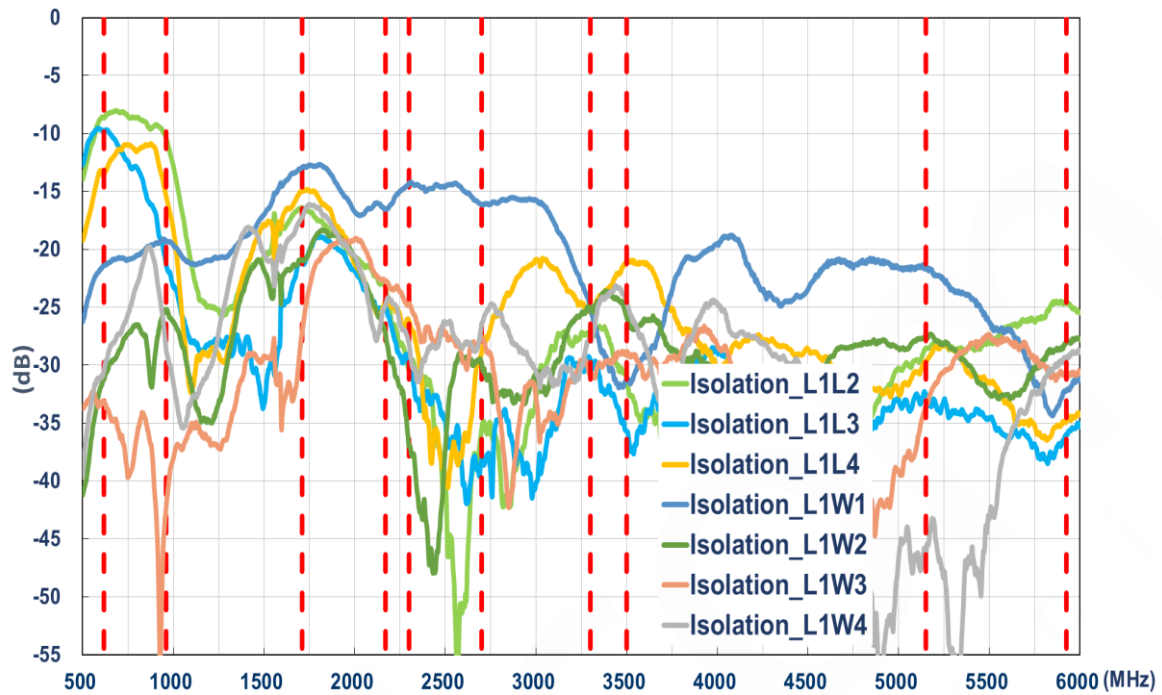

5G/4G 2

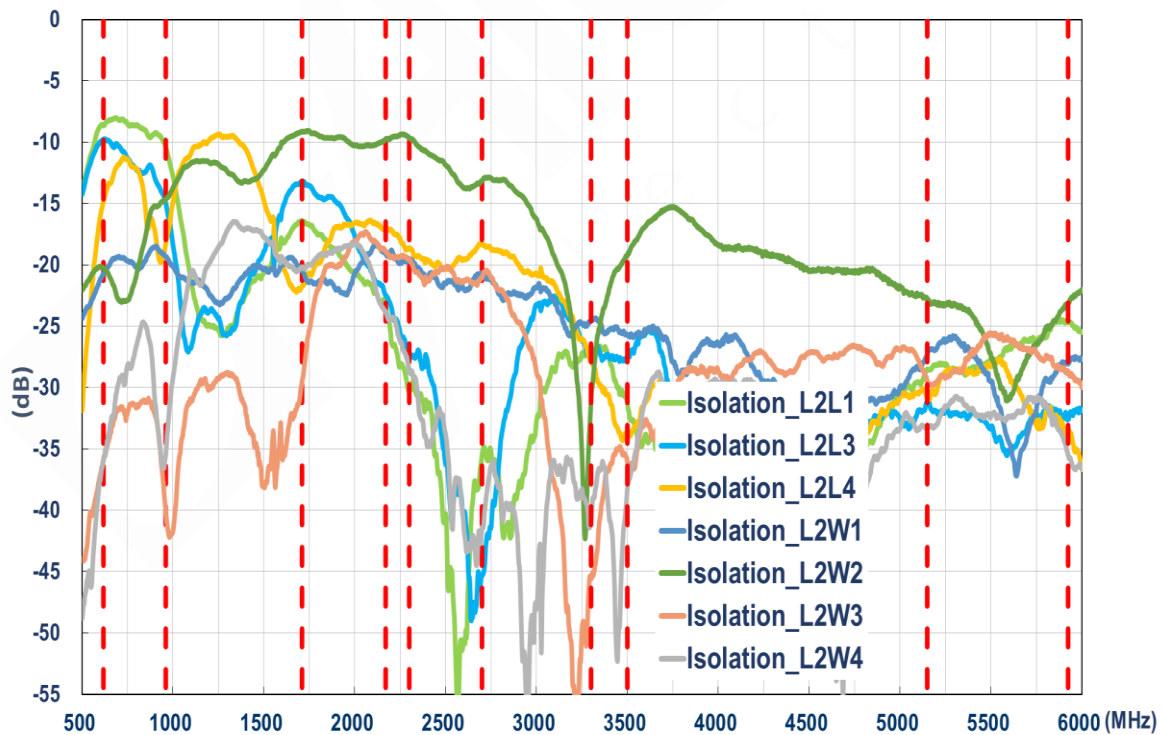

5G/4G 3

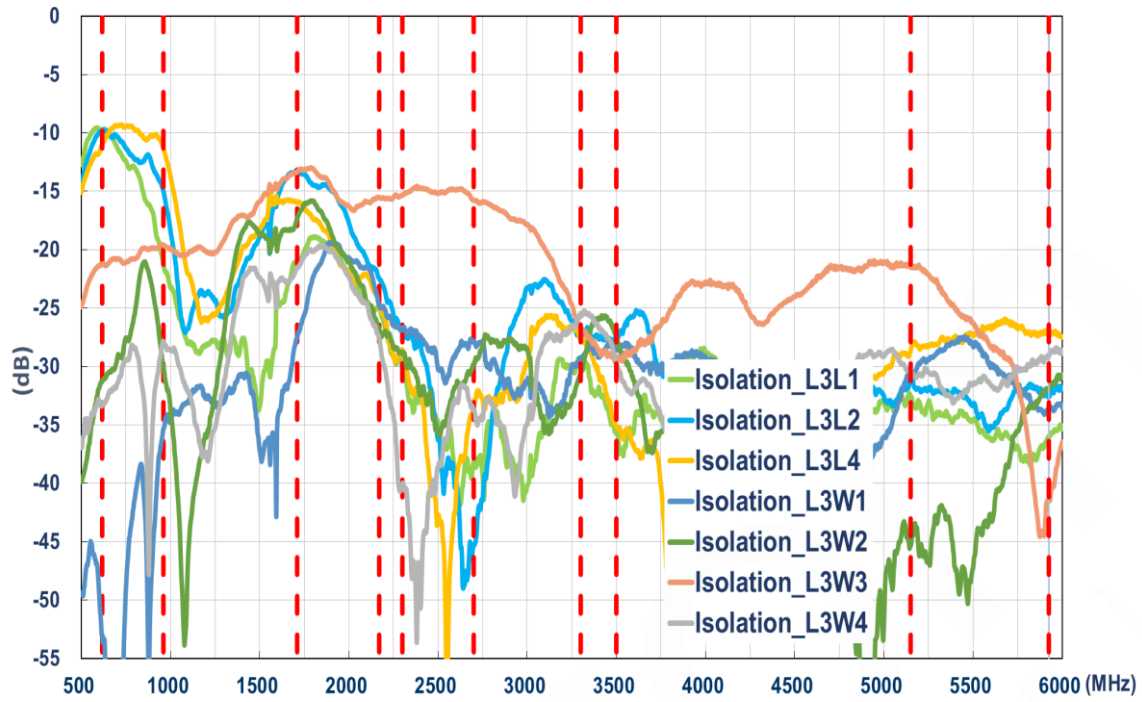

5G/4G 4

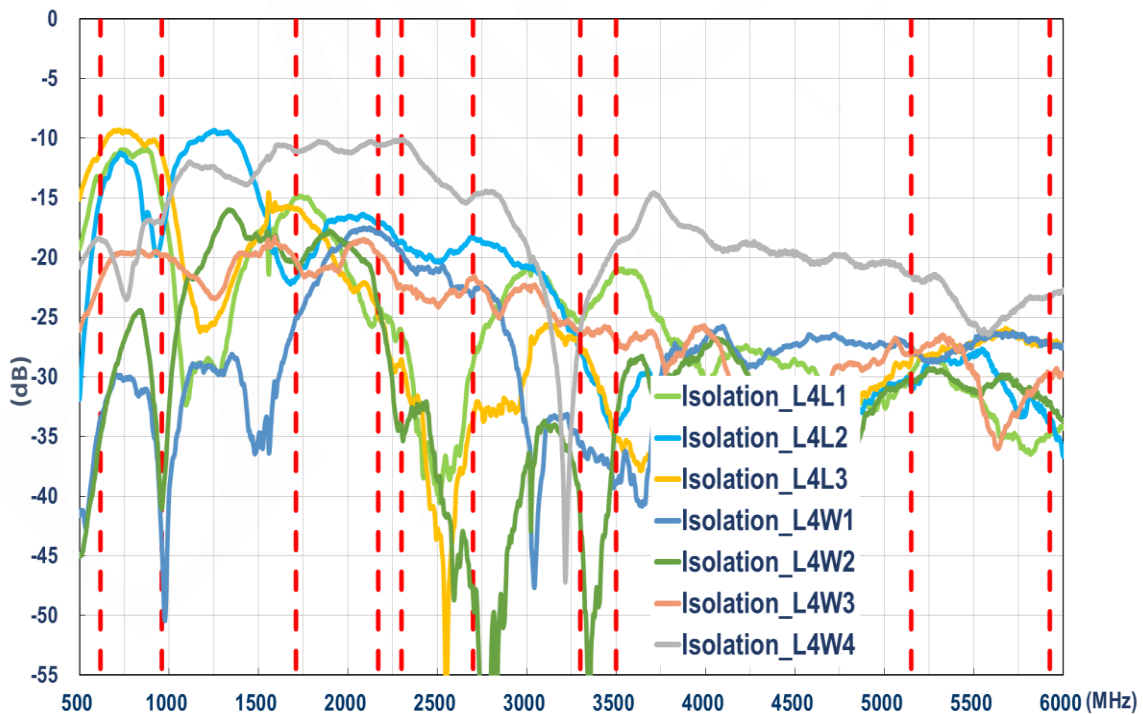

Wi-Fi 1

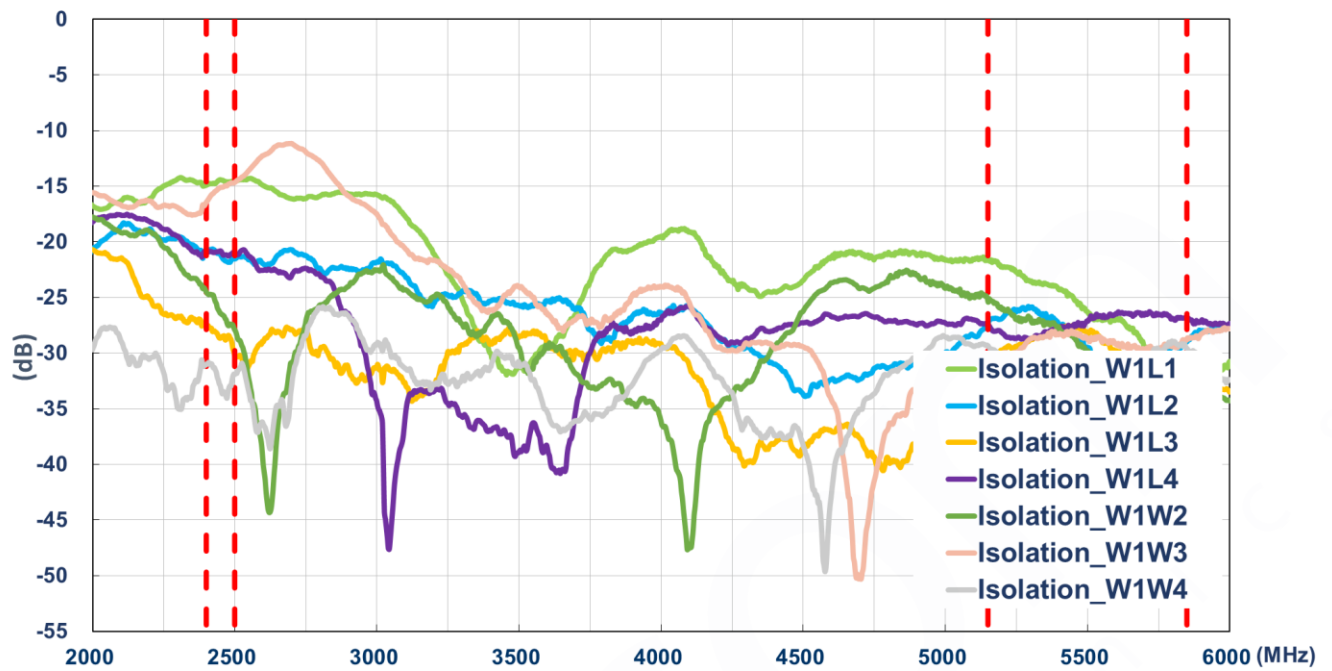

Wi-Fi 2

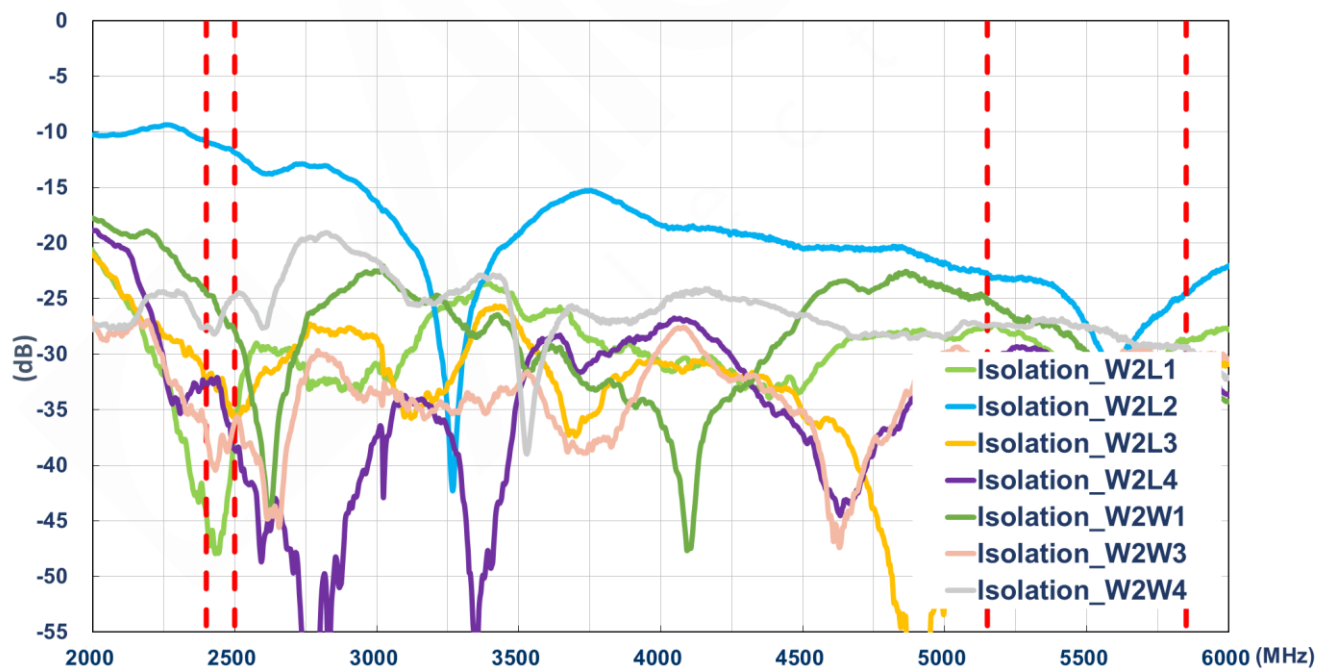

Wi-Fi 3

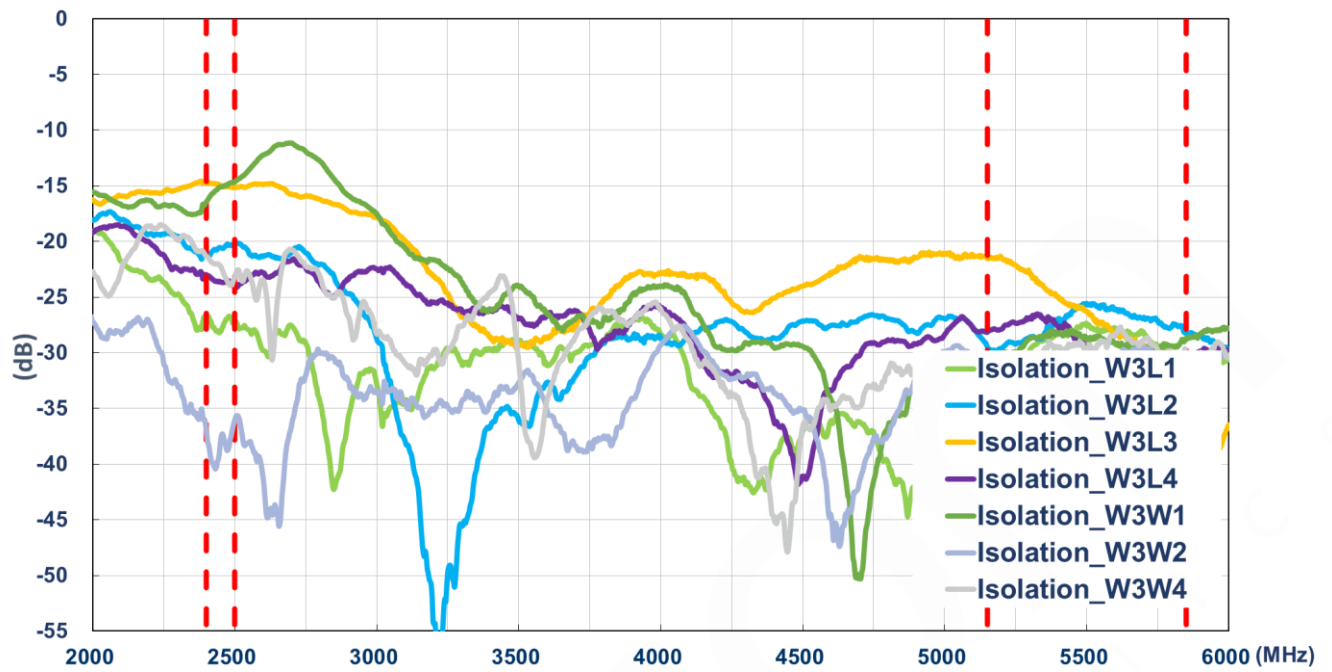

4.3 Efficiency

5G/4G MIMO

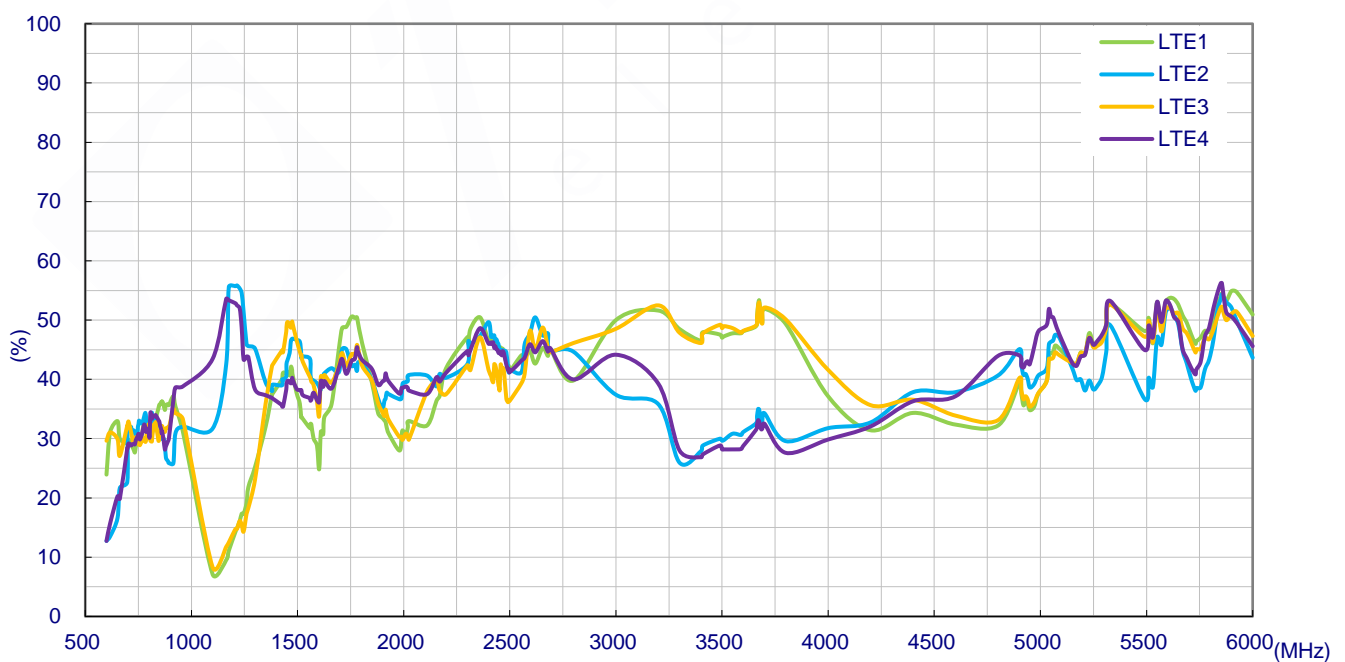

Wi-Fi MIMO

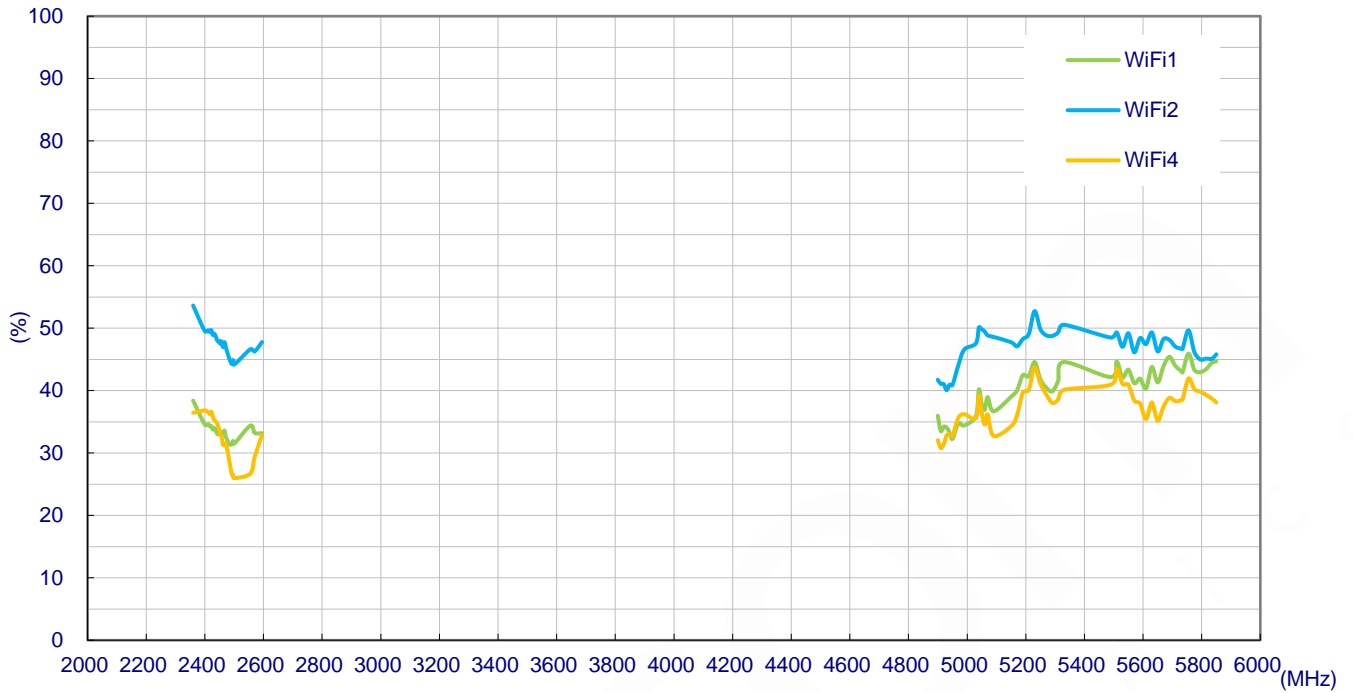

4.4 Average Gain

5G/4G MIMO

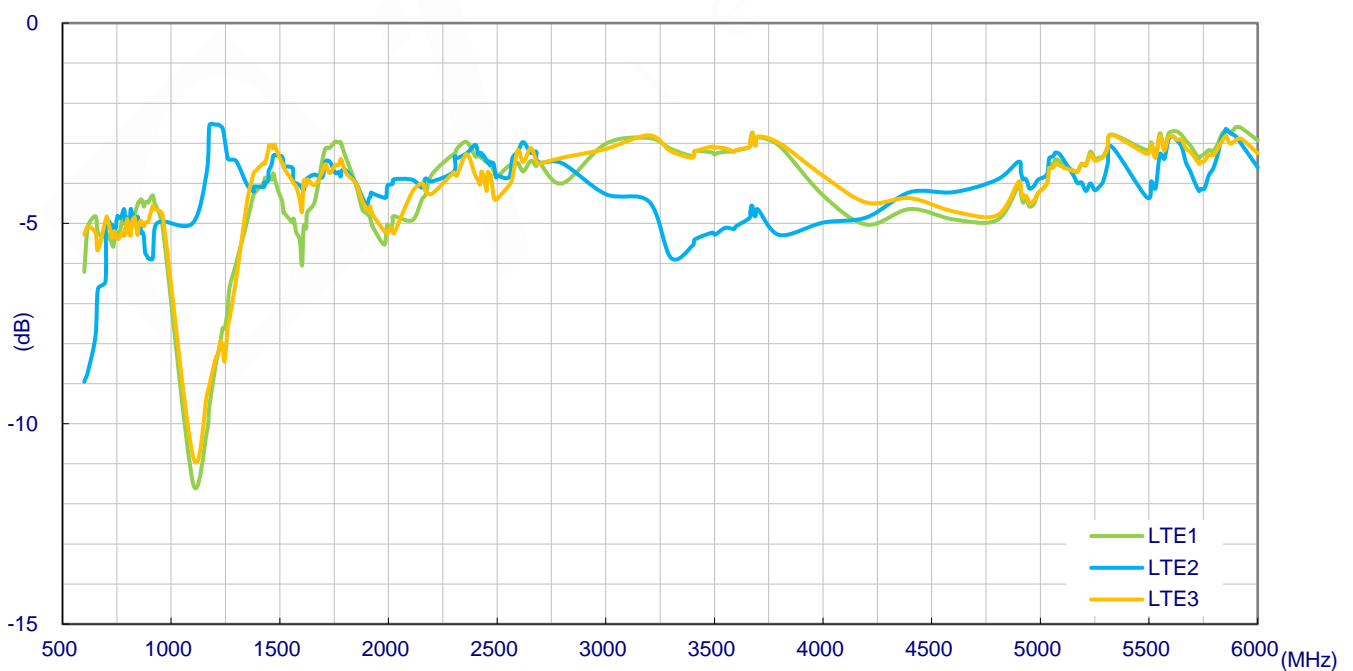

Wi-Fi MIMO

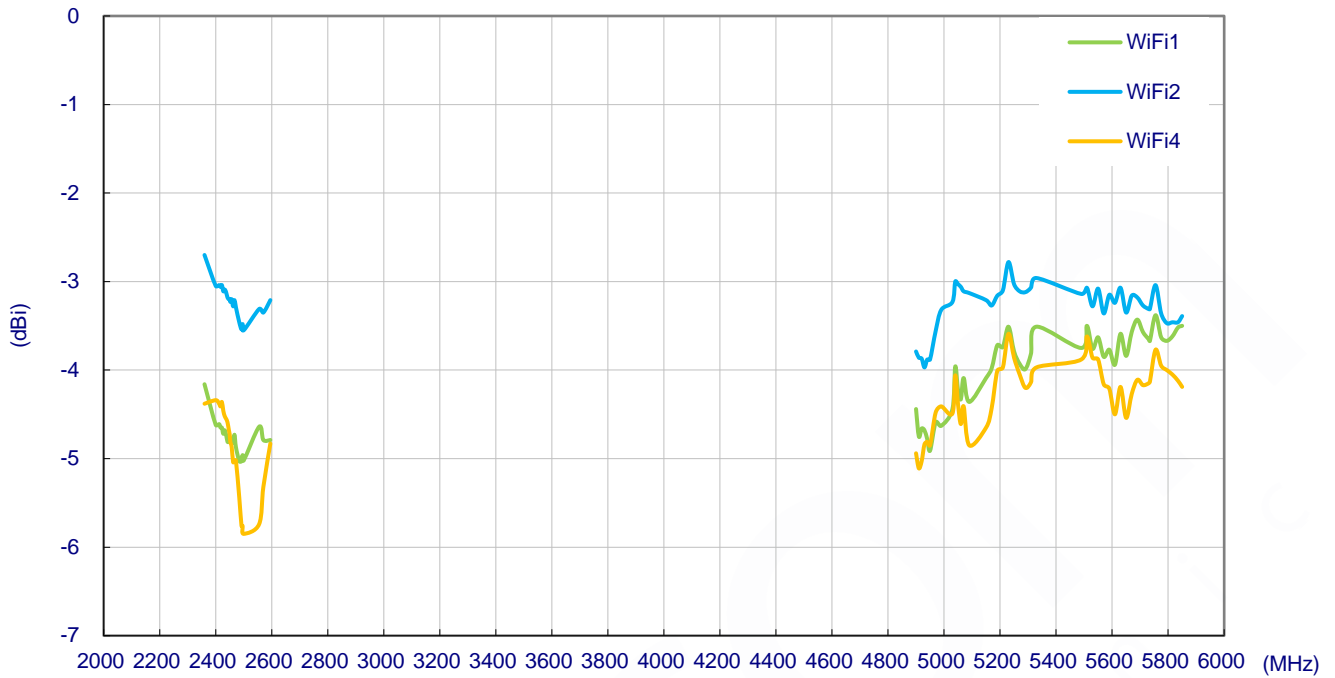

4.5 Peak Gain

5G/4G MIMO

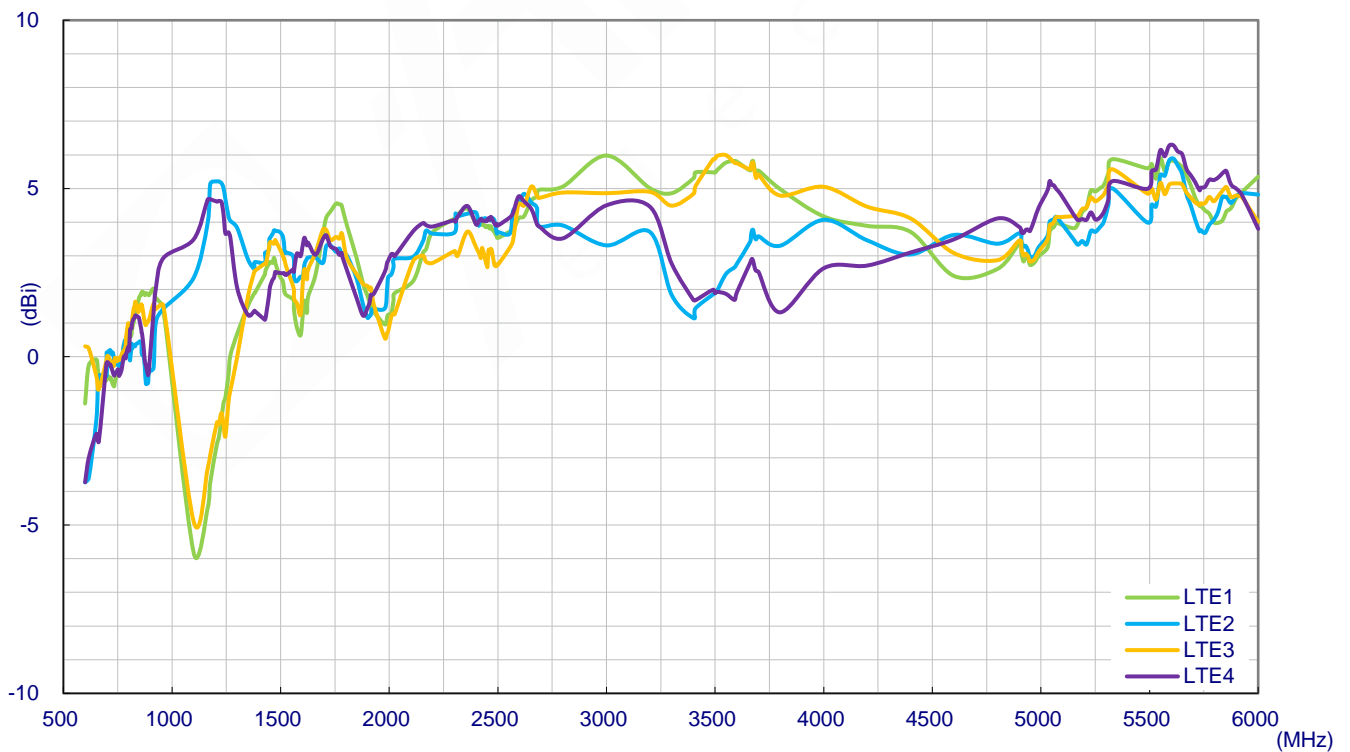

Wi-Fi MIMO

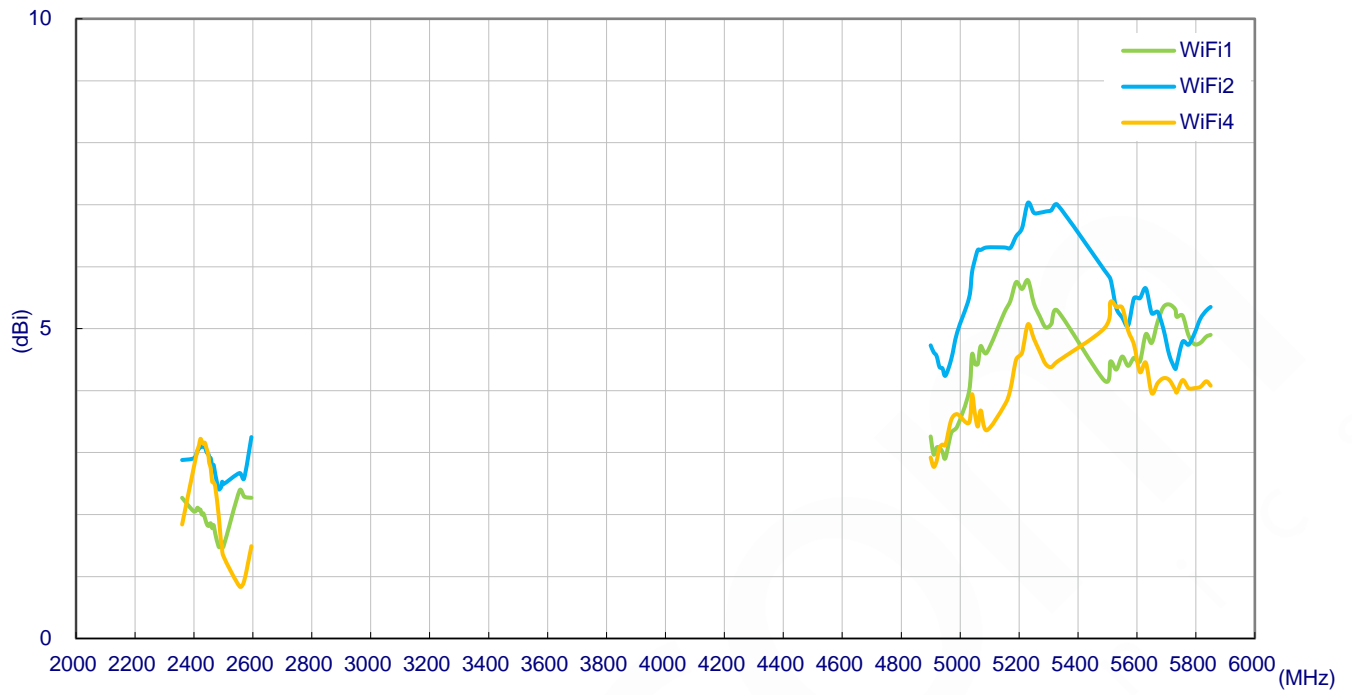

5. Radiation Patterns

5.1 Test Setup

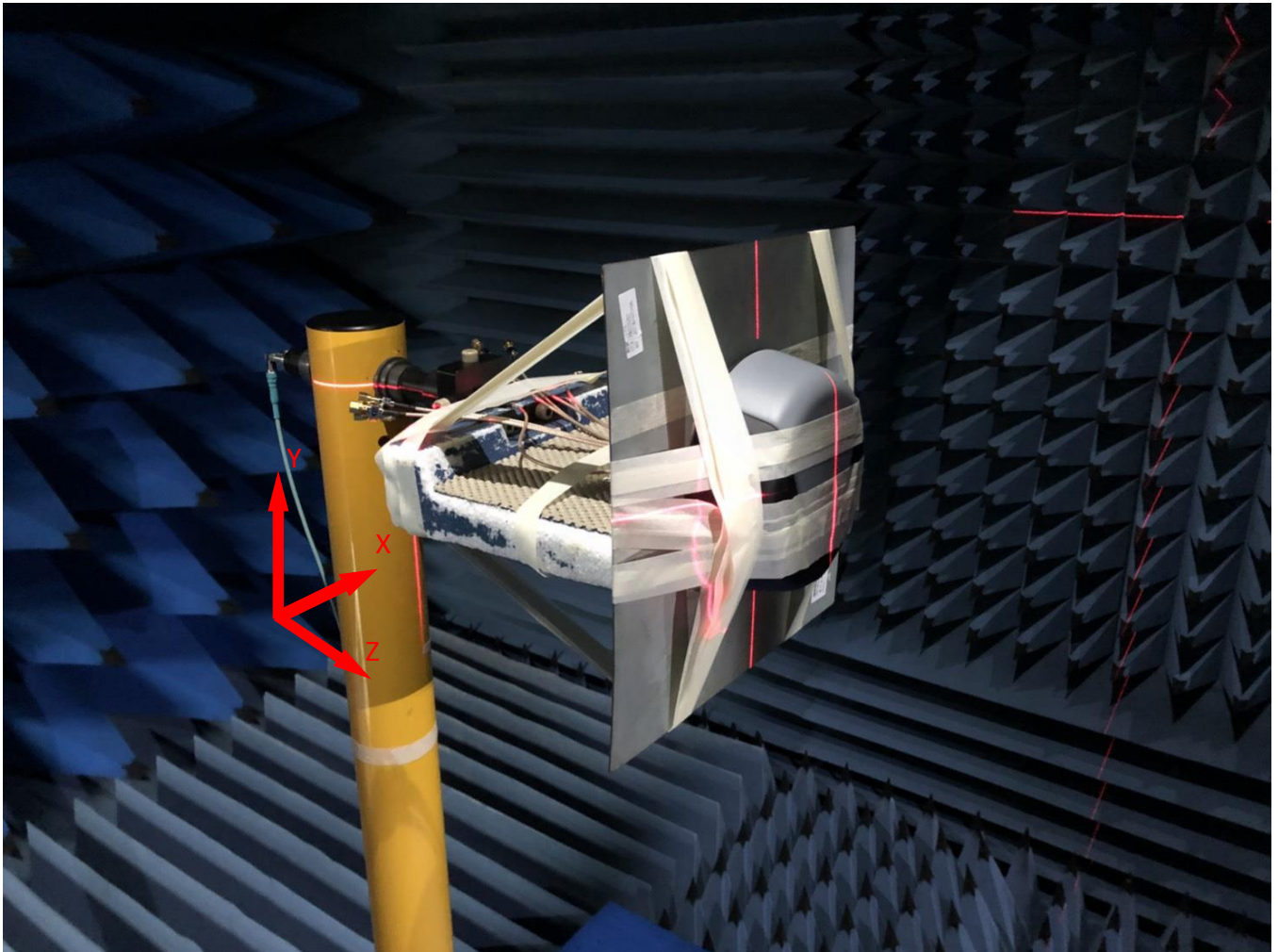

On 30x30cm Ground Plane

5.2 5G/4G MIMO 1 Radiation Pattern

663MHz

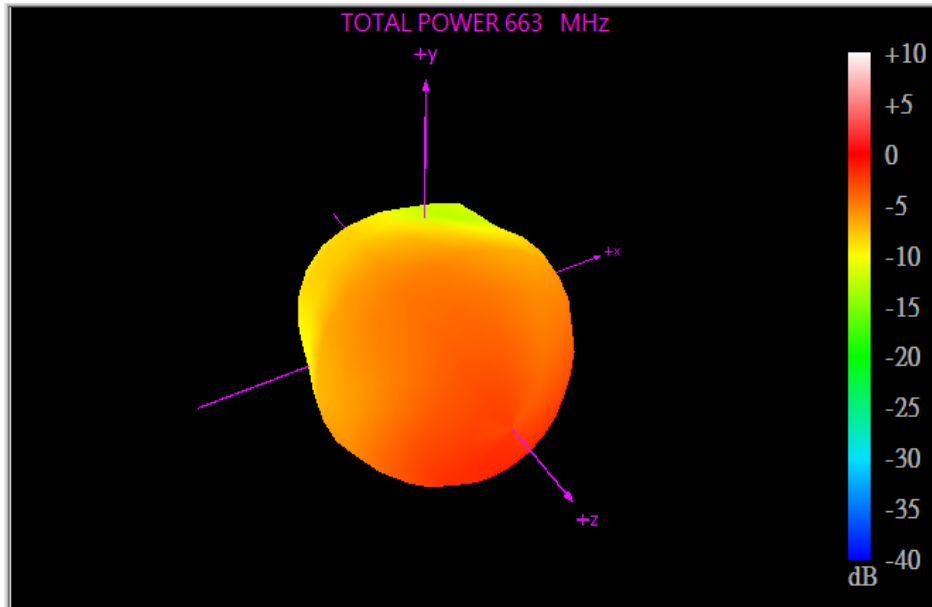

XY Plane XZ Plane YZ Plane

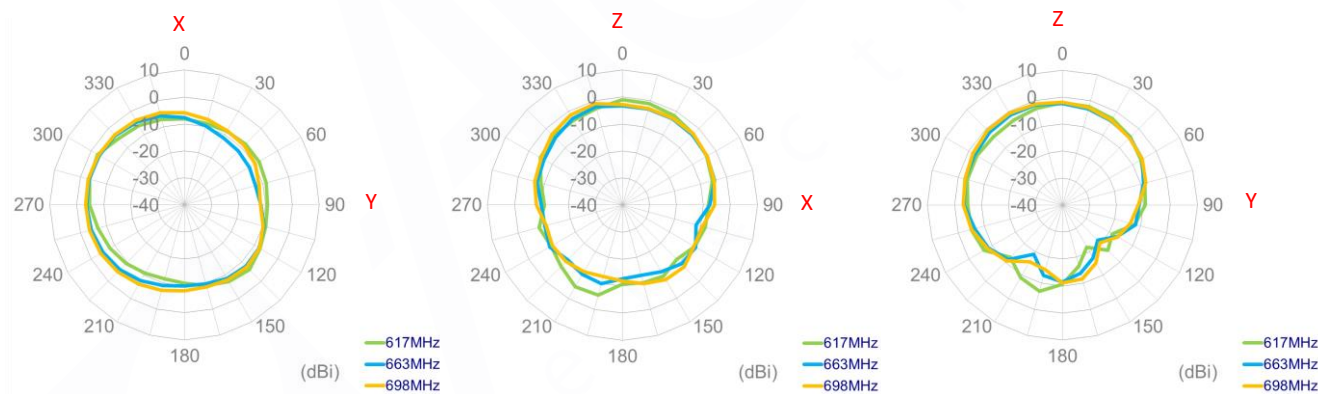

751MHz

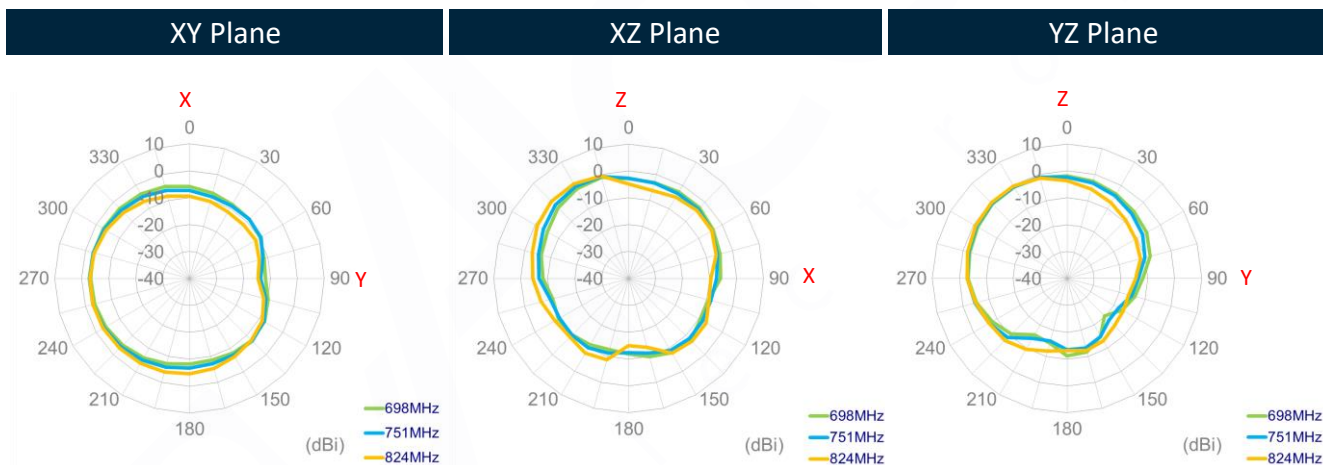
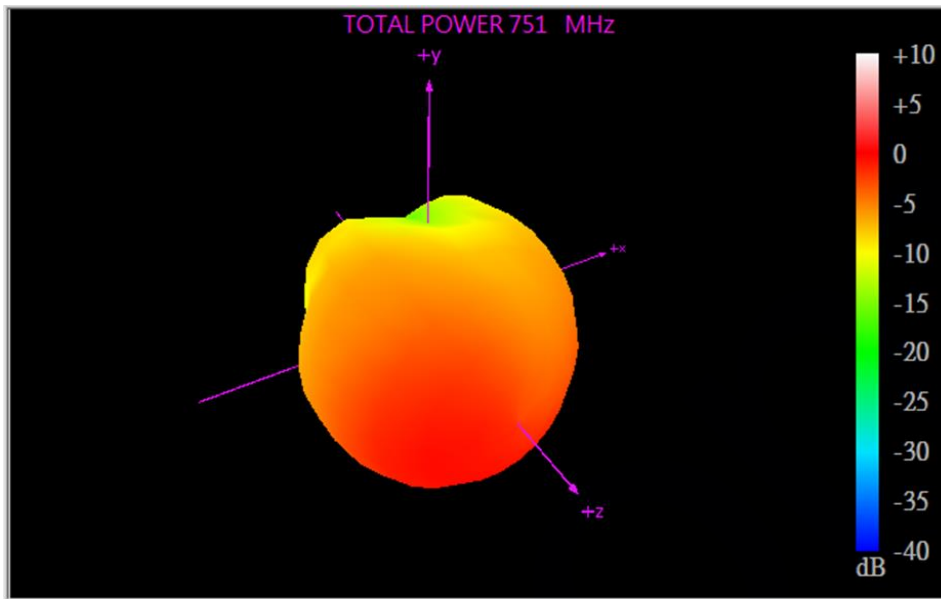

880MHz

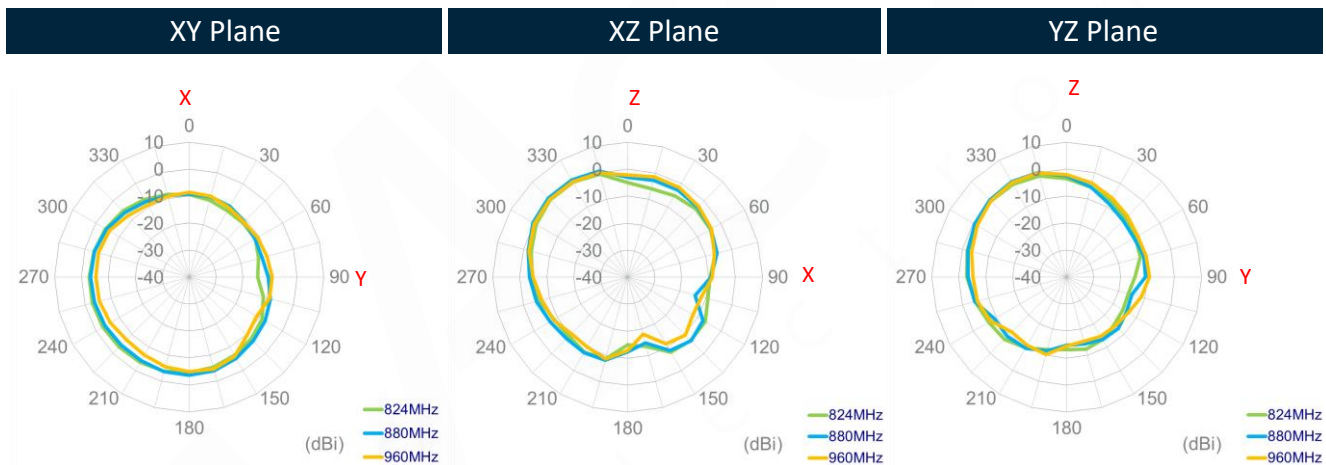
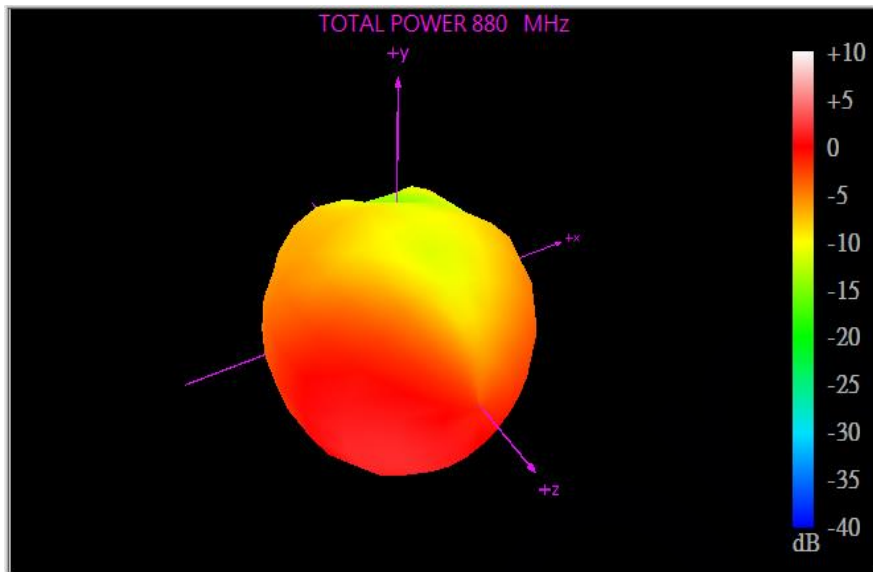

1467MHz

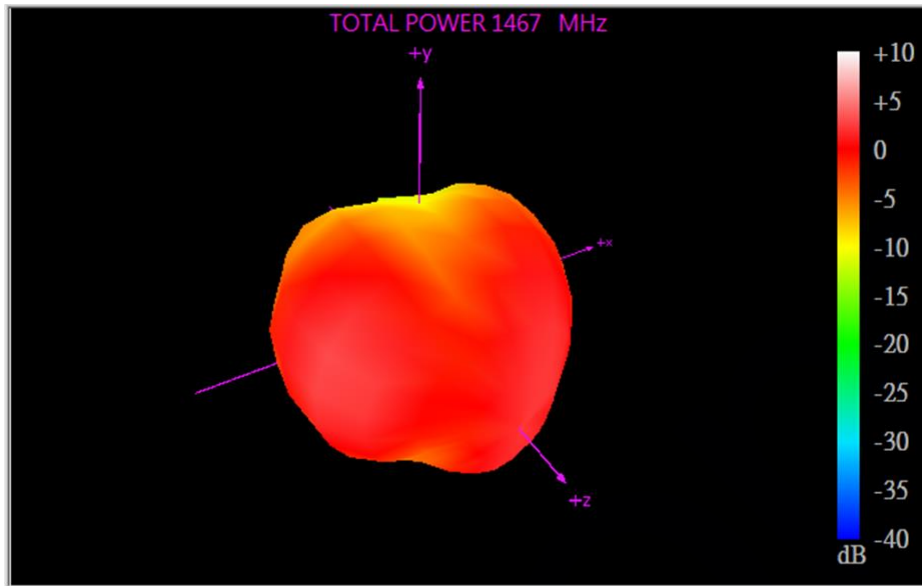

XY Plane XZ Plane YZ Plane

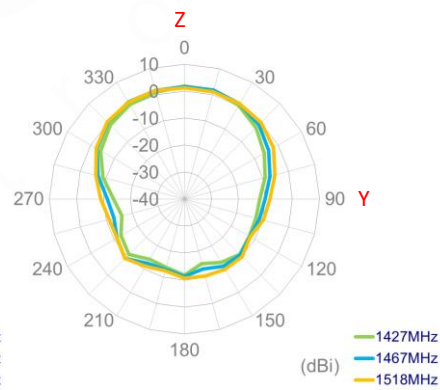
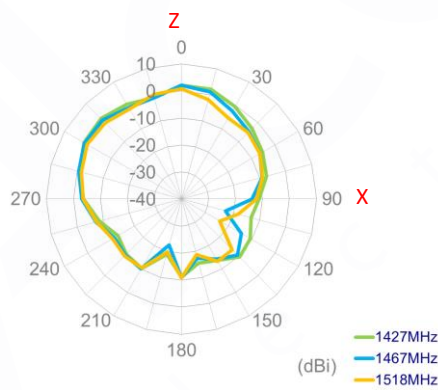
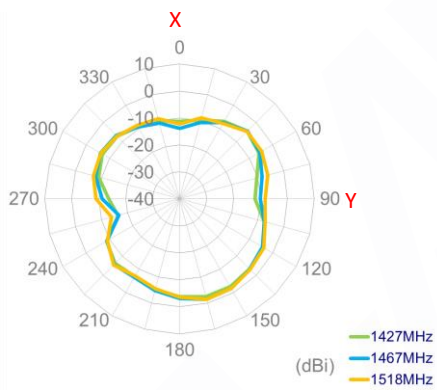

1805MHz

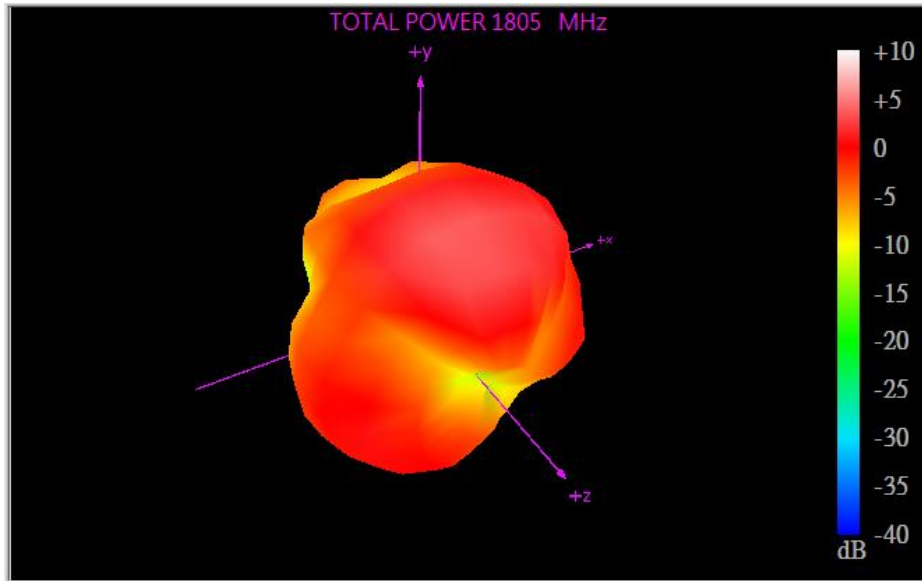

XY Plane XZ Plane YZ Plane

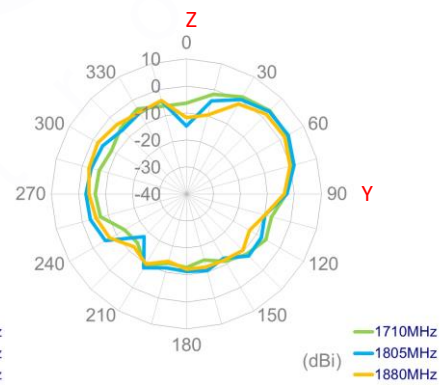
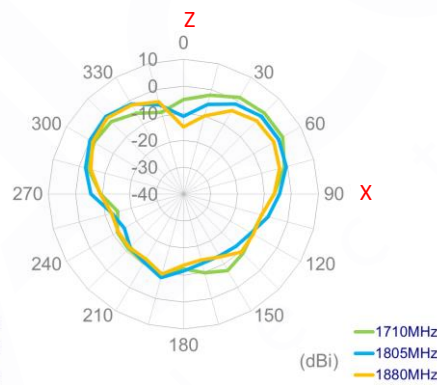
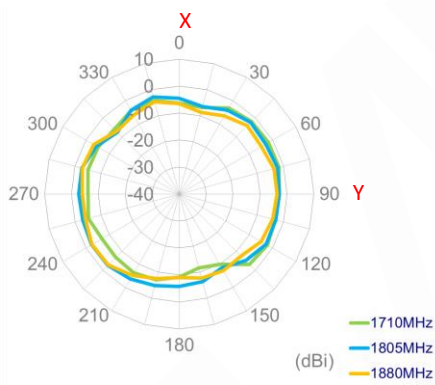

1920MHz

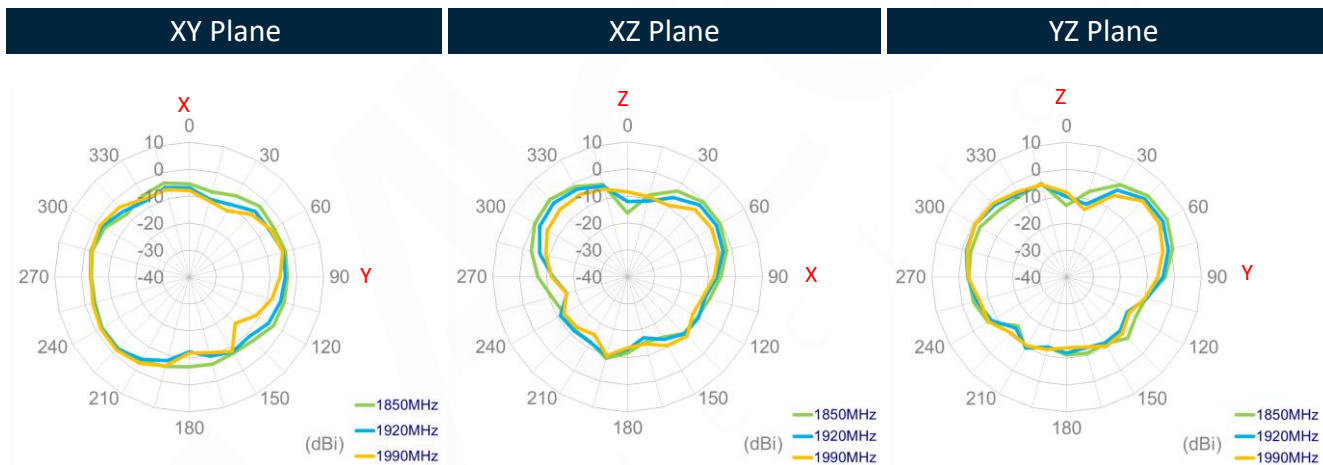
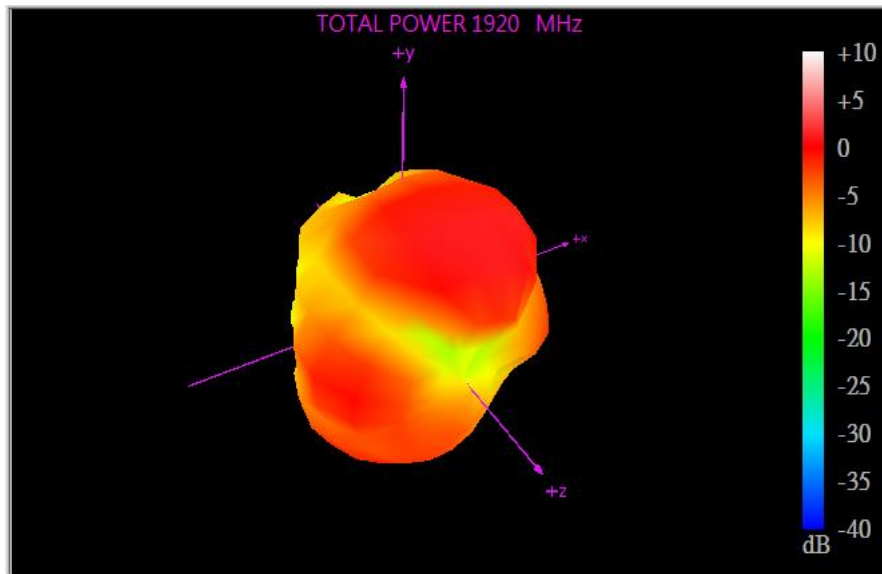

2010MHz

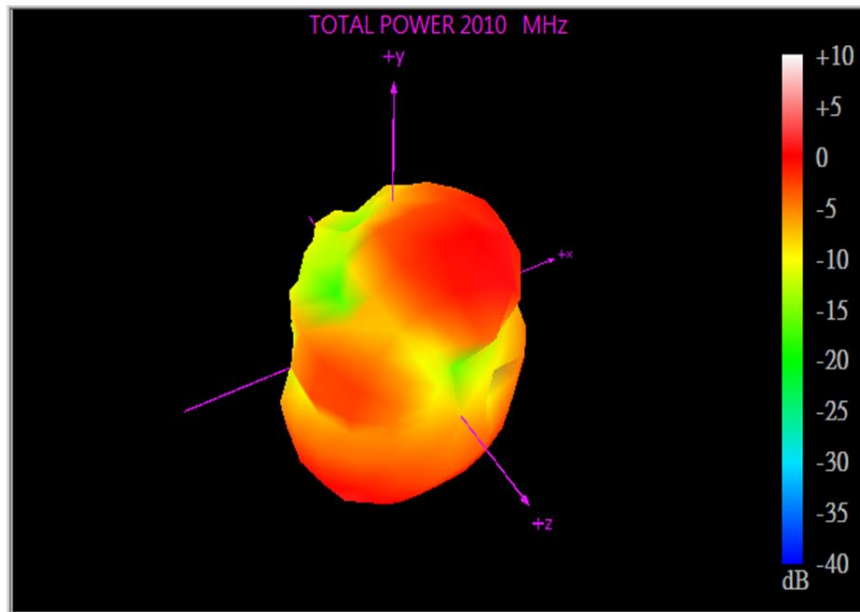

XY Plane	XZ Plane	YZ Plane
----------	----------	----------

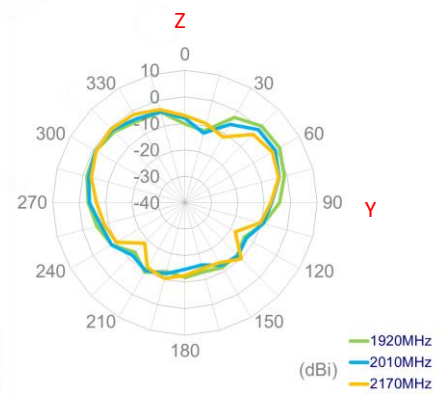
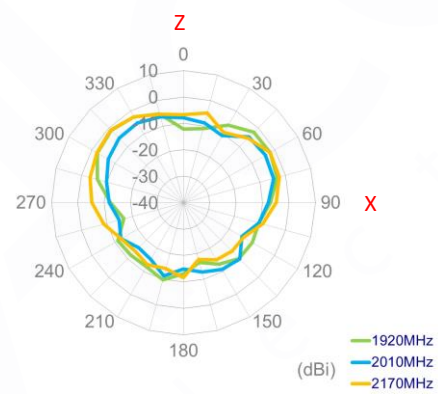
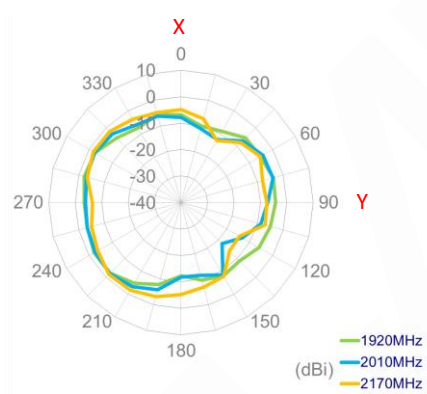

2500MHz

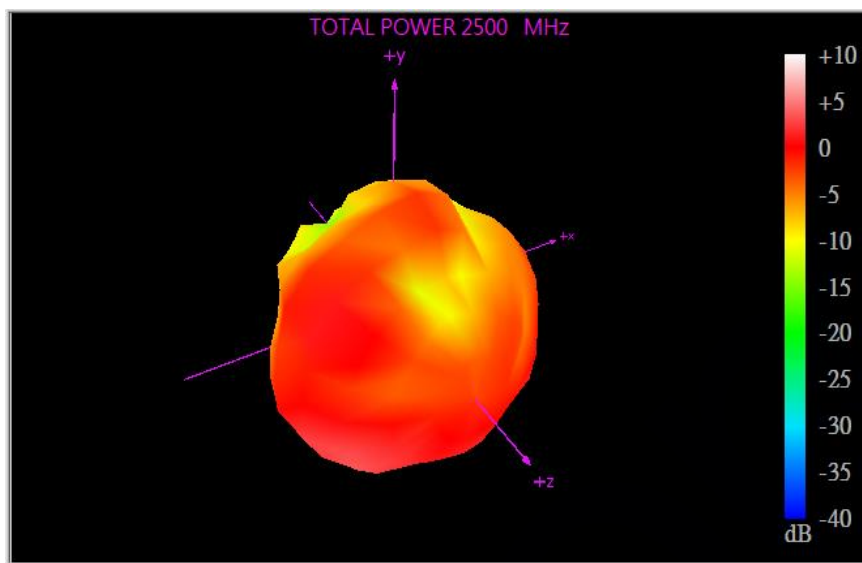

XY Plane XZ Plane YZ Plane

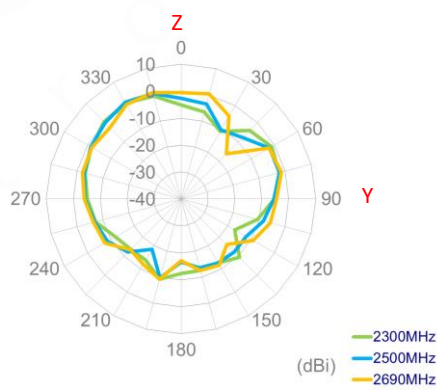
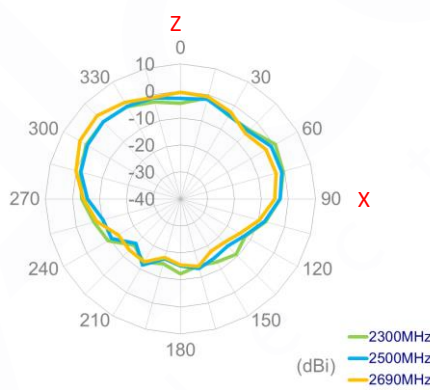
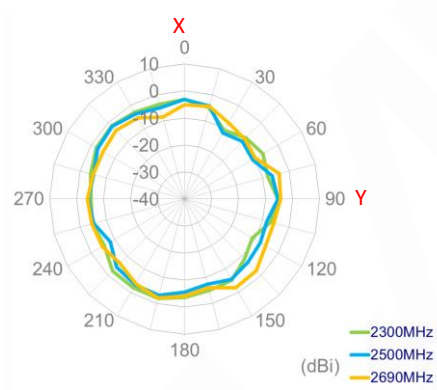

3300MHz

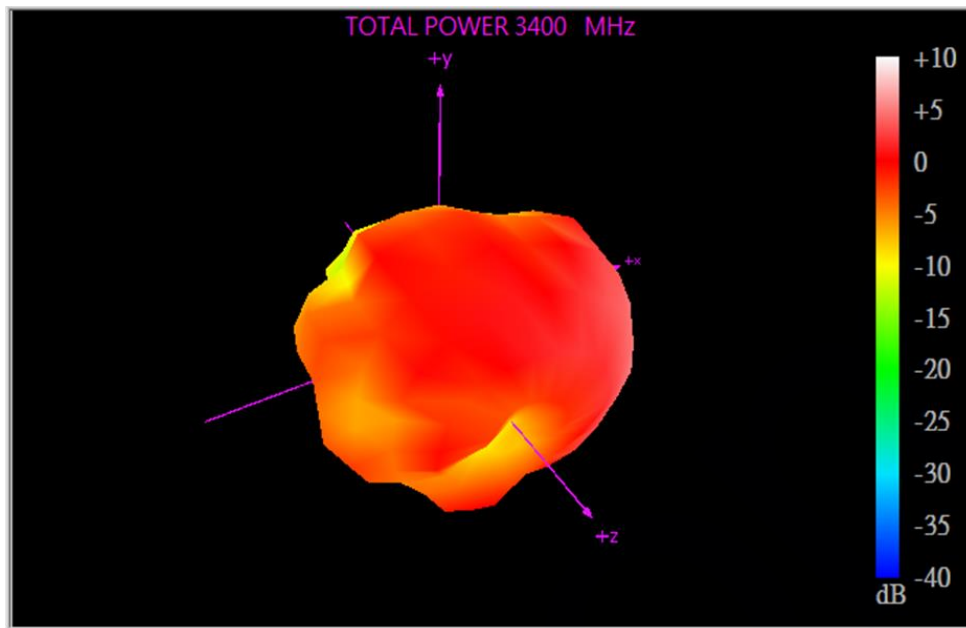

XY Plane XZ Plane YZ Plane

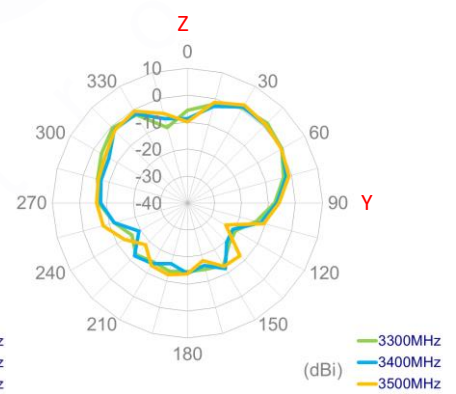
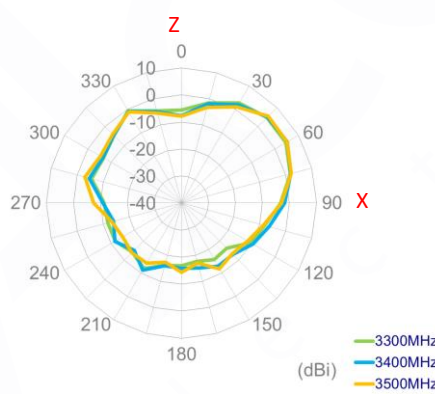
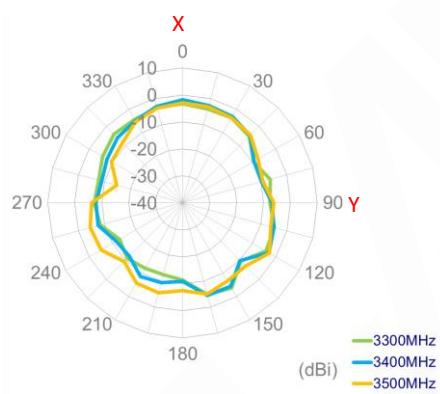

5550MHz

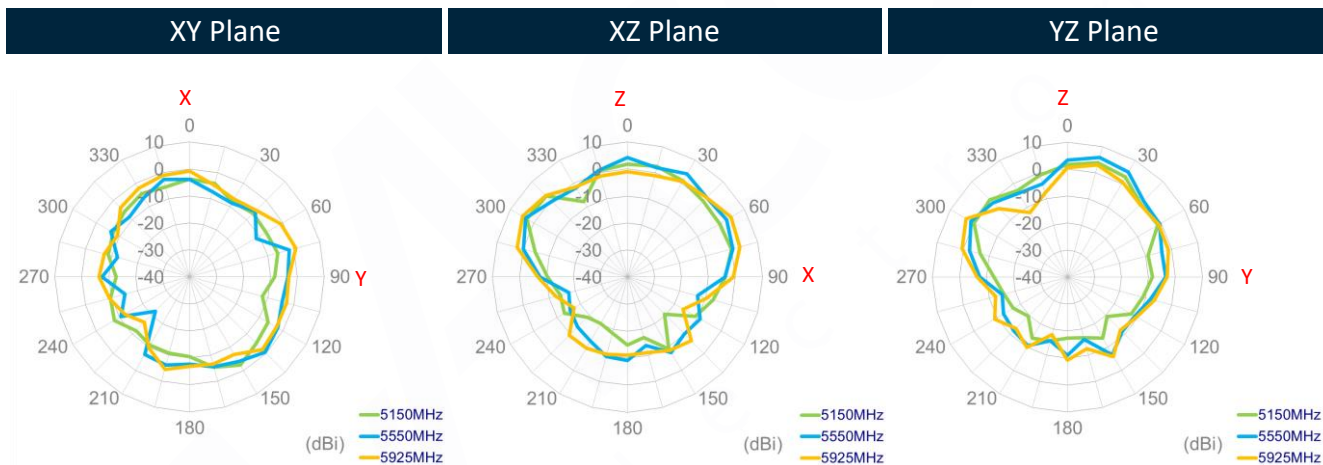
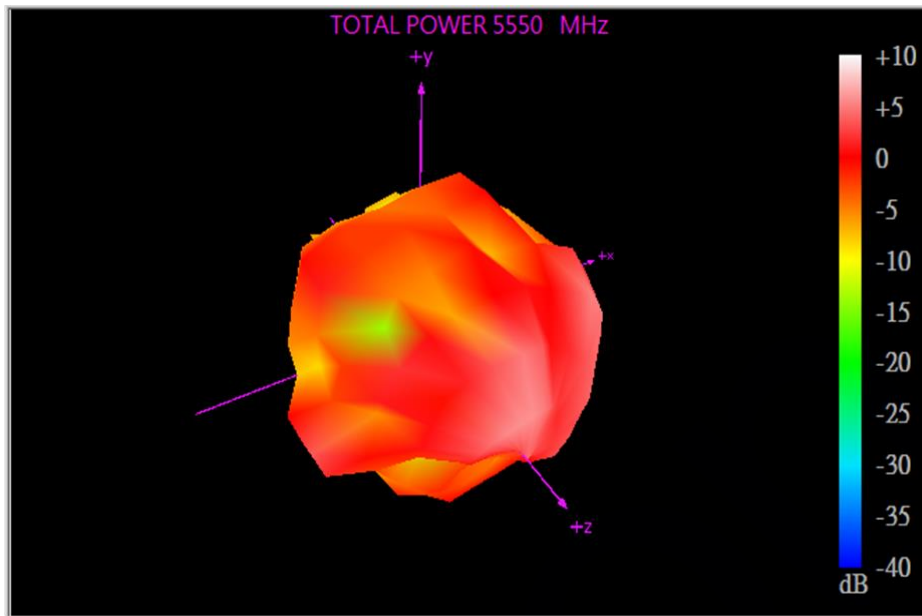

5.3 5G/4G MIMO 2 Radiation Pattern

663MHz

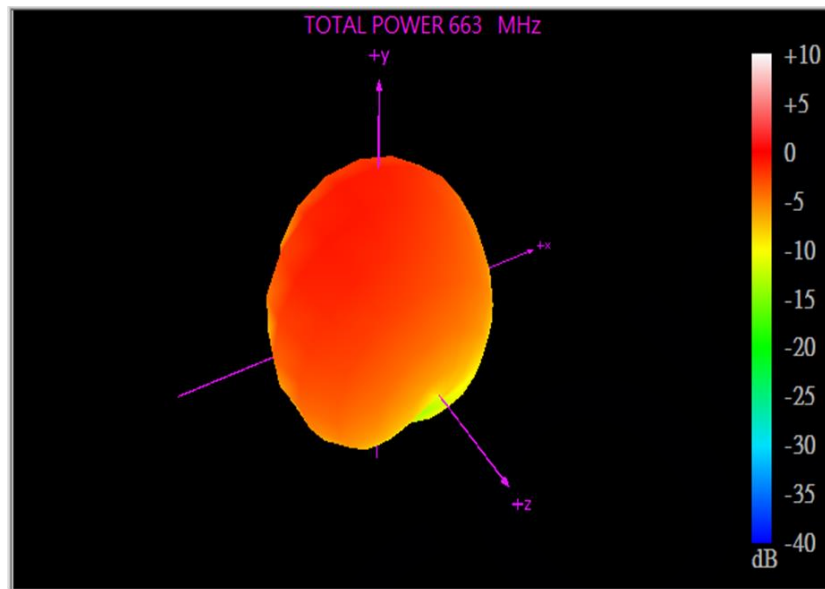

XY Plane XZ Plane YZ Plane

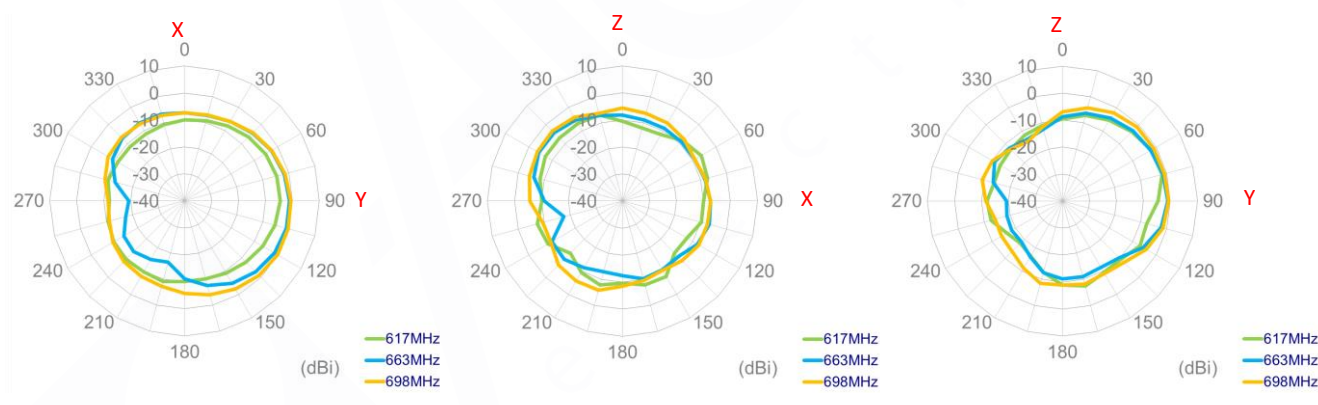

751MHz

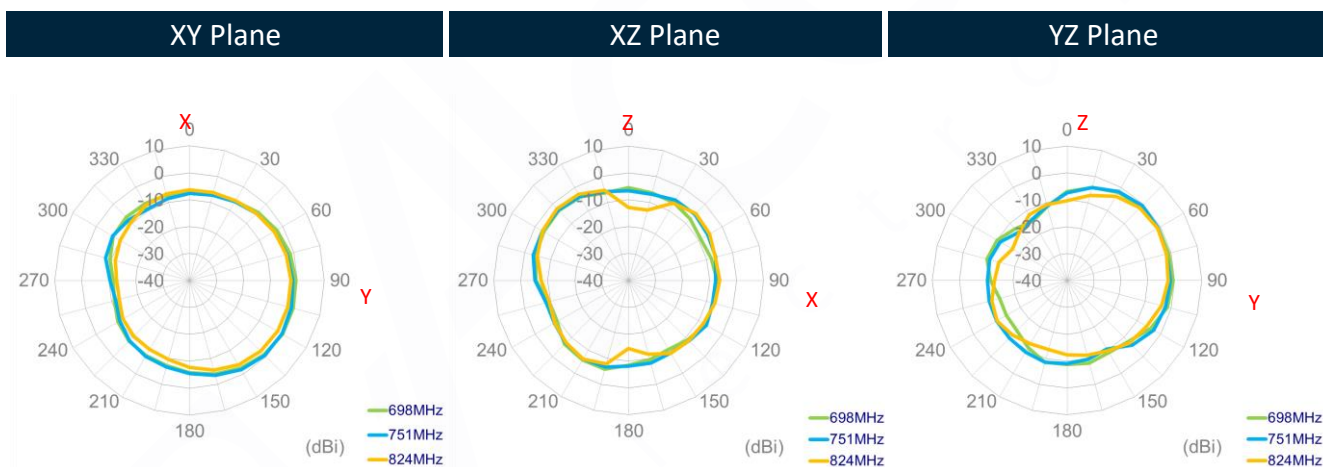
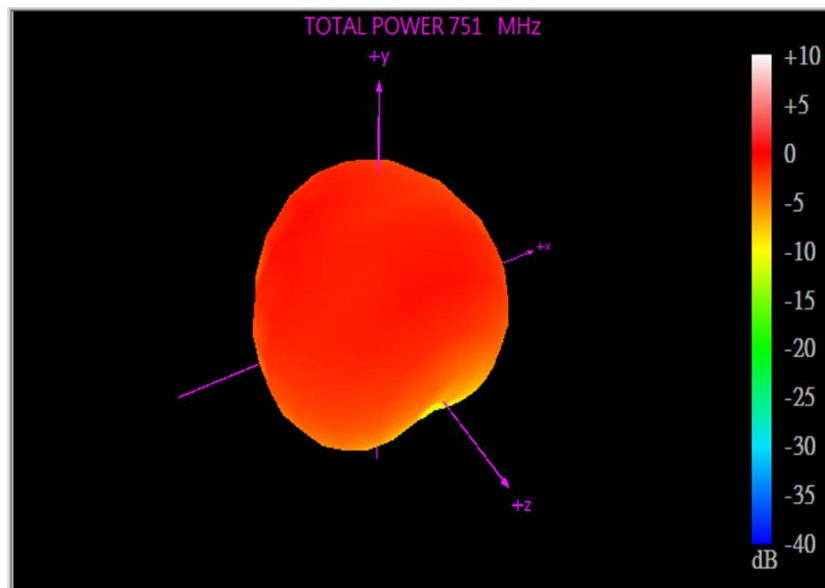

880MHz

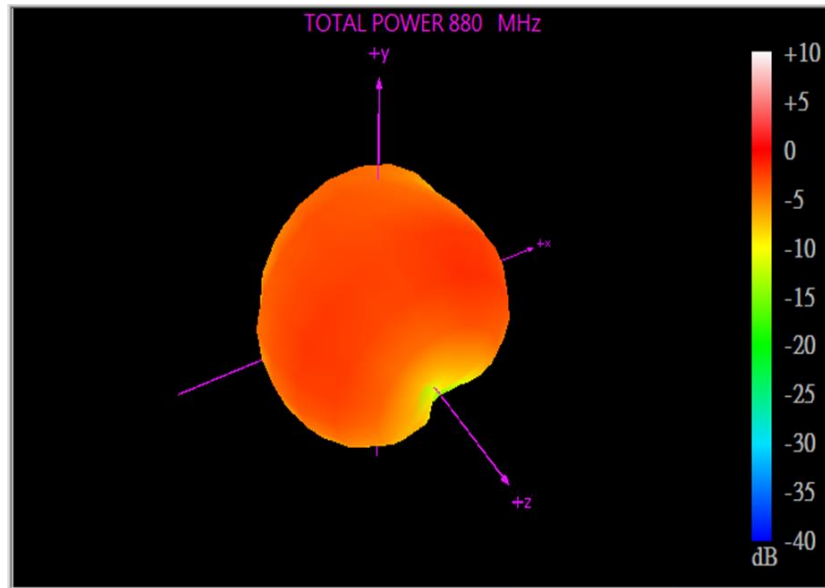

XY Plane XZ Plane YZ Plane

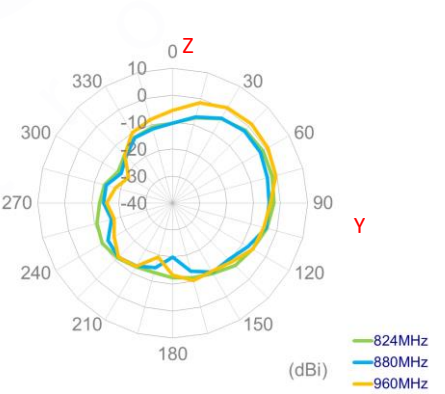
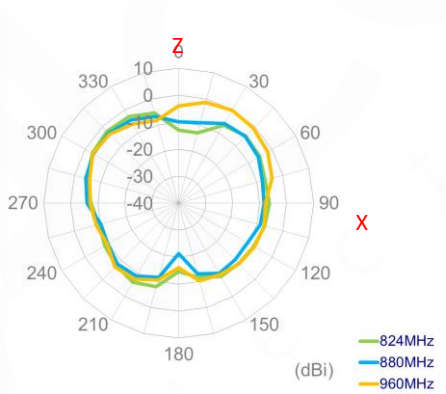
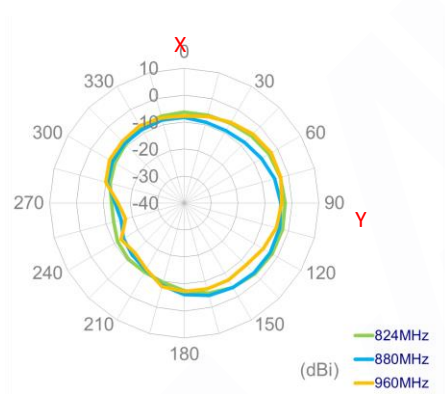

1467MHz

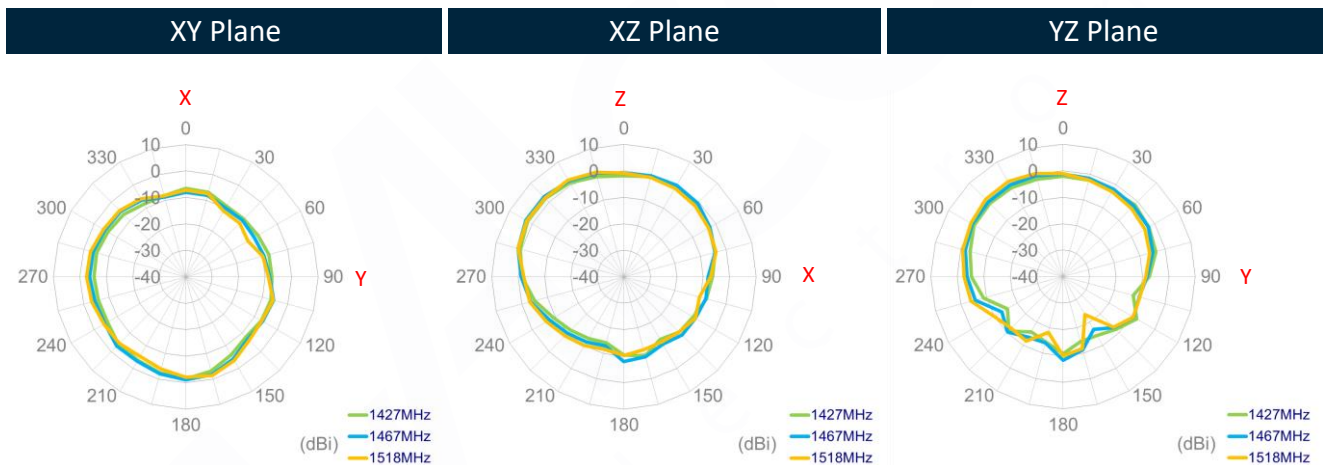
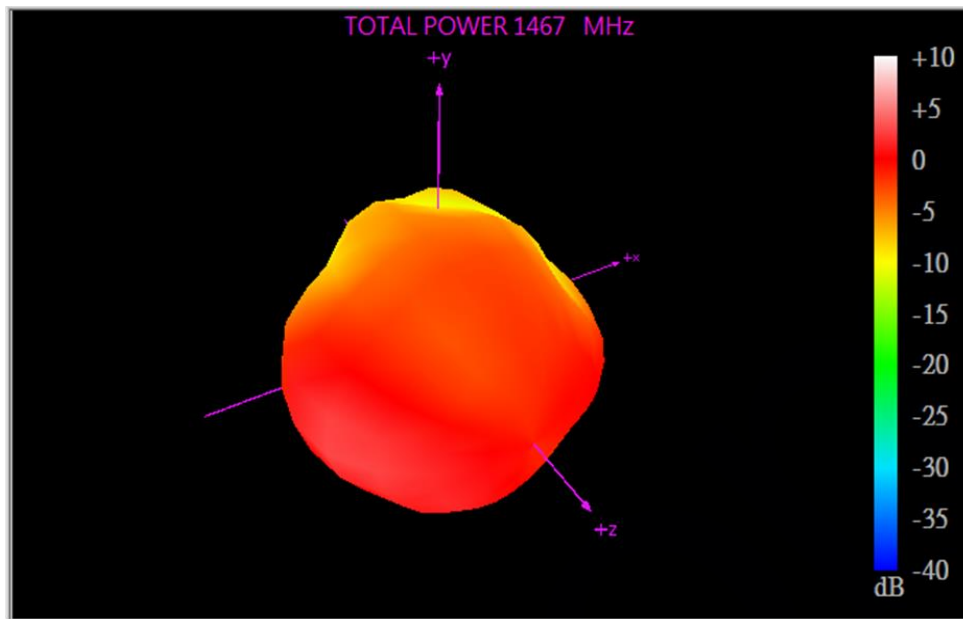

1805MHz

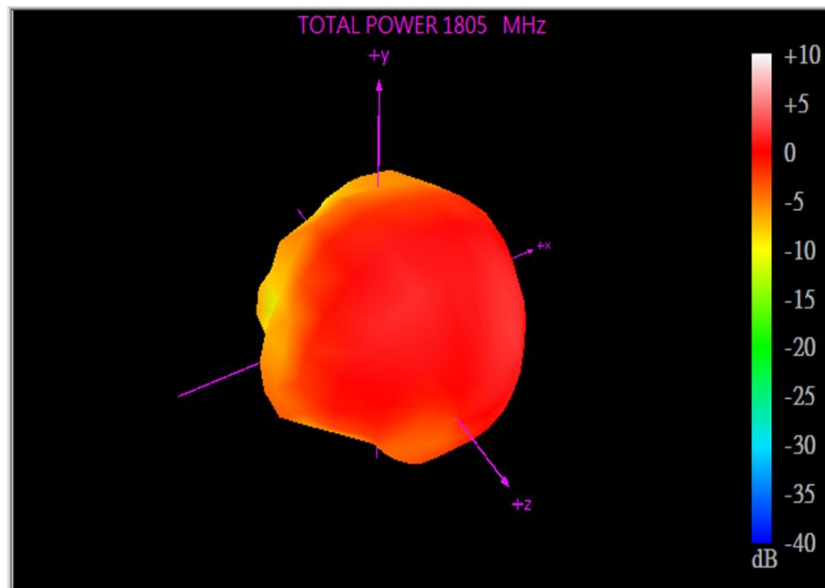

XY Plane XZ Plane YZ Plane

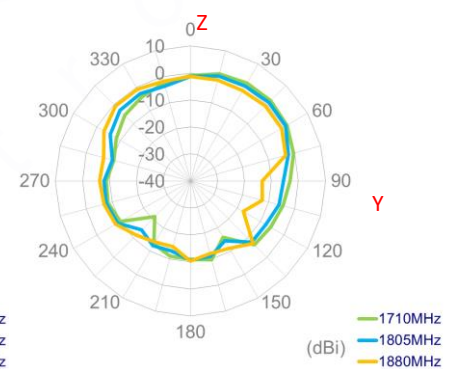
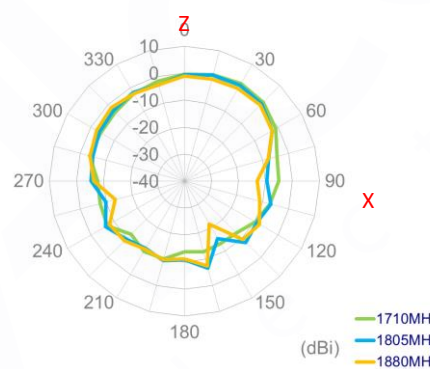
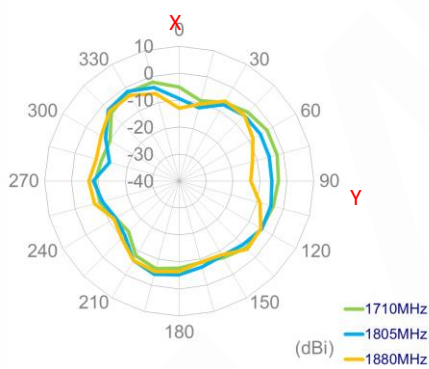

1920MHz

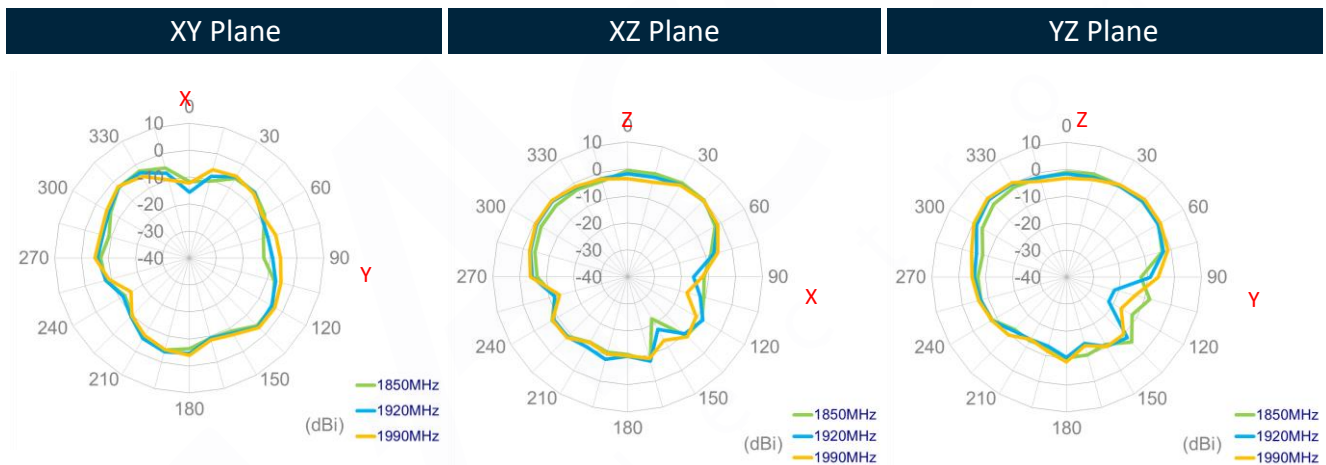
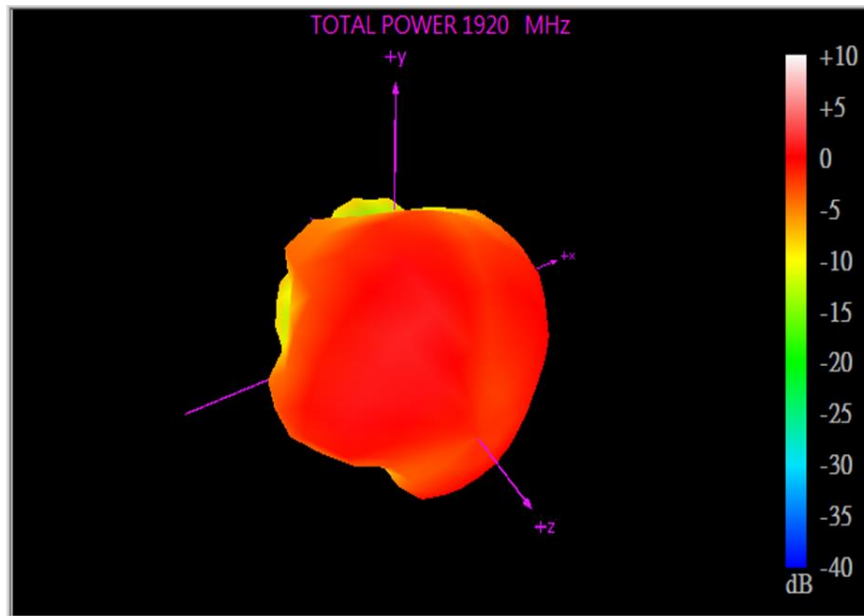

2010MHz

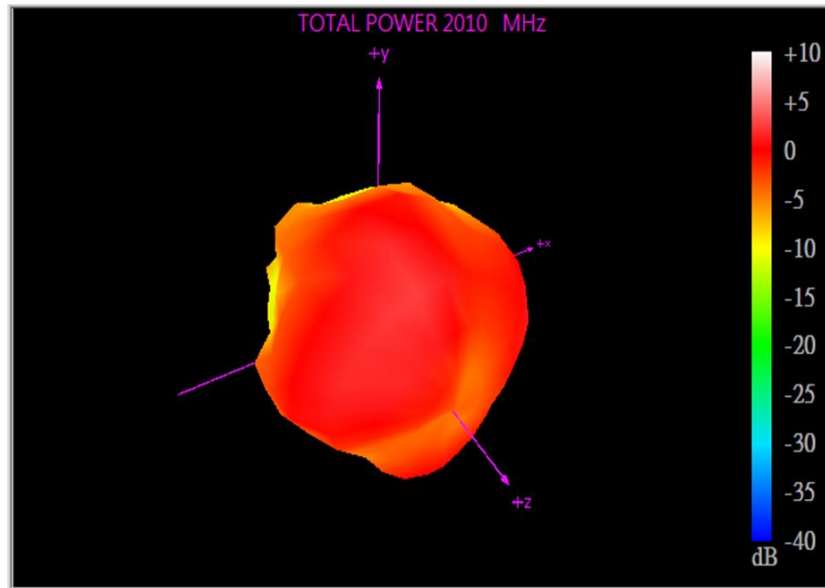

XY Plane XZ Plane YZ Plane

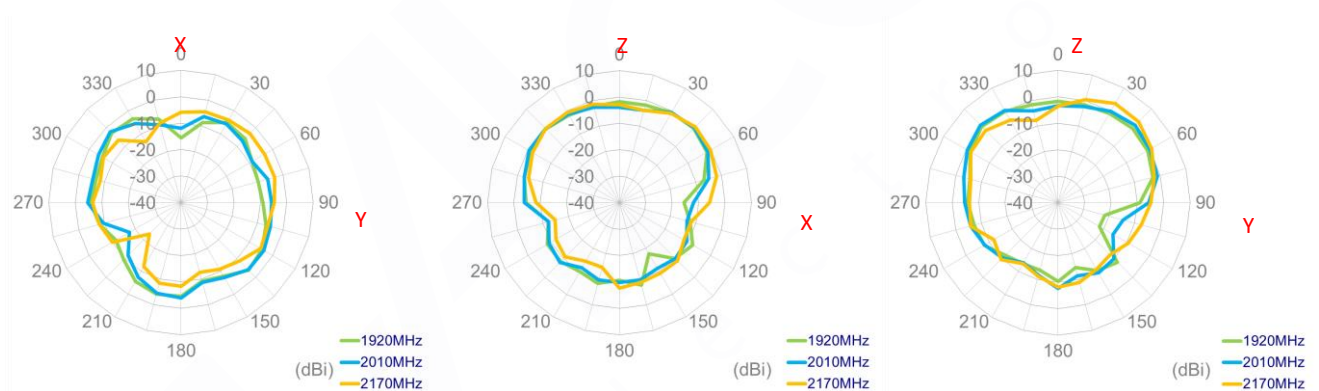

2500MHz

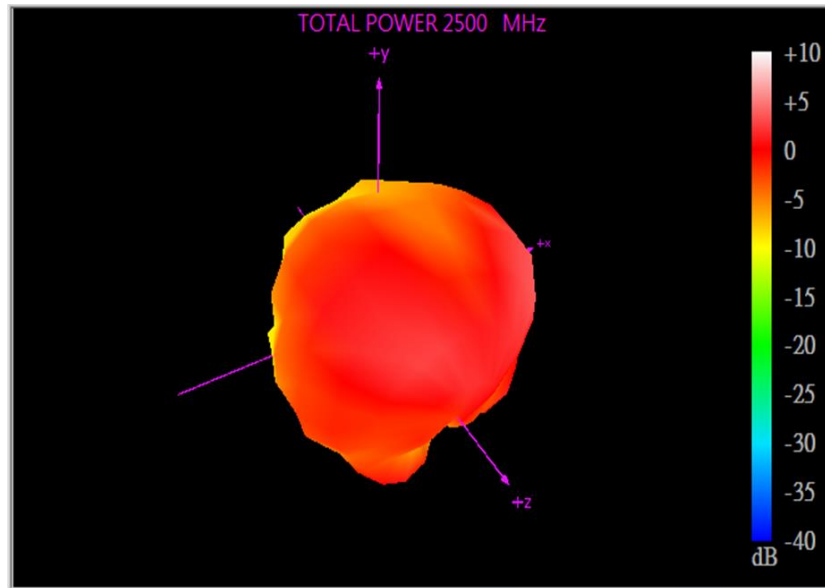

XY Plane

XZ Plane

YZ Plane

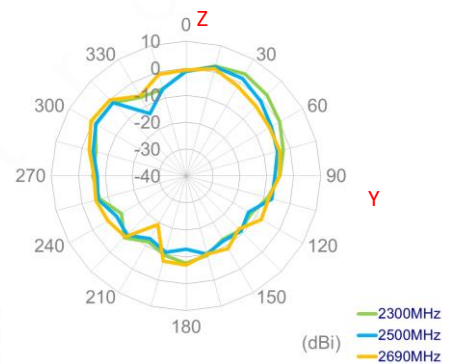
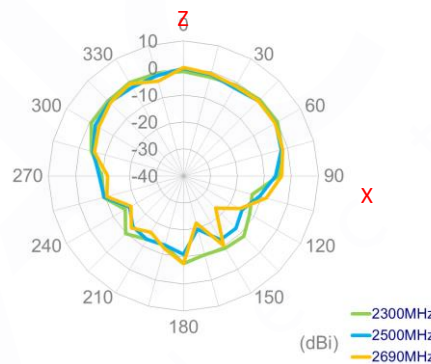
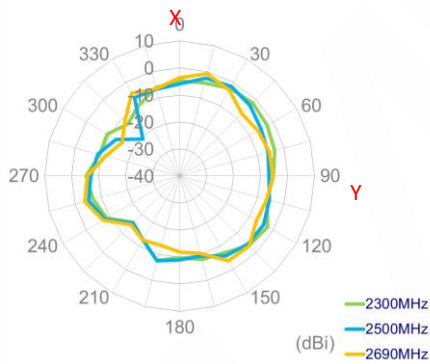

3400MHz

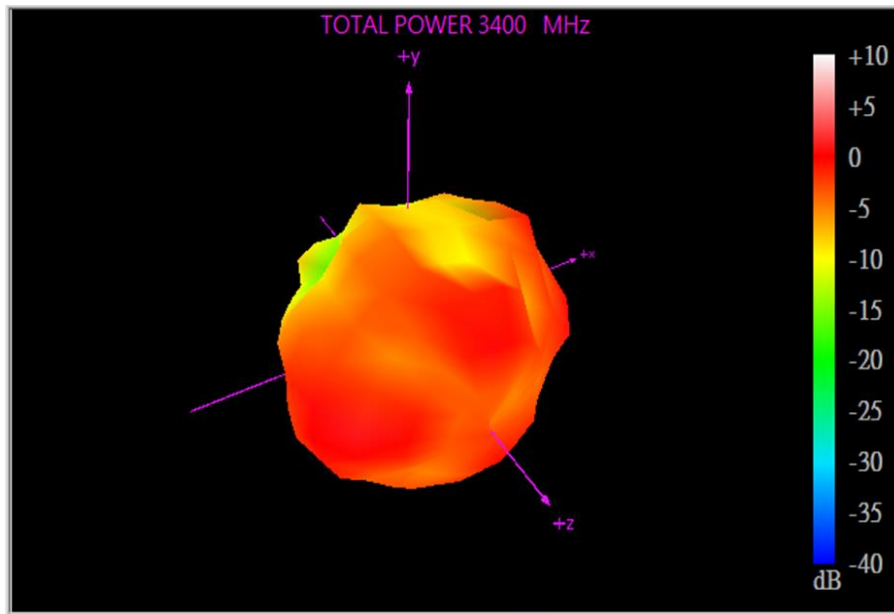

XY Plane XZ Plane YZ Plane

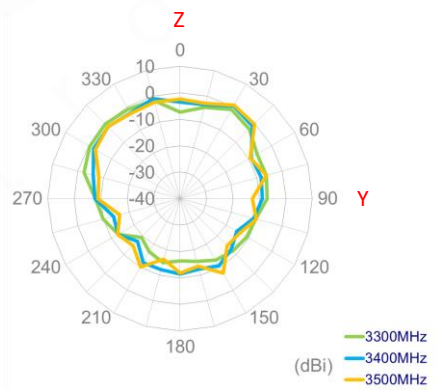
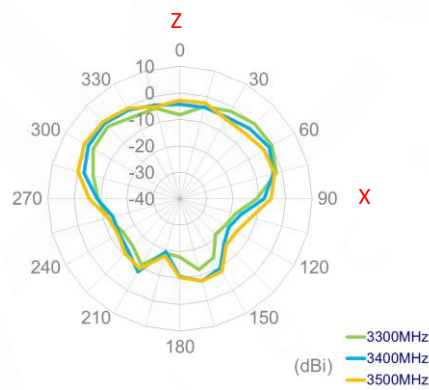
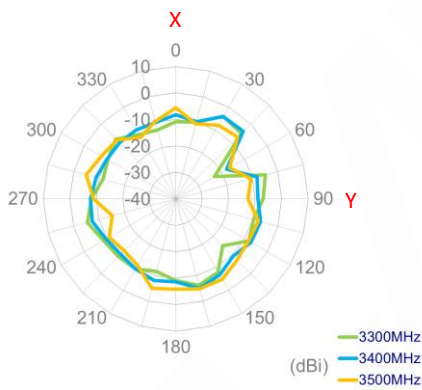

5550MHz

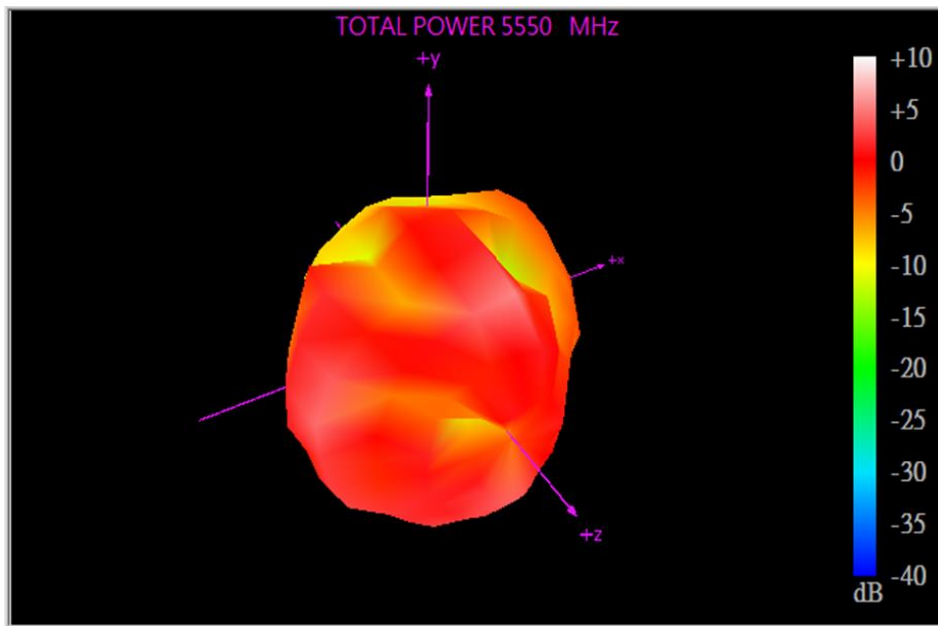

XY Plane XZ Plane YZ Plane

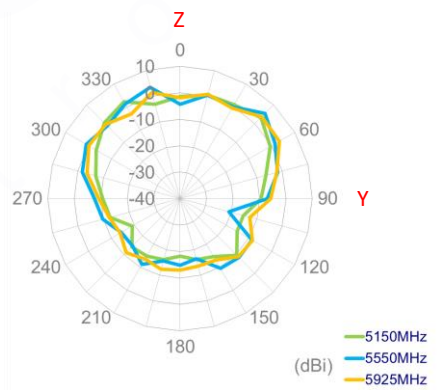
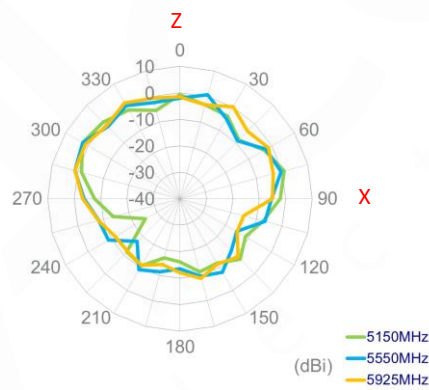
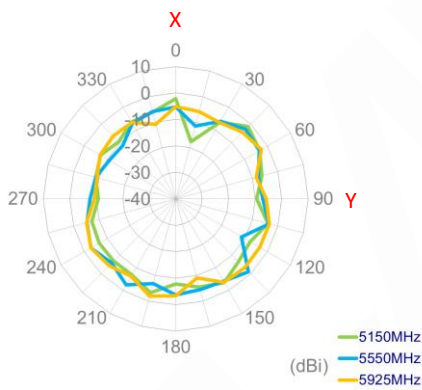

5.4 5G/4G MIMO 3 Radiation Pattern

663MHz

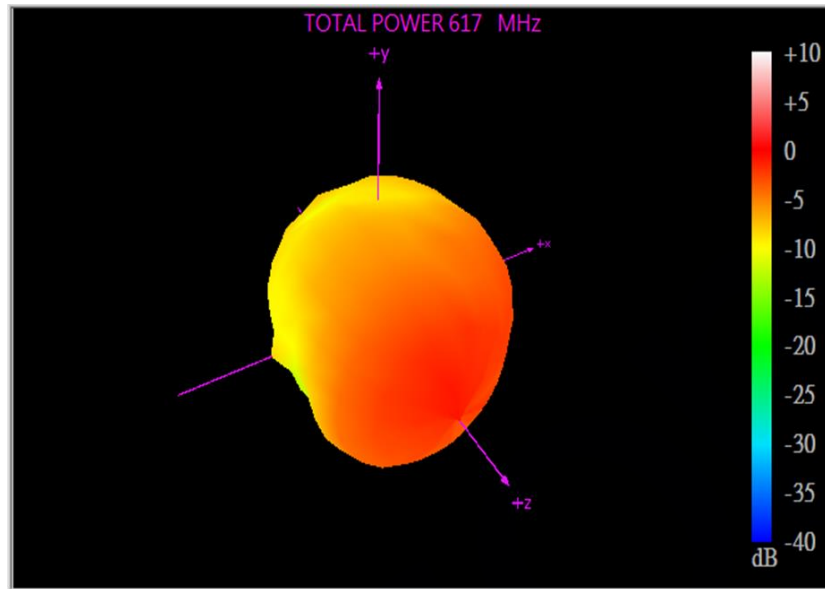

XY Plane XZ Plane YZ Plane

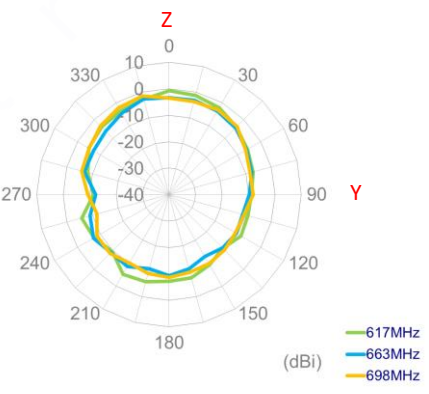
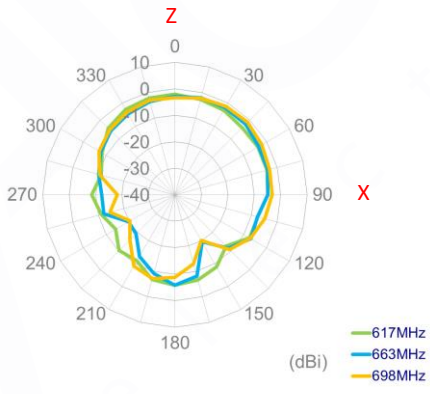
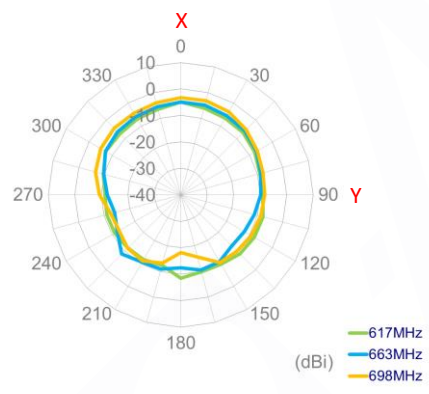

751MHz

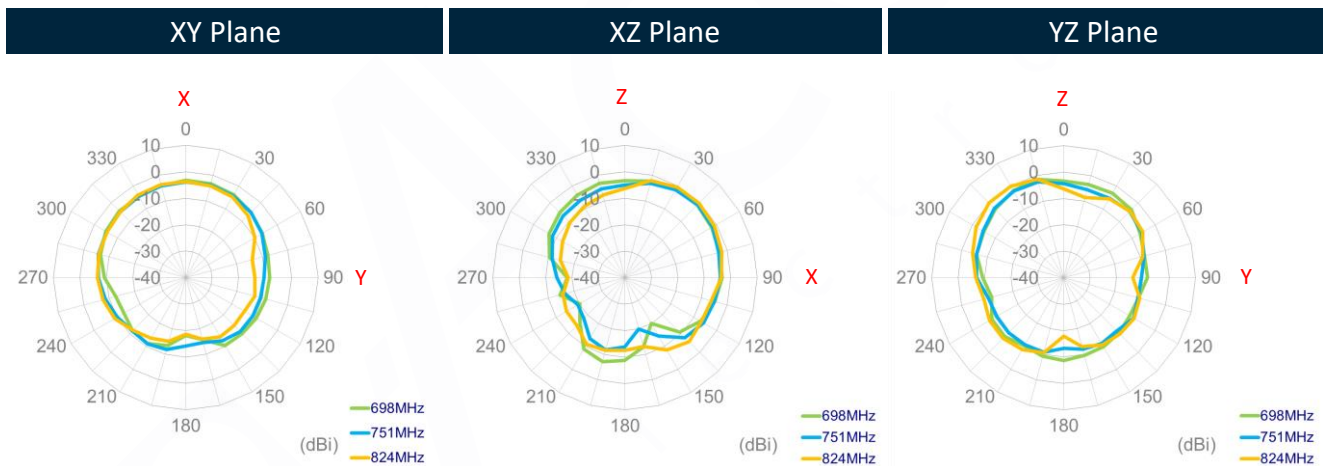
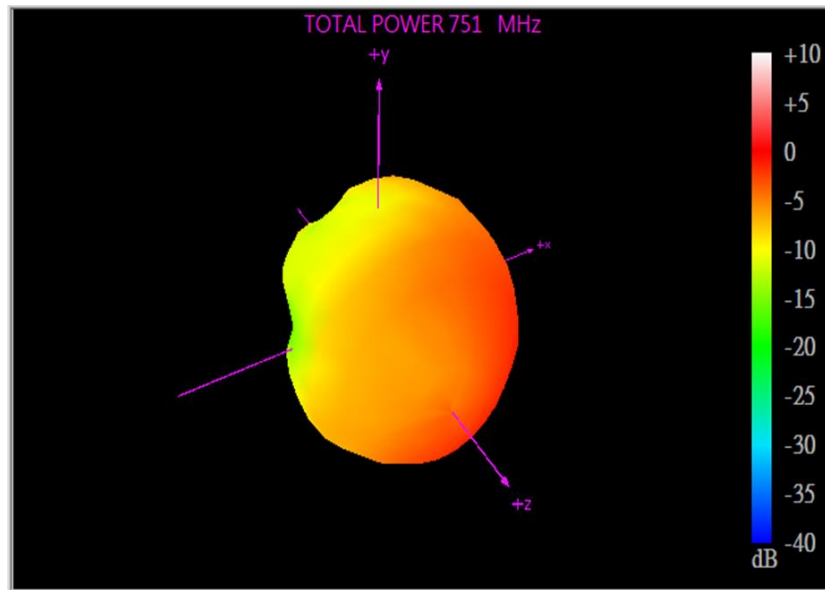

880MHz

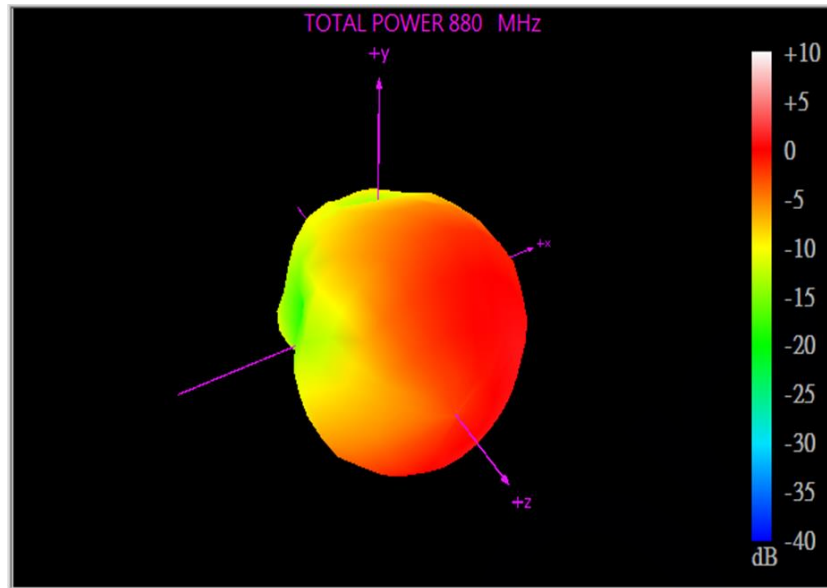

XY Plane XZ Plane YZ Plane

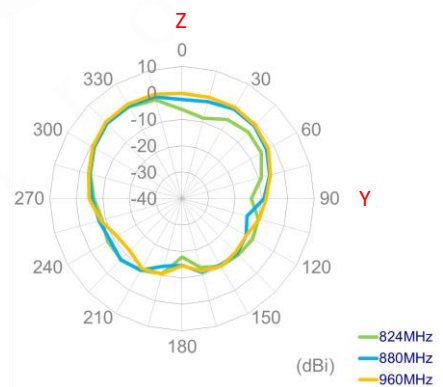
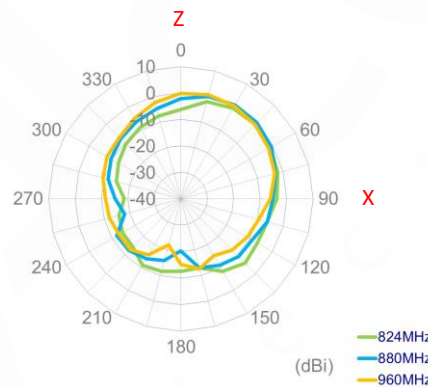
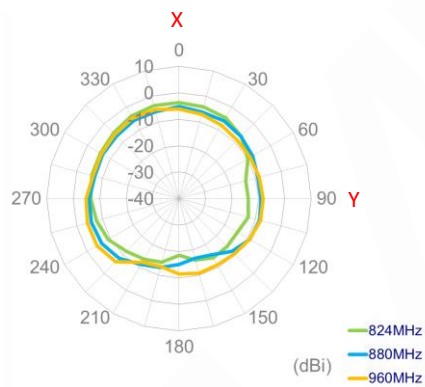

1467MHz

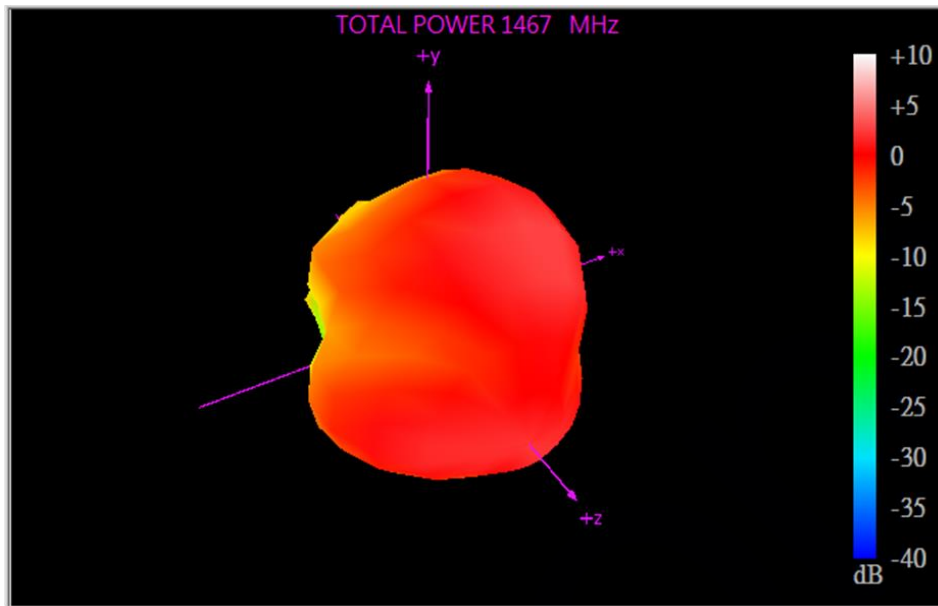

XY Plane XZ Plane YZ Plane

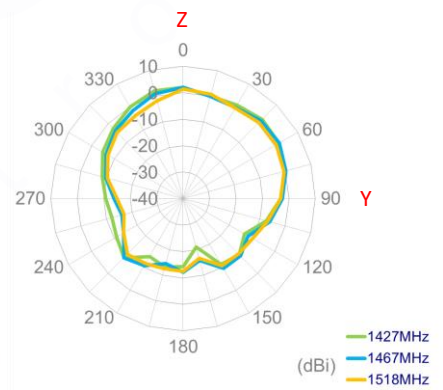
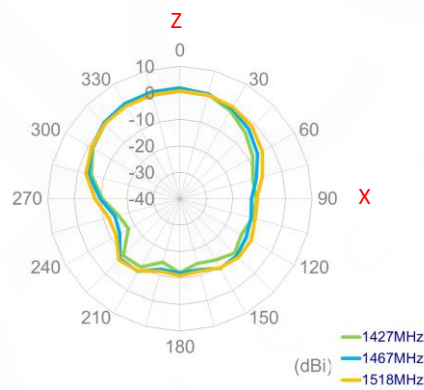
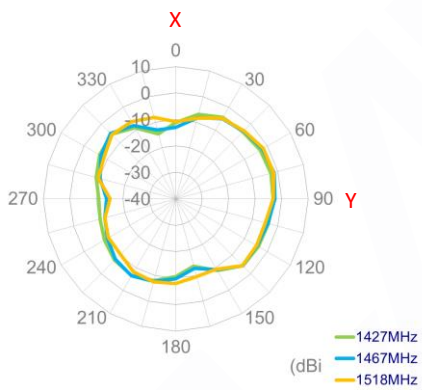

1805MHz

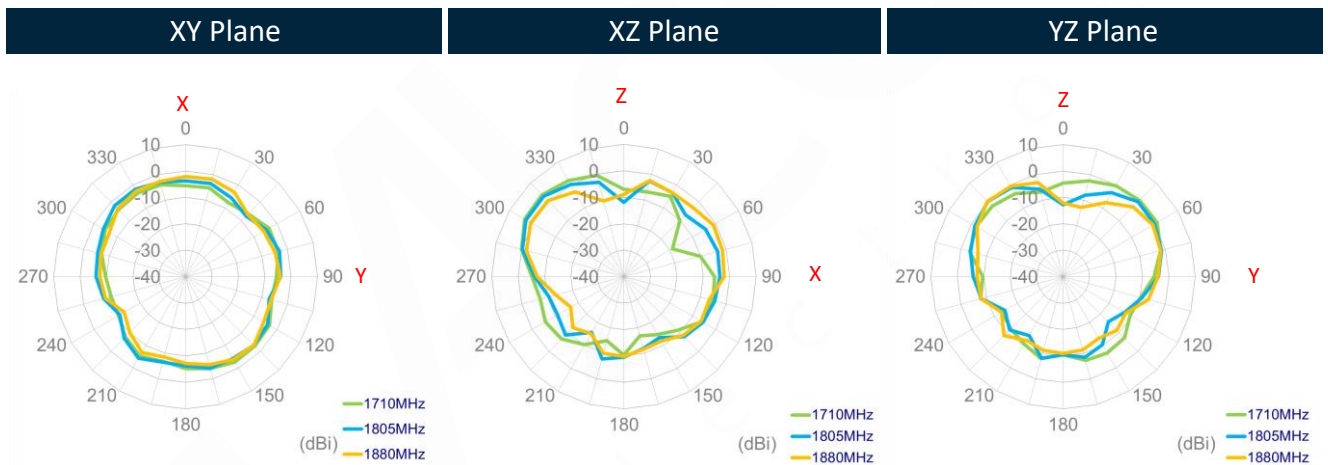
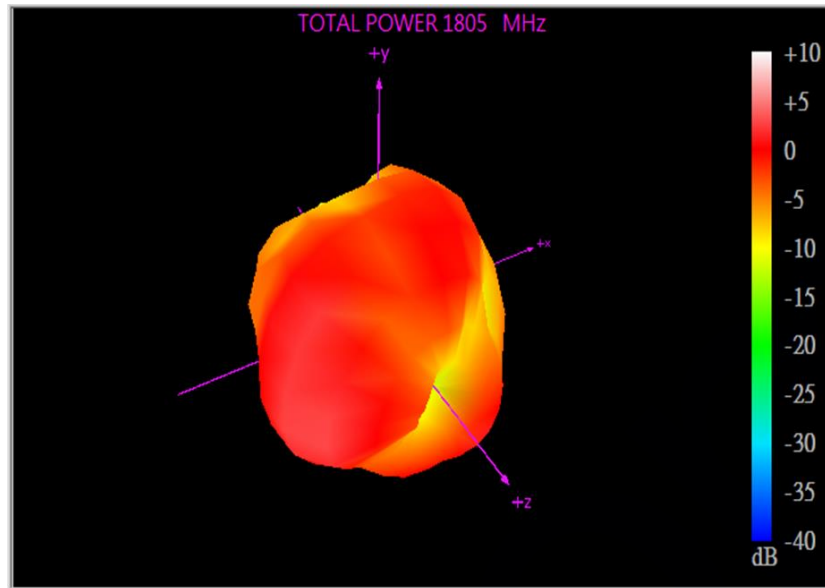

1920MHz

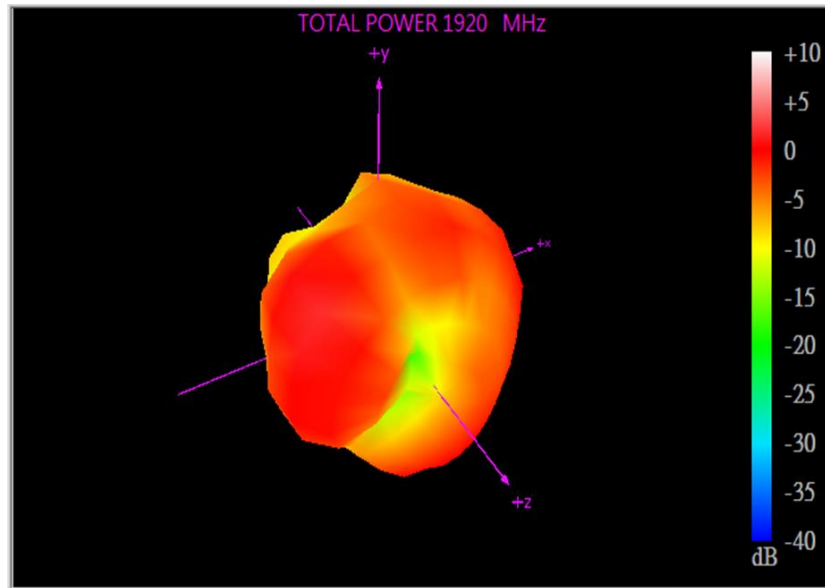

XY Plane XZ Plane YZ Plane

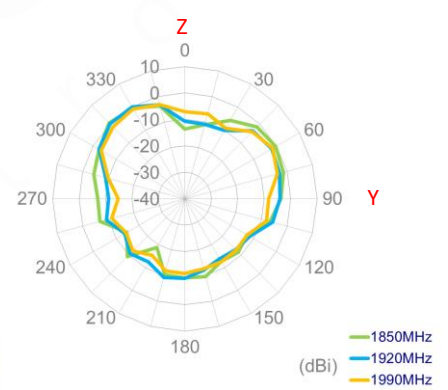
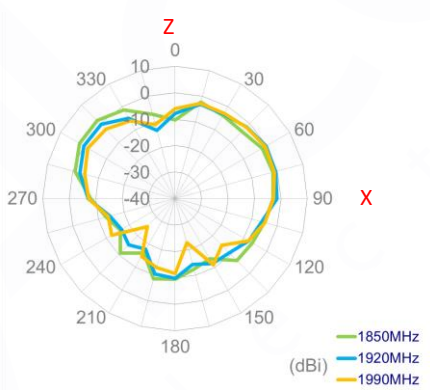
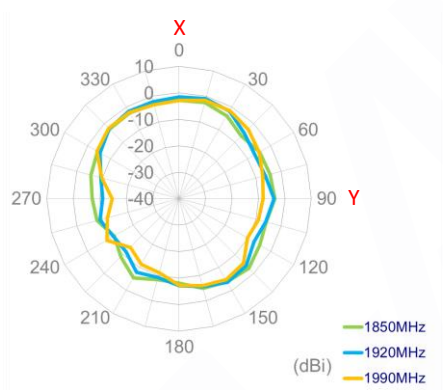

2010MHz

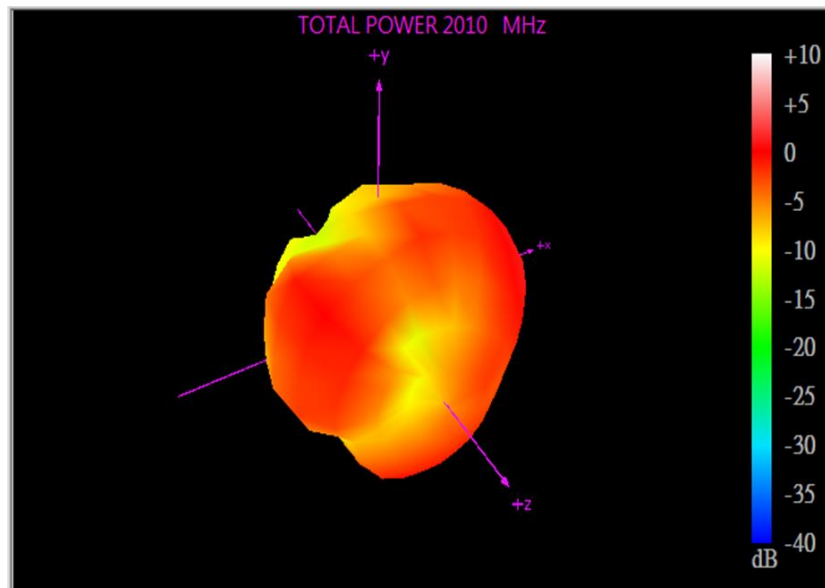

XY Plane XZ Plane YZ Plane

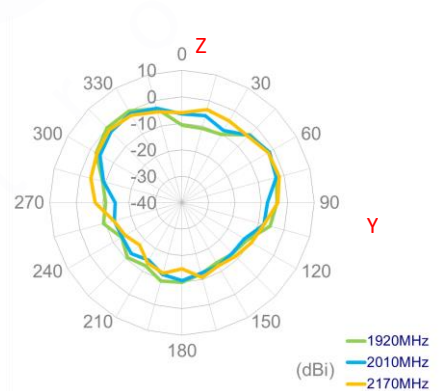
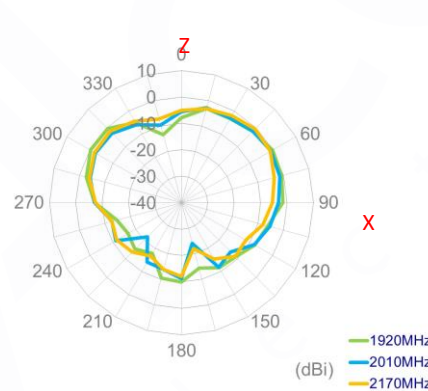
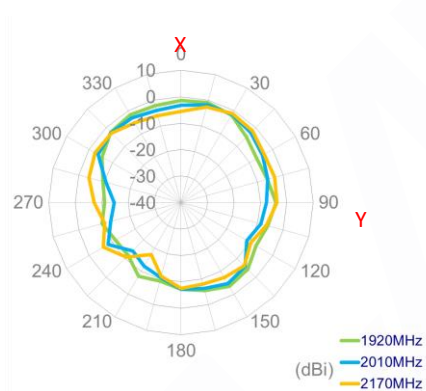

2500MHz

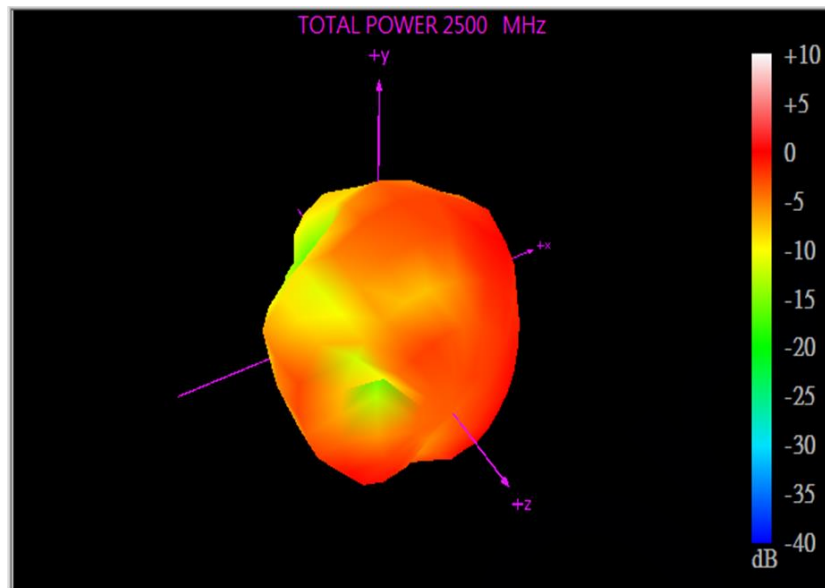

XY Plane XZ Plane YZ Plane

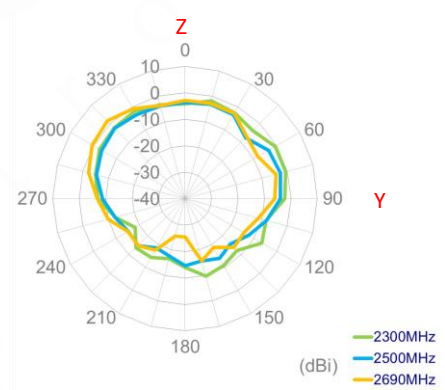
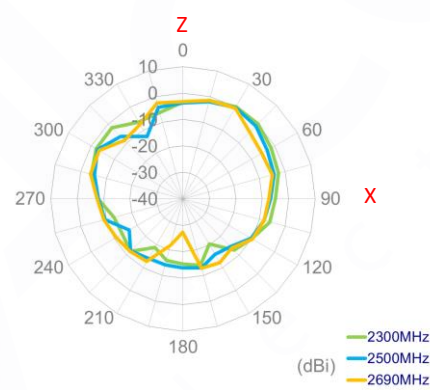
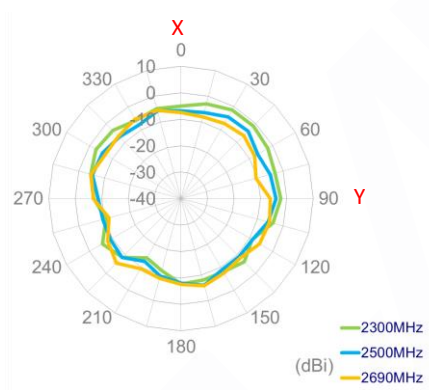

3300MHz

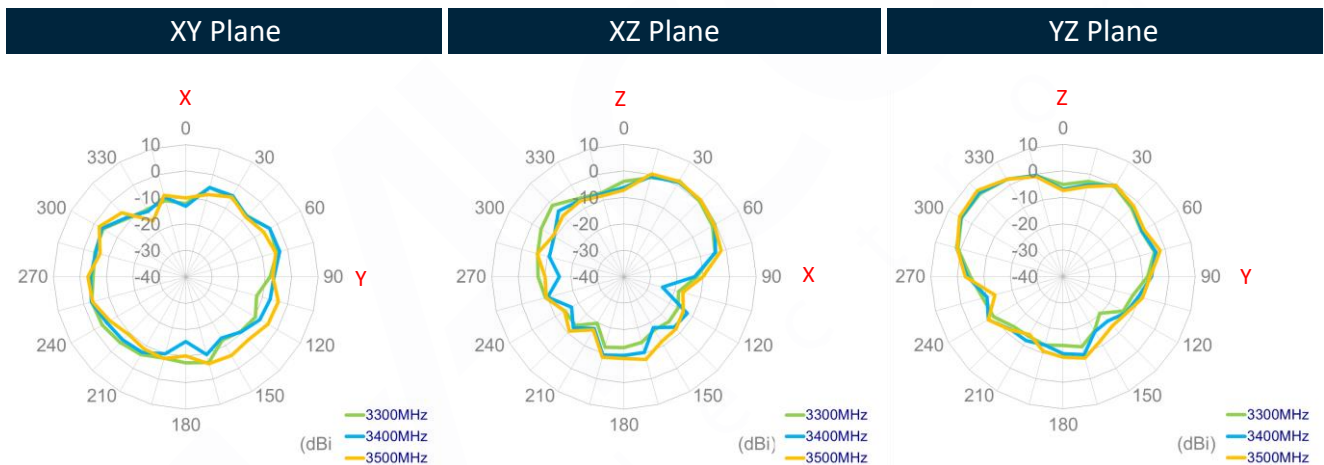
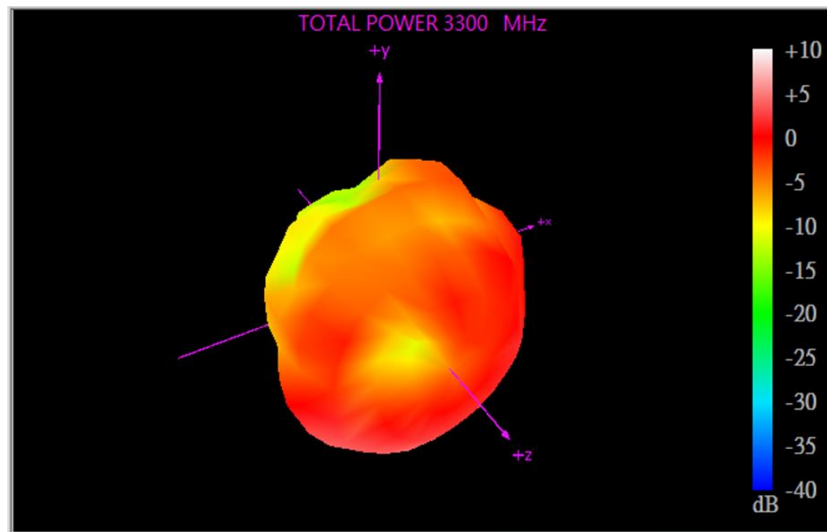

5550MHz

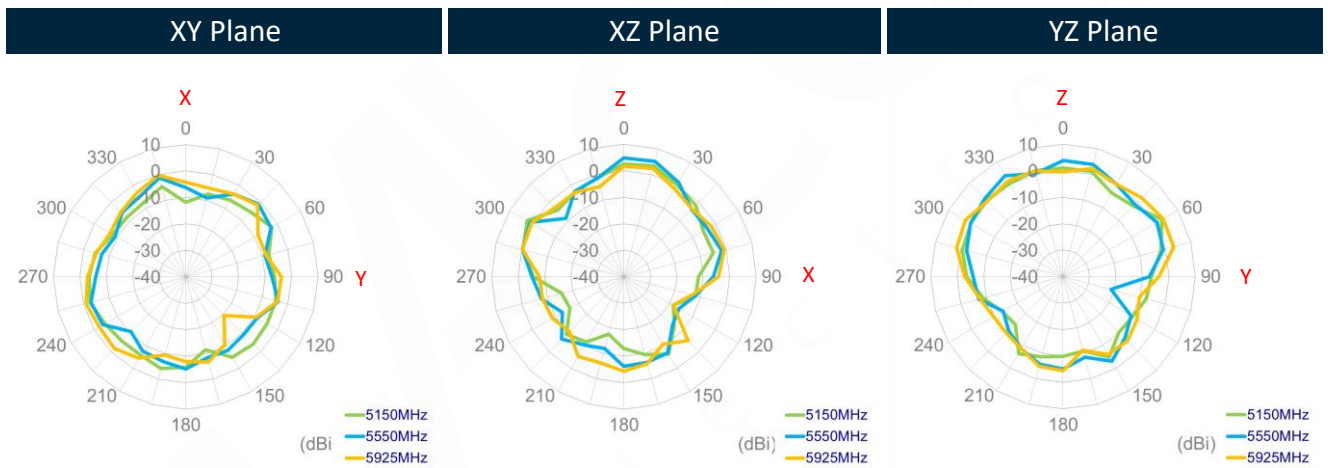
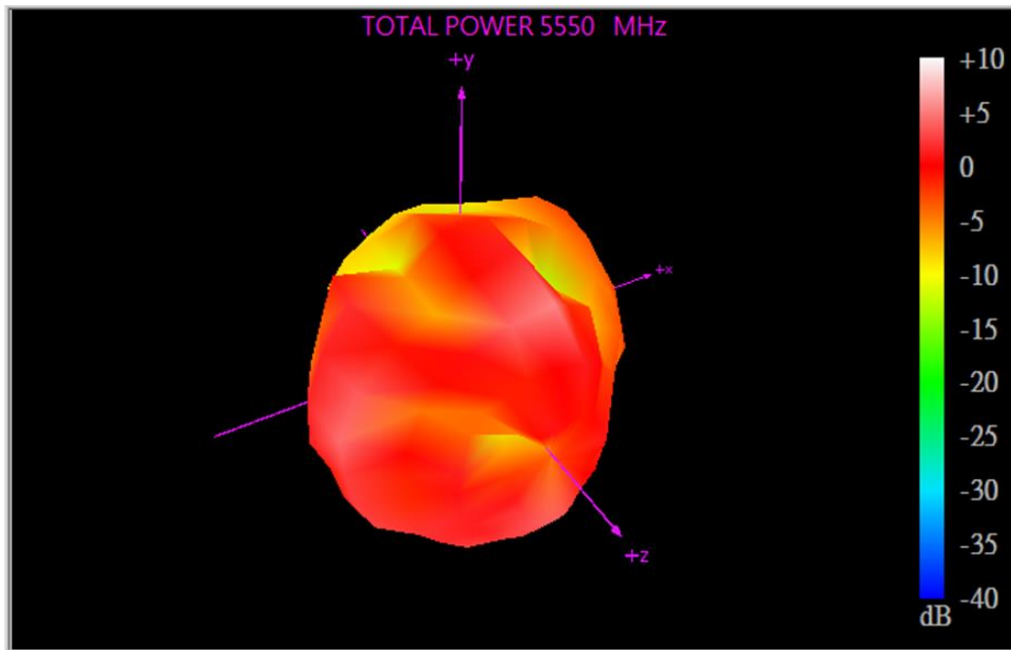

5.5 5G/4G MIMO 4 Radiation Pattern

663MHz

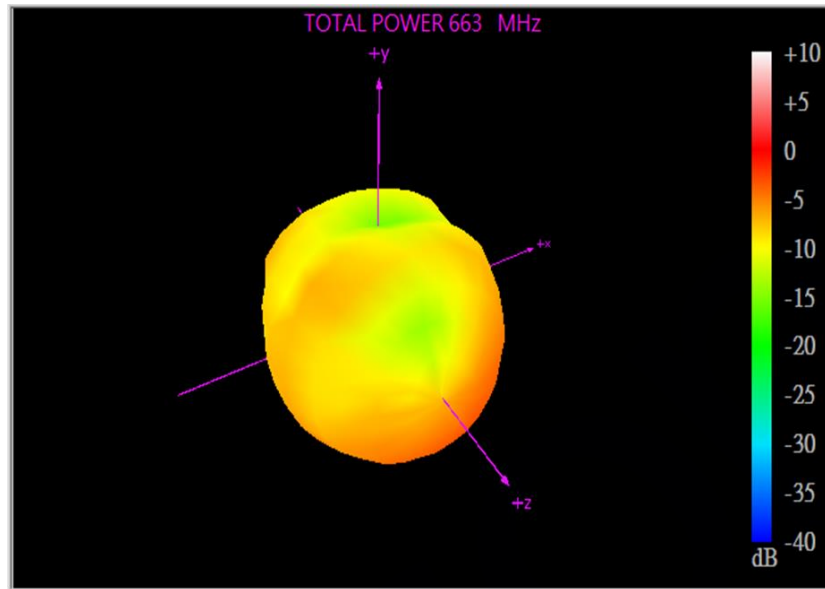

XY Plane XZ Plane YZ Plane

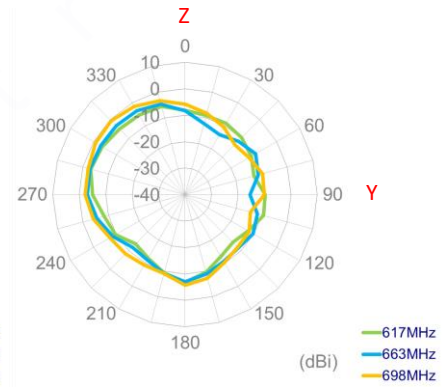
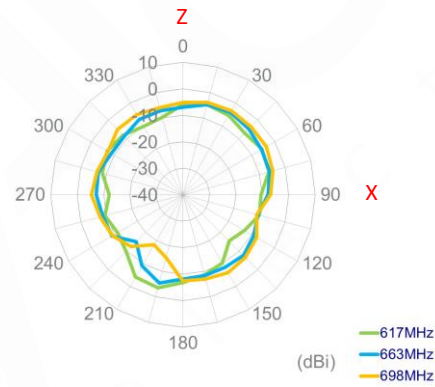
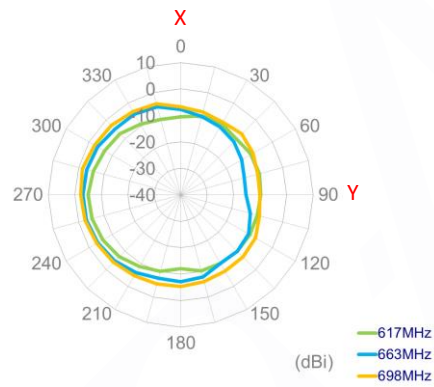

751MHz

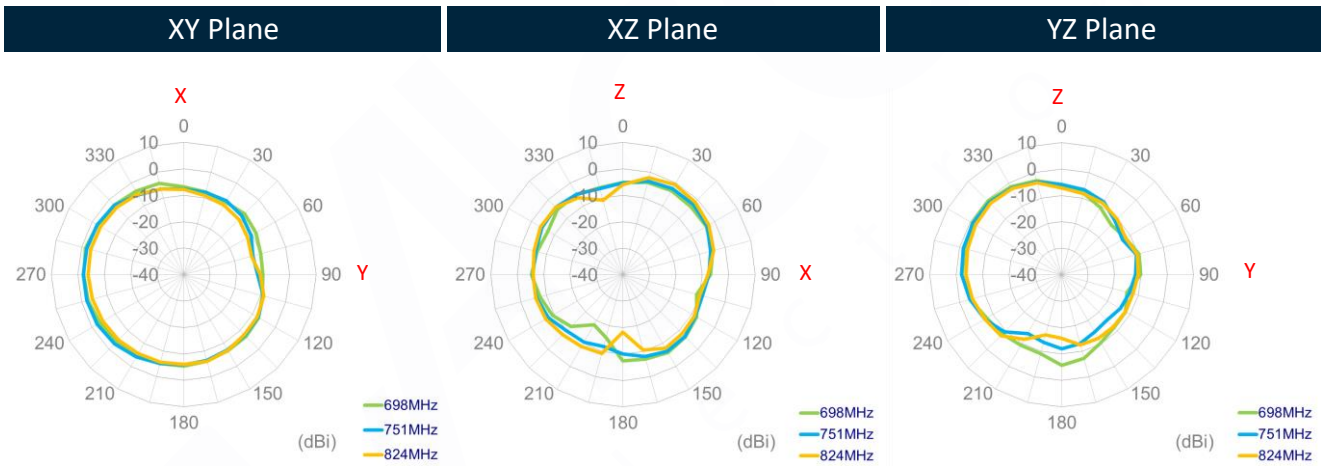
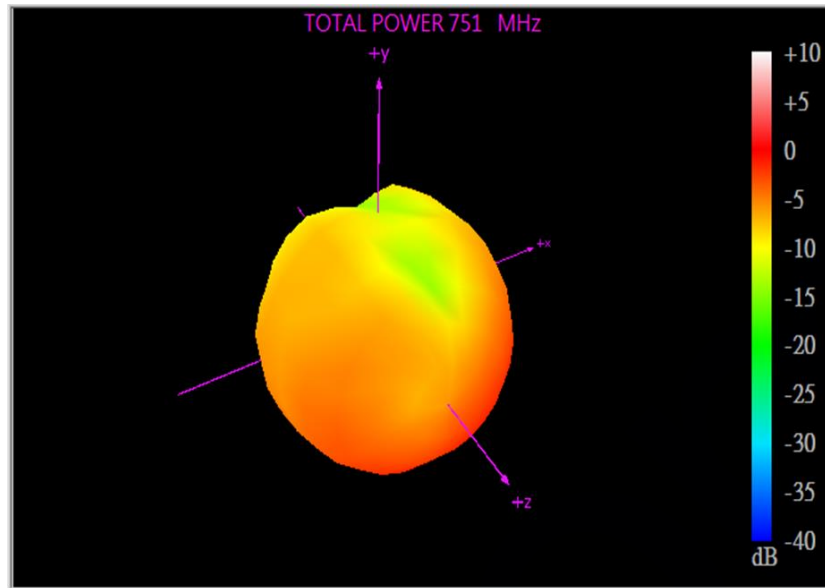

880MHz

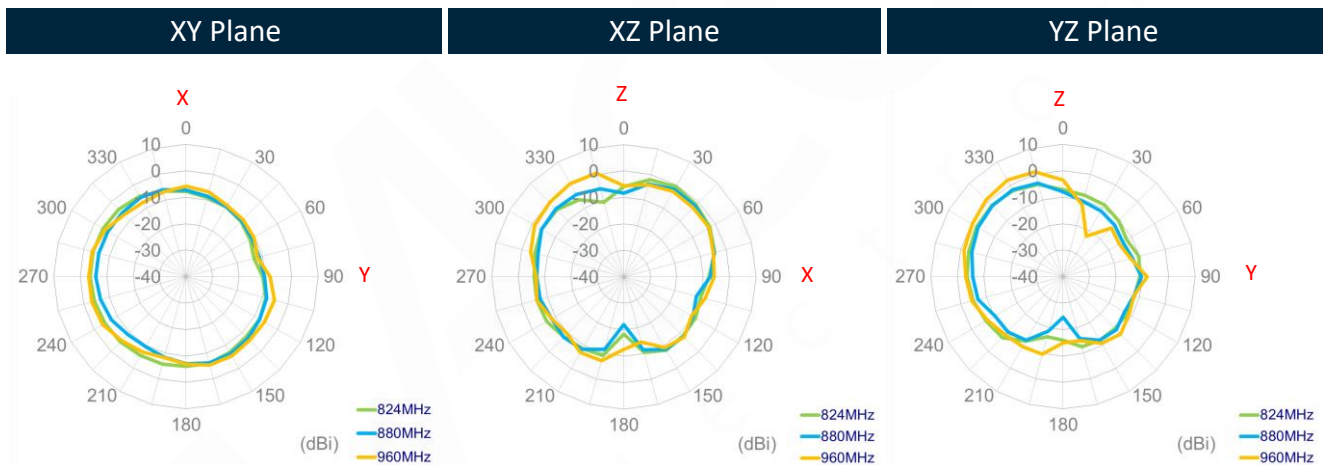
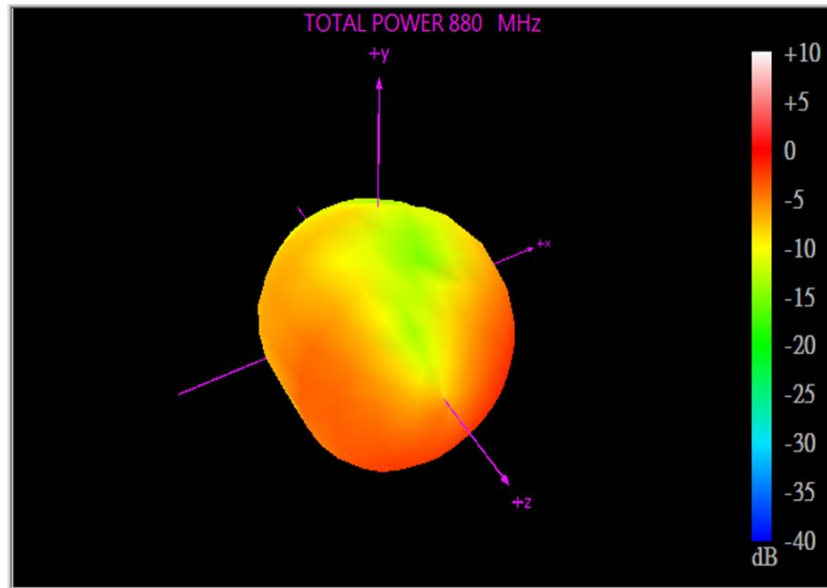

1467MHz

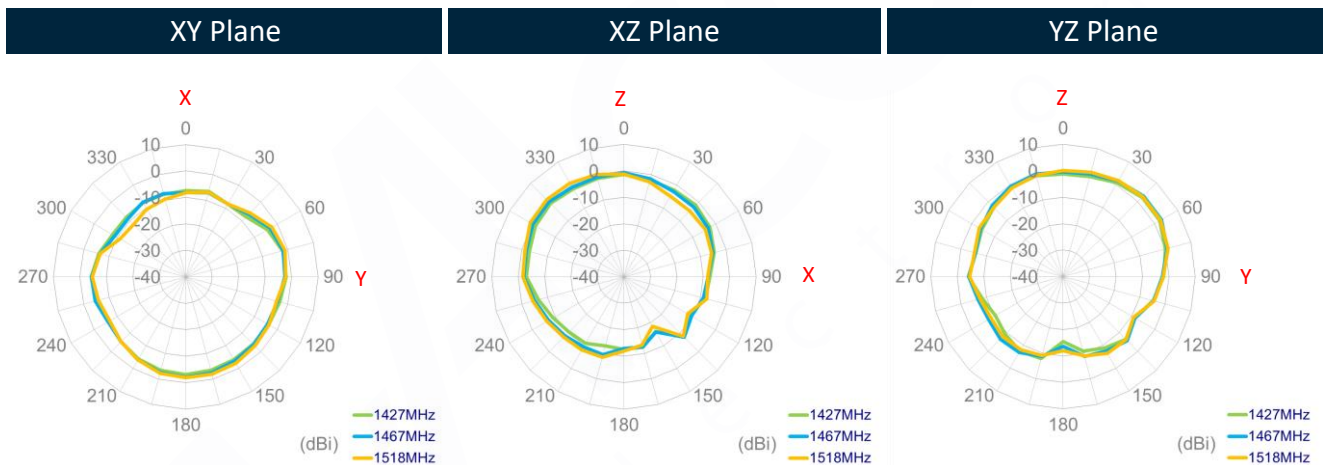
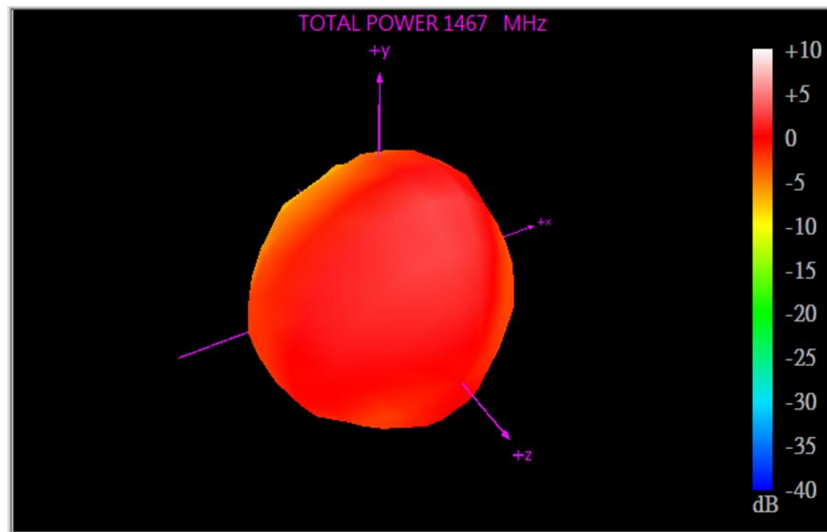

1805MHz

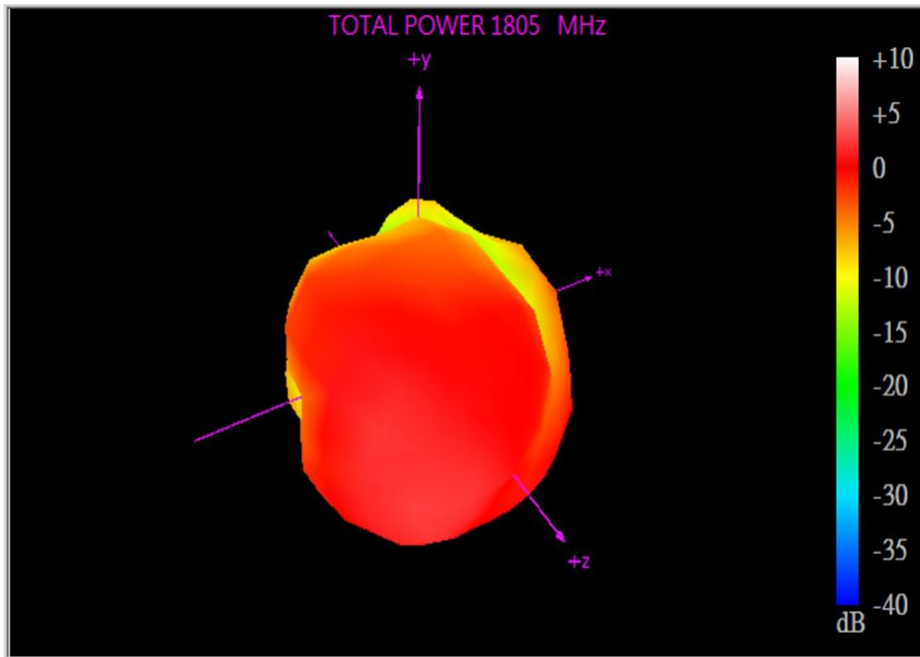

XY Plane XZ Plane YZ Plane

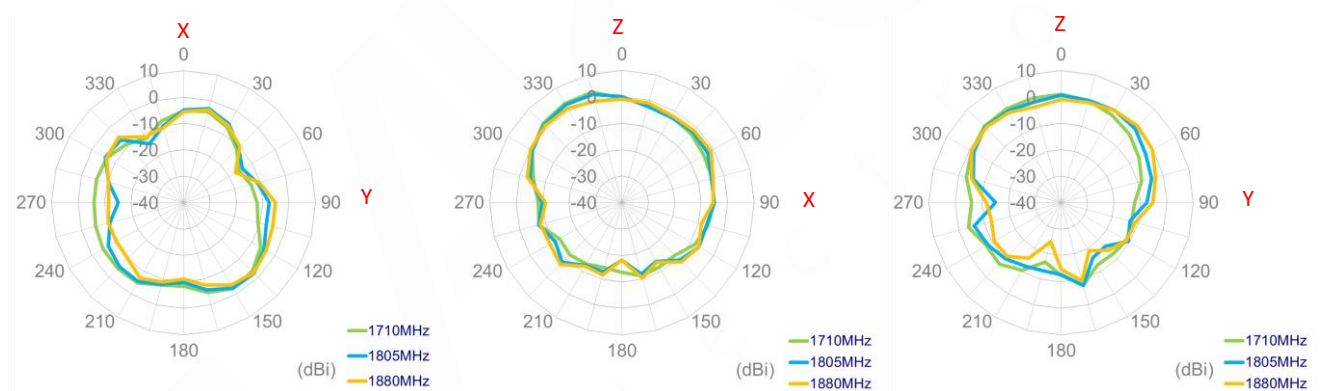

1920MHz

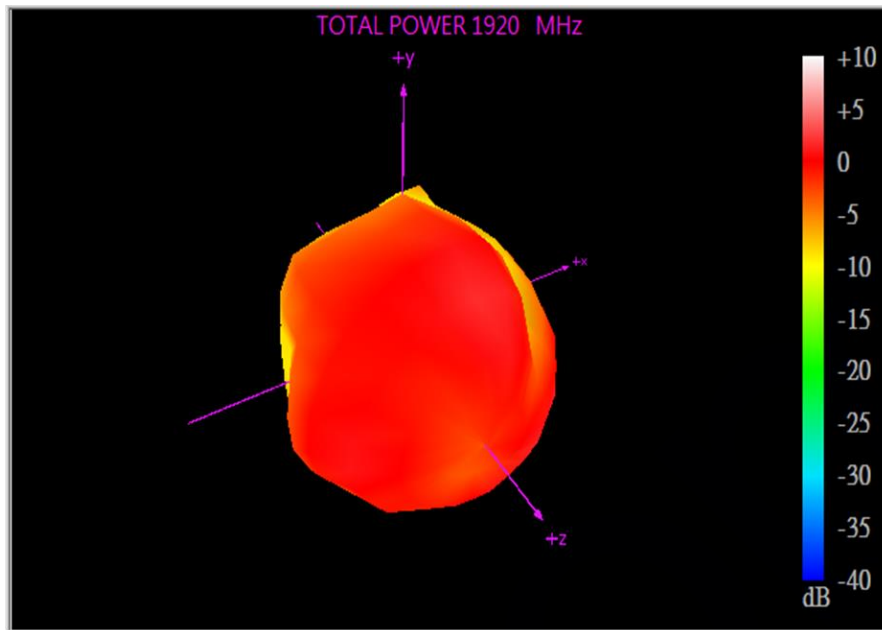

XY Plane XZ Plane YZ Plane

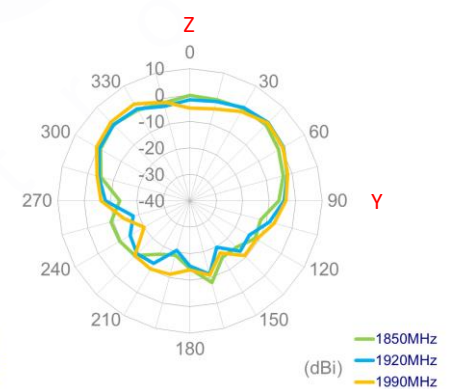
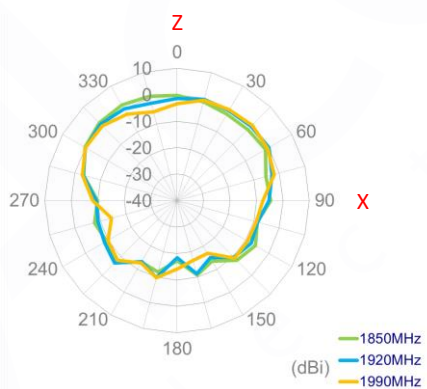
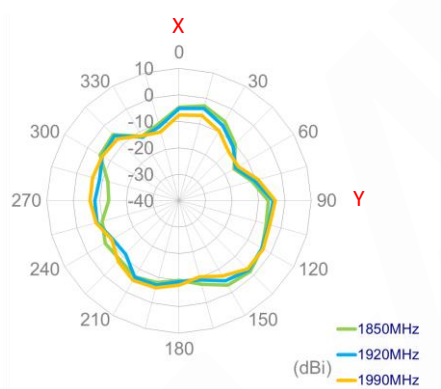

2010MHz

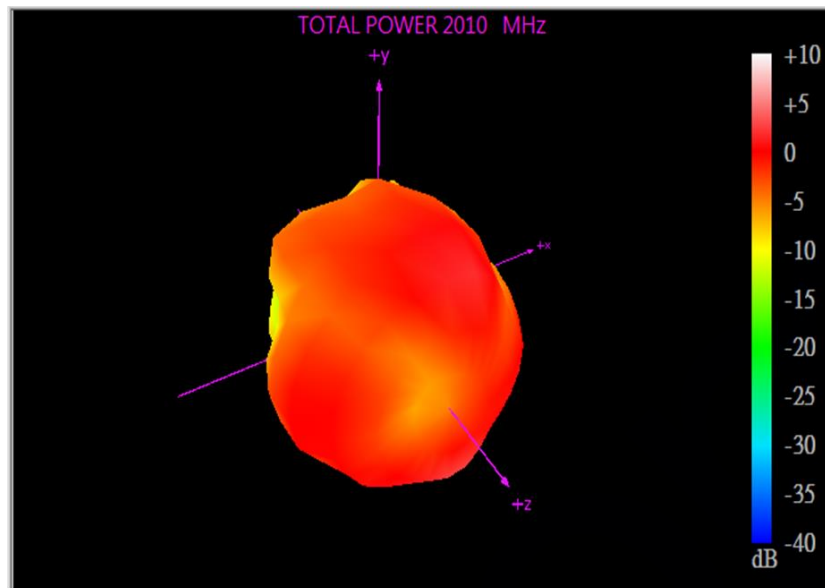

XY Plane XZ Plane YZ Plane

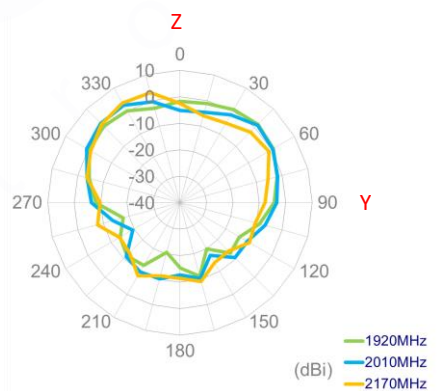
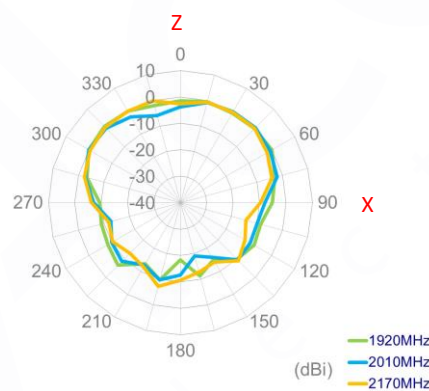
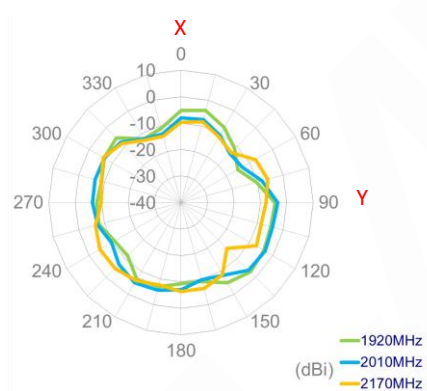

2500MHz

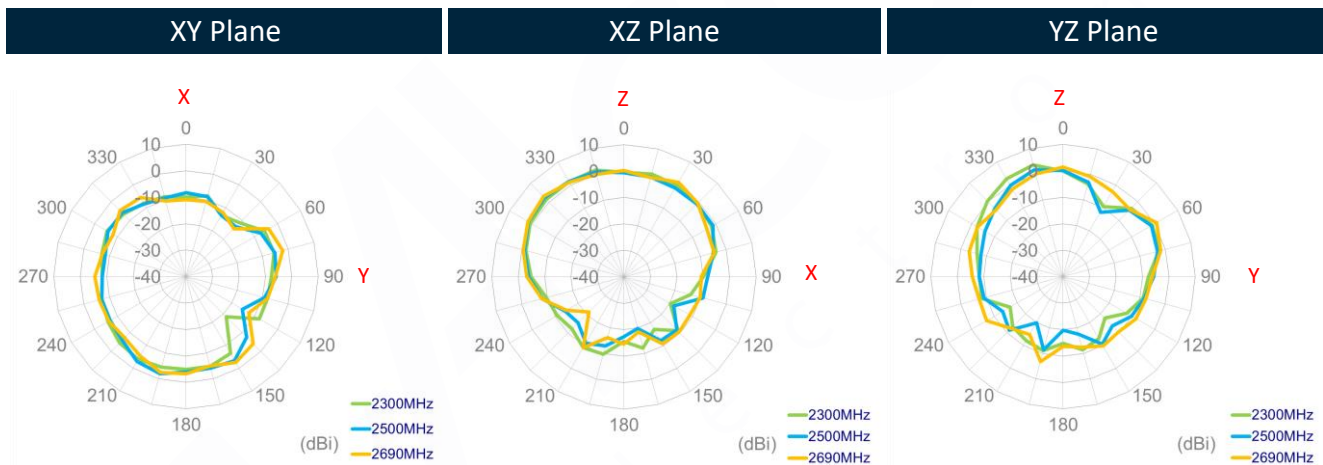
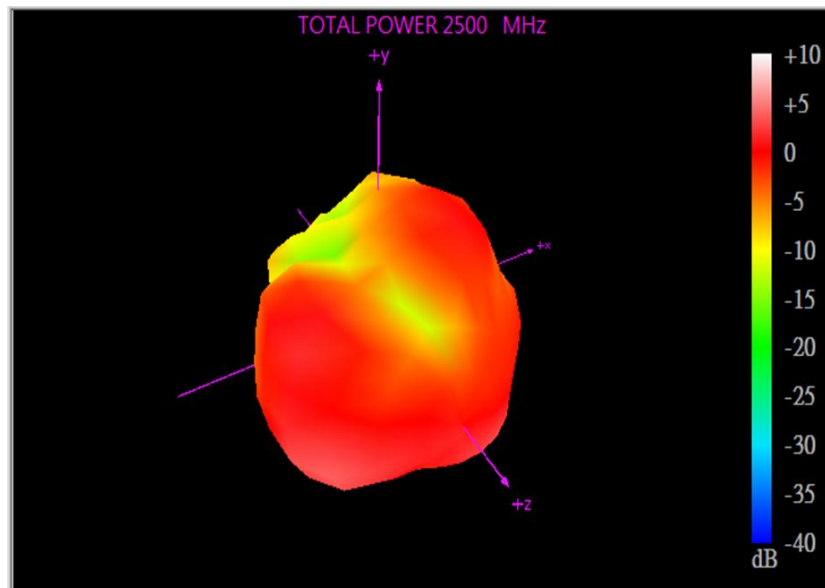

3300MHz

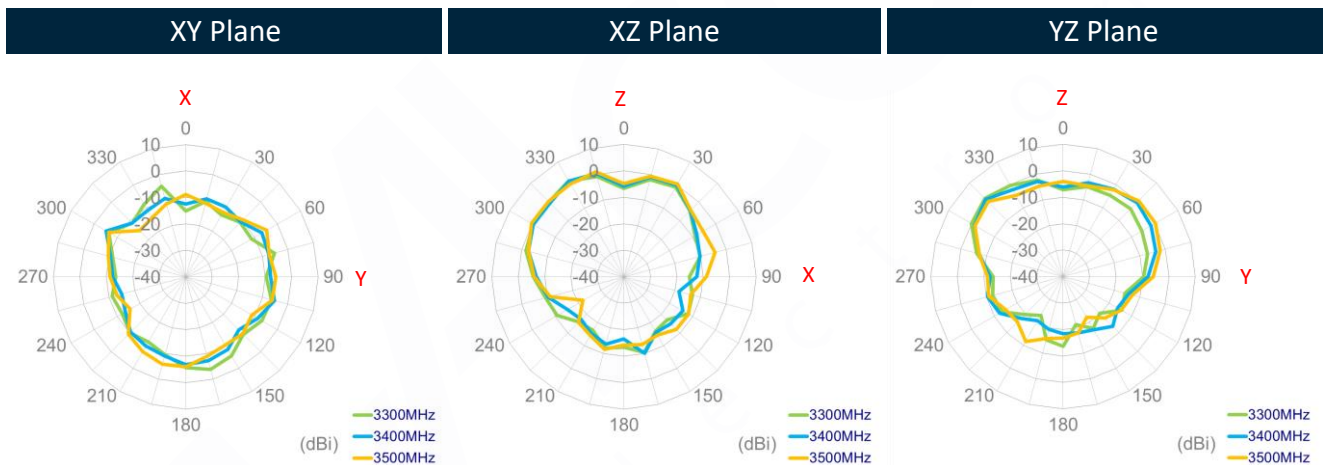
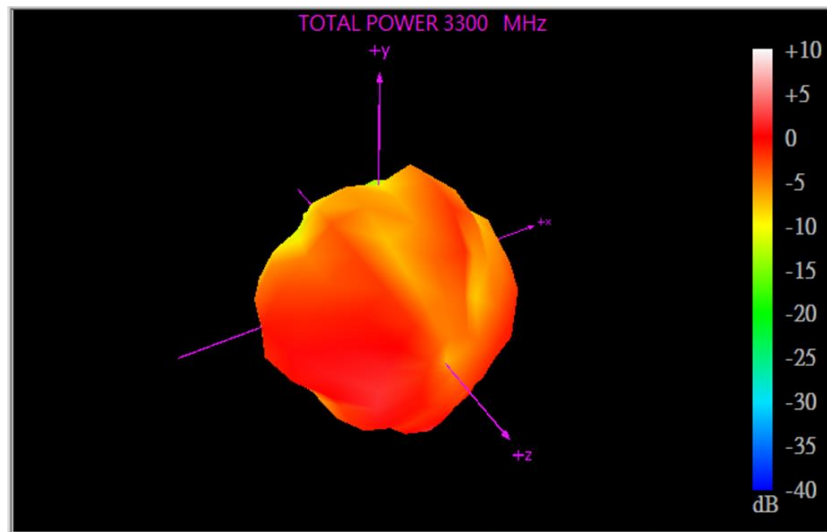

5150MHz

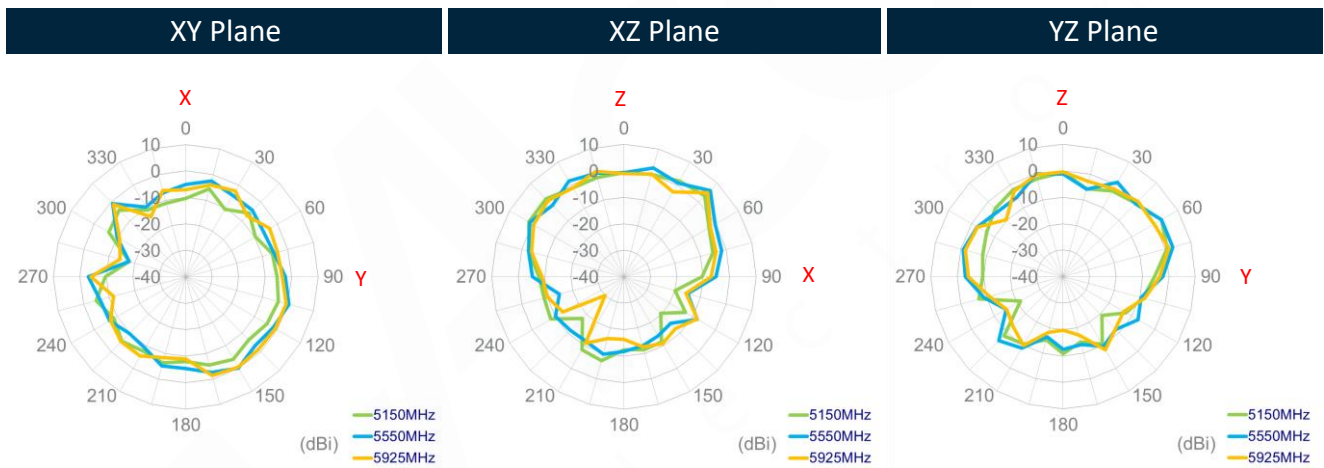
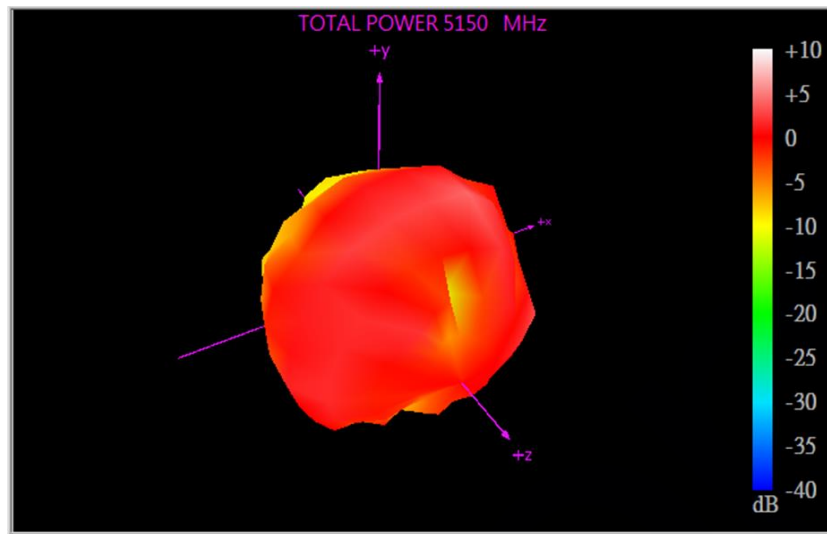

5.6 Wi-Fi MIMO 1 Radiation Pattern

2450MHz

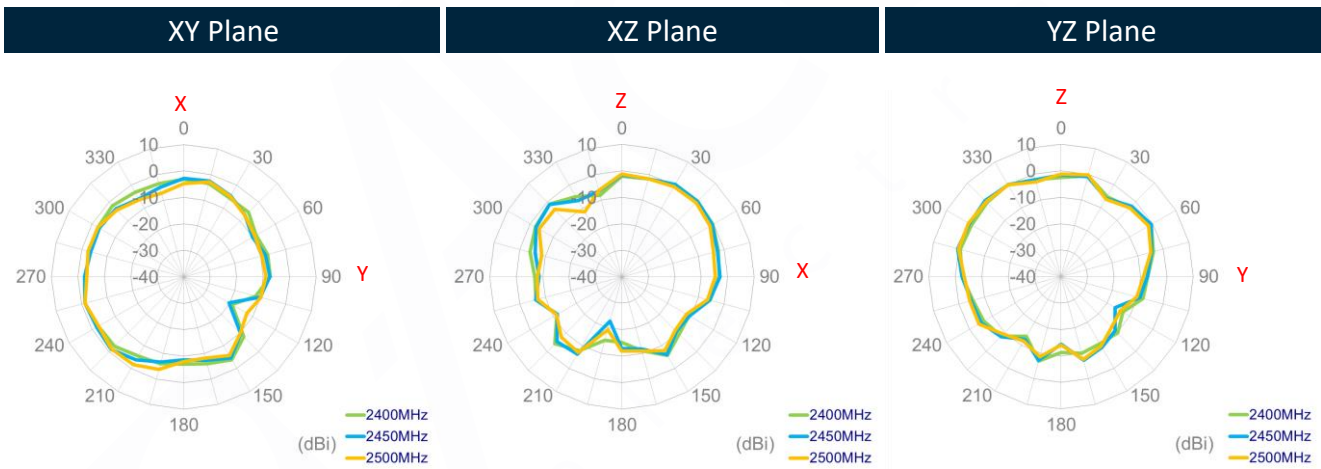
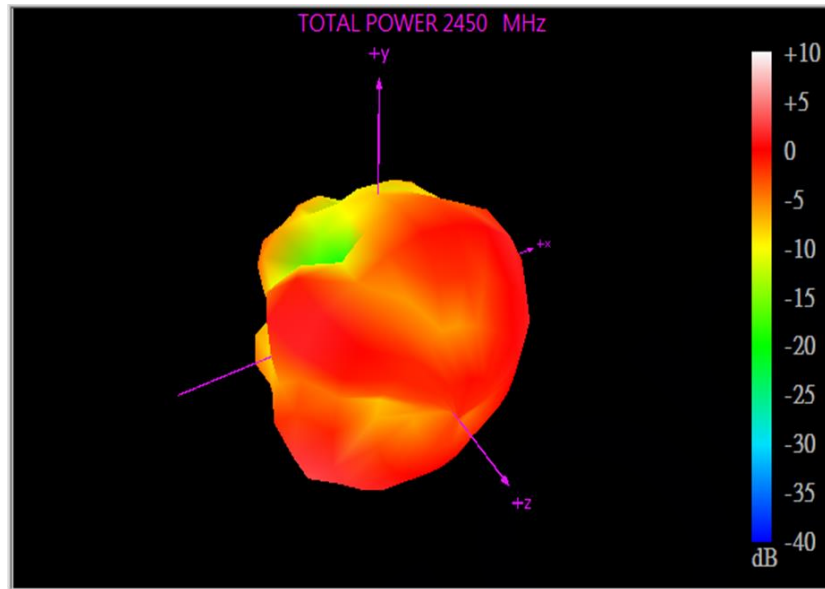

5550MHz

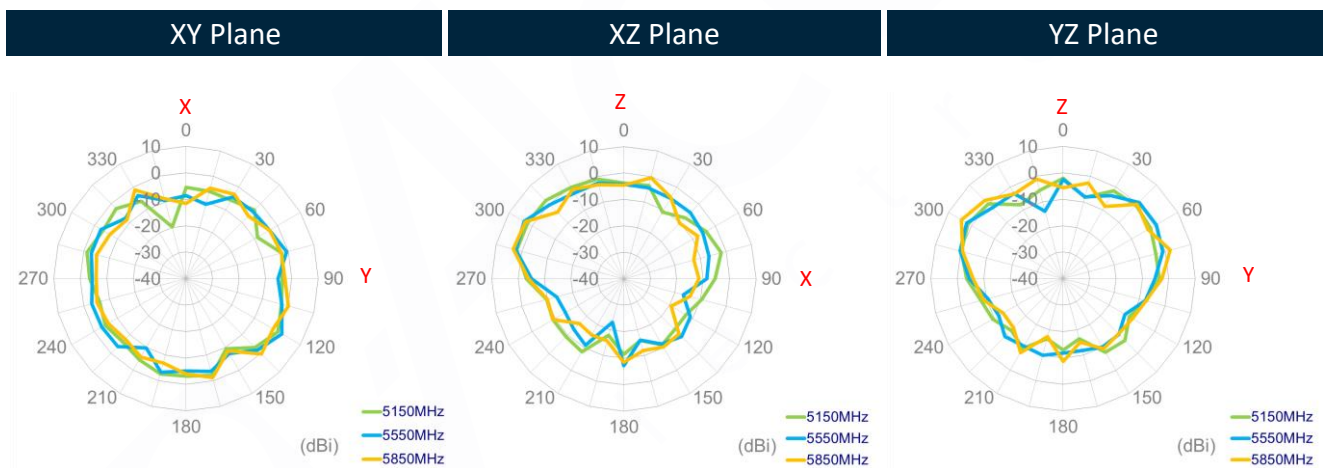
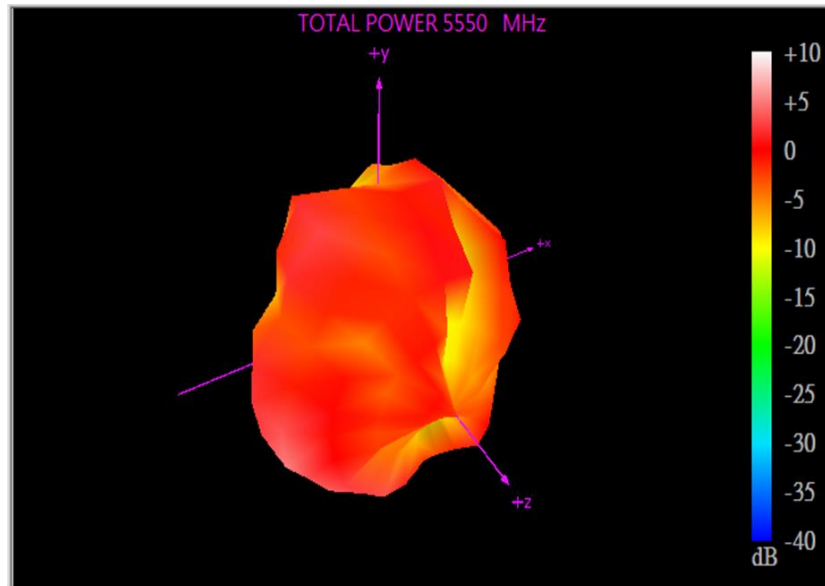

5.7 Wi-Fi MIMO 2 Radiation Pattern

2450MHz

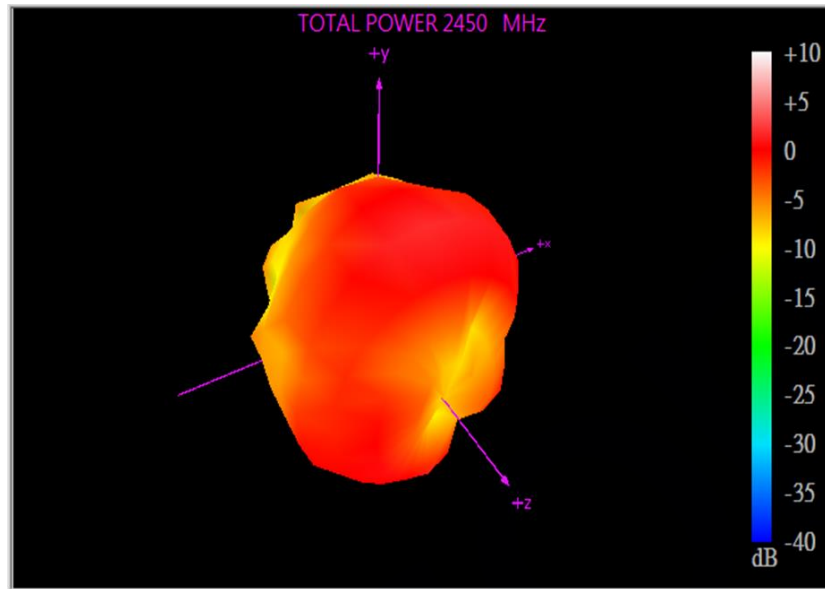

XY Plane

XZ Plane

YZ Plane

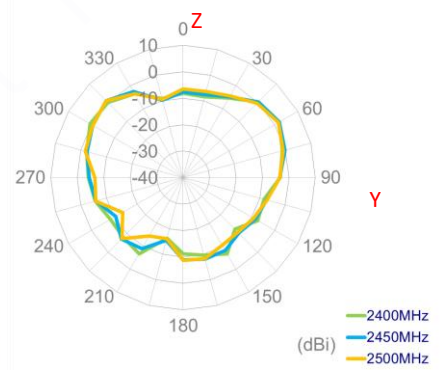
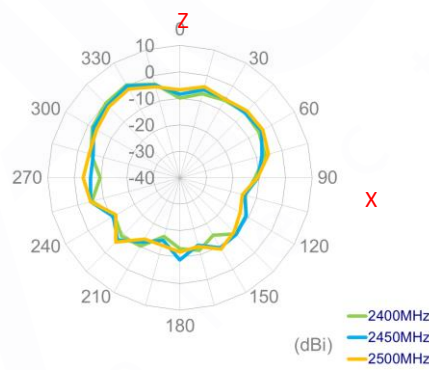
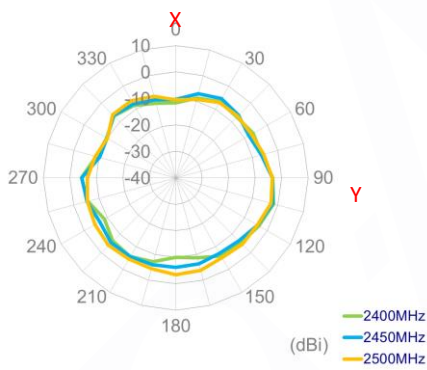

5550MHz

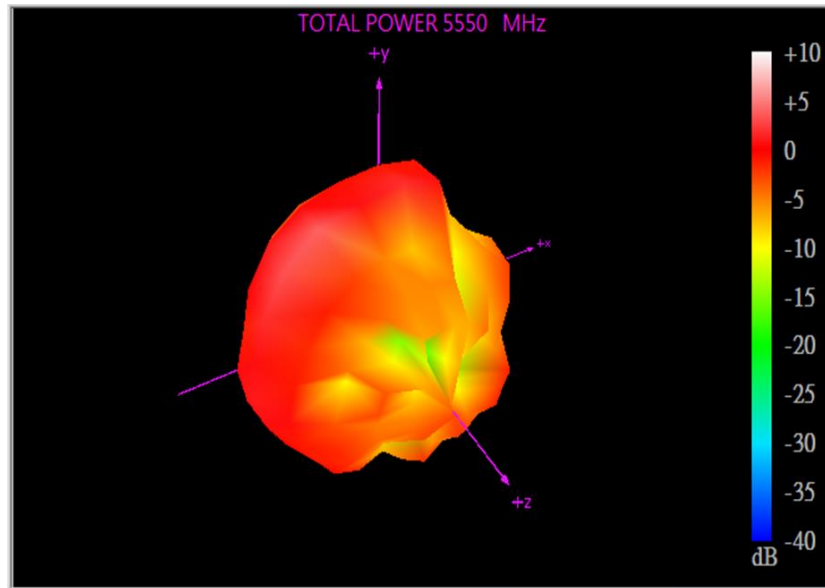

XY Plane XZ Plane YZ Plane

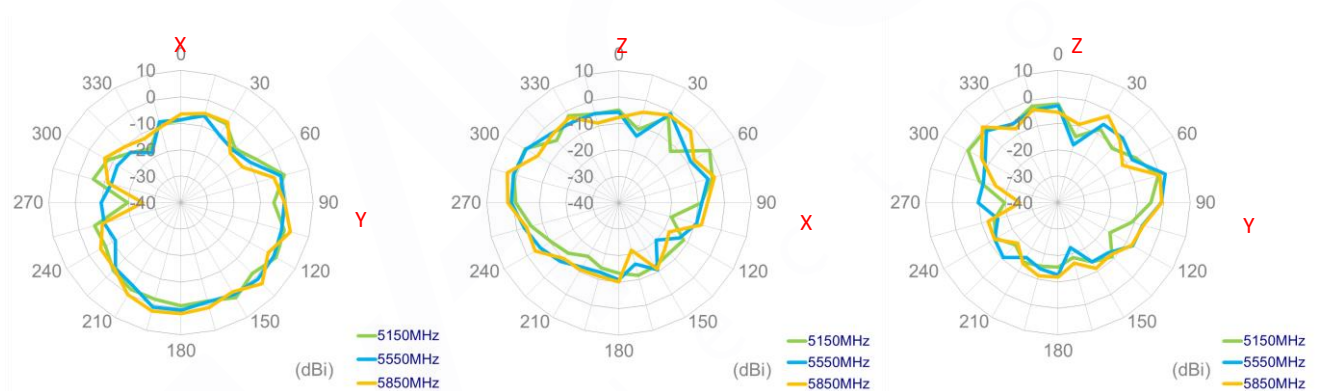

5.8 Wi-Fi MIMO 3 Radiation Pattern

2450MHz

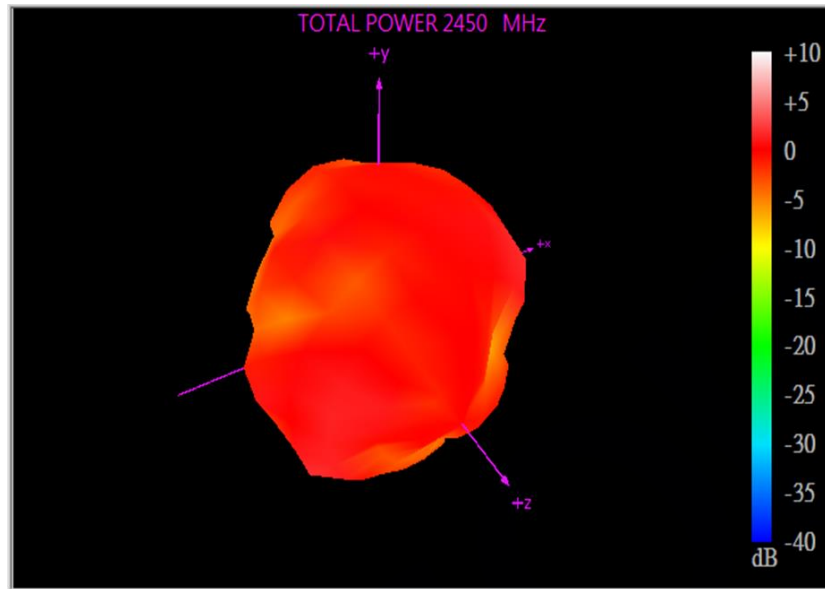

XY Plane XZ Plane YZ Plane

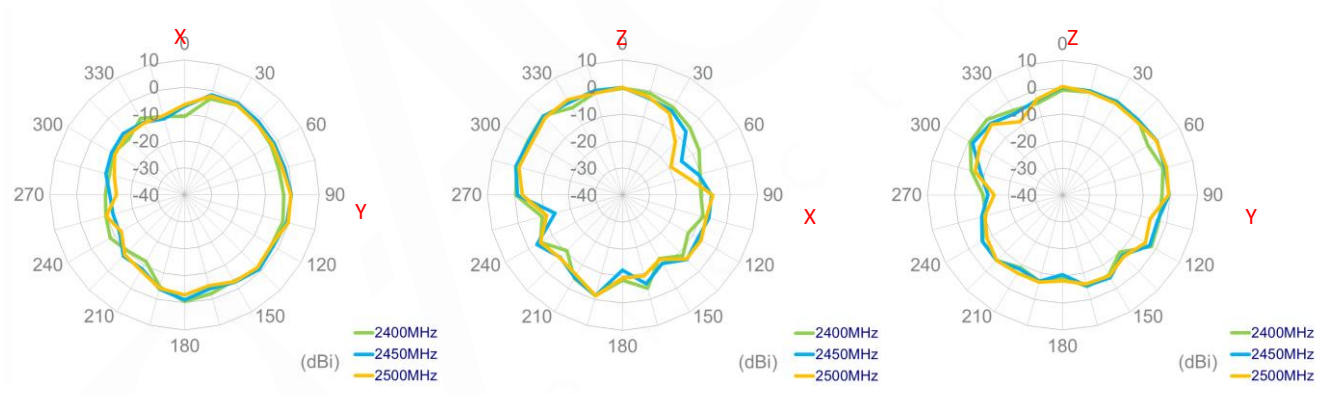

5550MHz

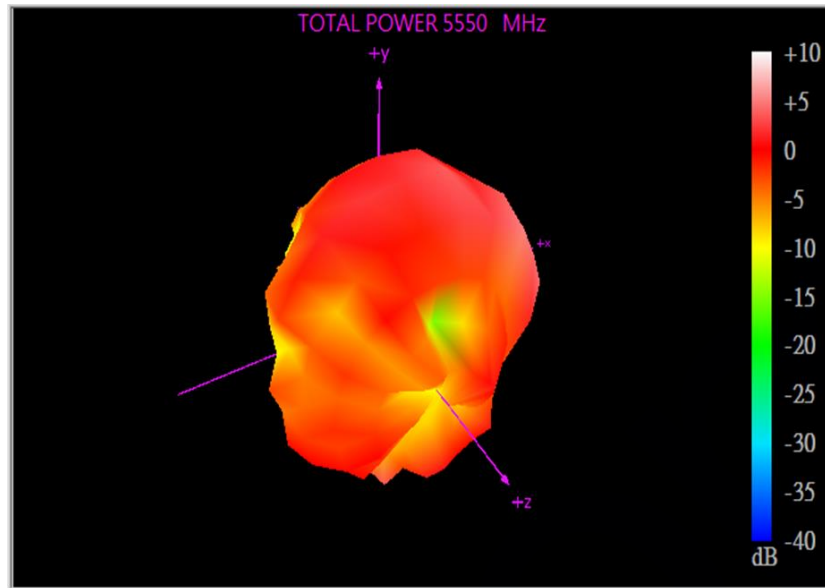

XY Plane XZ Plane YZ Plane

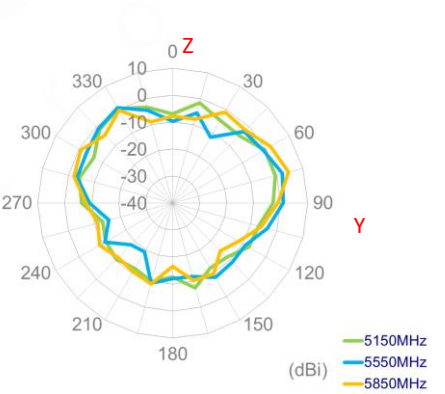
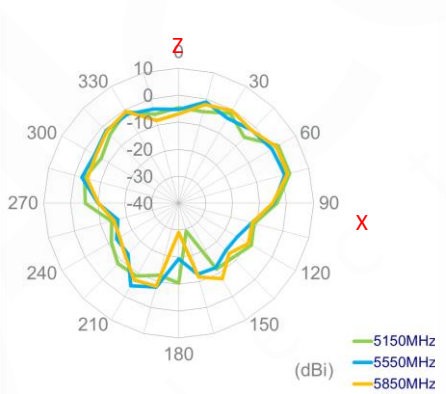
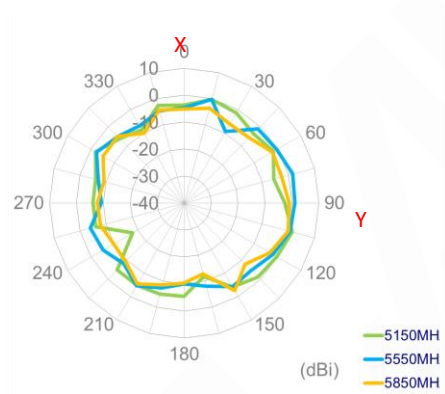

6. Mechanical Drawing (Units: mm)

ISO NO.: EDM-21-8-0571
 STATE: Release
 NOTES: 1. All material must be best compliant.

No.	Name	Material	Finish	Qty
1	Top Shell	PC	Black / Dye	1
2	Bottom Shell	PC	Black / Dye	1
3	Top Shell Gasket	PC	Black / Dye	1
4	Bottom Shell Gasket	PC	Black / Dye	1
5	Top Shell Gasket	PC	Black / Dye	1
6	Bottom Shell Gasket	PC	Black / Dye	1
7	Top Shell Gasket	PC	Black / Dye	1
8	Bottom Shell Gasket	PC	Black / Dye	1
9	Top Shell Gasket	PC	Black / Dye	1
10	Bottom Shell Gasket	PC	Black / Dye	1
11	Top Shell Gasket	PC	Black / Dye	1
12	Bottom Shell Gasket	PC	Black / Dye	1
13	Top Shell Gasket	PC	Black / Dye	1
14	Bottom Shell Gasket	PC	Black / Dye	1
15	Top Shell Gasket	PC	Black / Dye	1
16	Bottom Shell Gasket	PC	Black / Dye	1
17	Top Shell Gasket	PC	Black / Dye	1
18	Bottom Shell Gasket	PC	Black / Dye	1
19	Top Shell Gasket	PC	Black / Dye	1
20	Bottom Shell Gasket	PC	Black / Dye	1
21	Top Shell Gasket	PC	Black / Dye	1
22	Bottom Shell Gasket	PC	Black / Dye	1
23	Top Shell Gasket	PC	Black / Dye	1
24	Bottom Shell Gasket	PC	Black / Dye	1
25	Top Shell Gasket	PC	Black / Dye	1
26	Bottom Shell Gasket	PC	Black / Dye	1

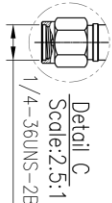
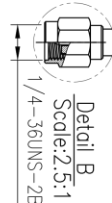
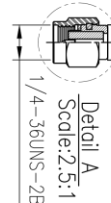
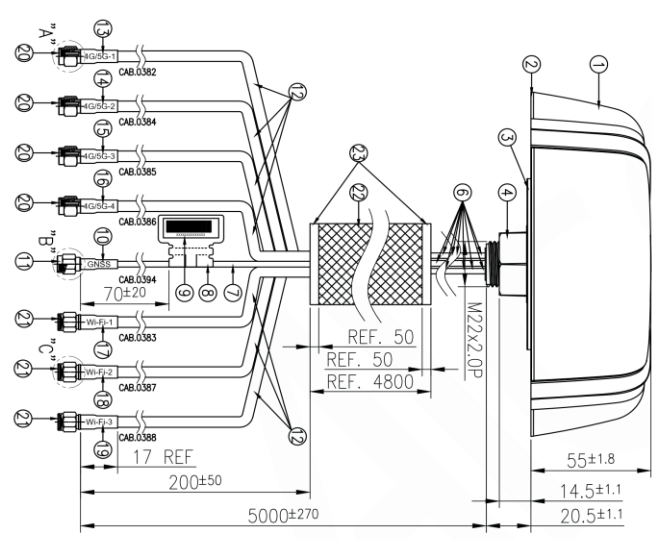
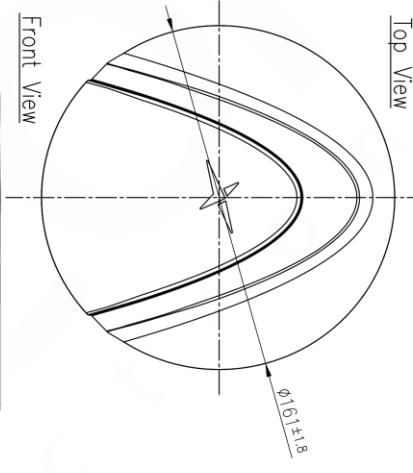

REV	AREA	DESCRIPTION	ENG.	APPROVED	DATE
01	All	Initial Design	Ruby	Aaron	2021/04/23

APPROVED BY: Aaron	DATE: 2021/04/23	TITLE: Spring 8-in-1 GNS5 SMA(M)+5G/4G SMA(M)+3W-F7
CHECKED BY: Ruby	DATE: 2021/04/23	PRJ: SMA(M) and braided cable assembly 5m TCC-200
DESIGNED BY: Ruby	DATE: 2021/04/23	PAPER NO.: MA1508.AK.001
UNIT: mm	SCALE: 1:2	PAGES: V1
REV: 001		

7. Installation Guidelines

Installation Instructions

Synergy Series

GNSS, 5G/4G and Wi-Fi Permanent Mount Combination Antenna



A Introduction

The Taoglas Synergy is an external permanent mount combination antenna. The Synergy can be provided with combinations of 5G/4G, active GNSS with front end sw and dual-band Wi-Fi. The Synergy is available with two versions of the enclosure, one designed specifically for the Ford Interceptor, both supplied with 3M adhesive, along with an M22 threaded boss for surface attachment. The Synergy is ideal for vehicle panels of up to 6mm(0.23") thick with a threaded boss length of 20.5mm(0.81"). The Synergy is IP67 rated and includes an O-Ring to seal from any water ingress.



Electrical Safety

The GPSD, SHK[G] & GPSDC contain an active GPS/GNSS antenna.
Rated voltage: 3-5VDC Rated current: 20mA maximum

The supply to this device must be provided with overcurrent protection of 1A maximum.

Power consumption@1.8V (mA) 8.7 mA

Power consumption@3.0V (mA) 9.0 mA

Power consumption@5.5V (mA) 11 mA

B Mounting & Location

For prime performance, the Synergy is recommended to be fitted on a conductive metal panel. When fitting on a non-metallic panel, a conductive metal ground plane of suitable size should be fitted underneath the mounting panel to achieve a better level of performance. Optimum ground plane size is 300mm x 300mm(11.8" x 11.8"). When mounting on a vehicle roof panel ensure to mount on a flat surface, and measure for central position. Care should be taken to mount the Synergy antenna as far as possible from other roof-mounted features such as the aircon unit, light bar etc.

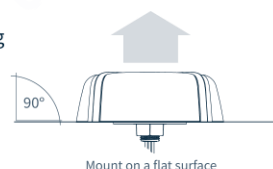

Sealing

In order to ensure that the installation is properly sealed against the mounting surface care must be taken regarding curvature of the mounting panel. It is highly recommended to install the antenna on a clean, flat and level surface. After installation the compression of the rubber boot against the mounting panel should be checked and a small bead of neutral cure silicone sealant can be applied around the periphery of the mounting boot if required.

C Mounting Hole

When preparing to drill the hole, mask the area around the hole position to protect the surface. Drill a pilot hole and increase the hole size to 24mm(7/8") dia. Ensure the drill bit does not contact the headliner. Deburr and clean the area around the hole carefully removing all waste.

Remove paint and primer from under panel surface to ensure adequate earth contact by washer and nut. Apply petroleum jelly or paint around cut edge of the hole to prevent corrosion



D Installation of the Antenna

Peel away the 3M adhesive protective and feed the cables through the hole. Position the antenna over the hole and press down onto the panel with pressure. A split nut is used to easily fit onto the thread through the cables. The nut is attached from the underside of the panel, it should easily twist onto the thread and only a final tighten by spanner is required.

E Routing and Connection of the Cables

The Cables supplied are RG-174 for the GNSS feed and TGC-200 for the other feeds. The heatshrink will denote which cable is which for ease of installation. Connect each individual connector to the correct port of the router, if any cable is unused please fit a 50Ω terminator to the individual connection.

G Notices



Caution

To comply with FCC RF Exposure requirements in section 1.1310 of the FCC Rules, antennas used with this device must be installed to provide a separation distance of at least 20 cm from all persons to satisfy RF exposure compliance.



Warning

Do not Operate the transmitter when someone is within 20 cm of the antenna.
Do not operate the equipment in an explosive atmosphere.



European Waste Electronic Equipment Directive 2002/96/EC

Please ensure that your old Waste Electricals and Electronics are recycled do not throw them away into standard waste.



Directive 2014/53/EU Radio Equipment Directive (RED)

Harmonised Standards and References:

EN 301 489-1 (V2.2.1): ElectroMagnetic Compatibility (EMC) standard for radio equipment and services; Part 1: Common technical requirements. Referencing CENELEC EN 55032 Class B.

Waiver: This document represents information compiled by Taoglas to the best of our current knowledge. This is not intended to be used as a representation or warranty of fitness of the products described for any particular purpose. This document details guidelines for general information purposes only. When planning installations, always seek specialist advice and ensure that the products are always installed by a properly qualified installer in accordance with applicable regional laws and regulations.

All copyrights, trademarks and any other intellectual property rights related are owned by Taoglas Group Holdings Limited.

8. Packaging



1pc MA1508.AK.001 per PE Bag
Weight: 2.5Kg

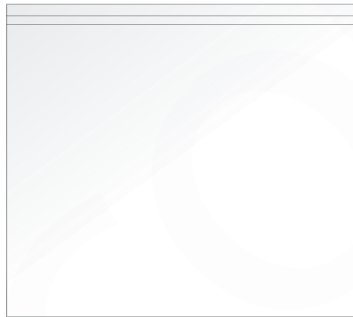

4pcs MA1508.AK.001 per Carton
Carton Dimensions: 740*370*300mm
Weight: 10.4Kg

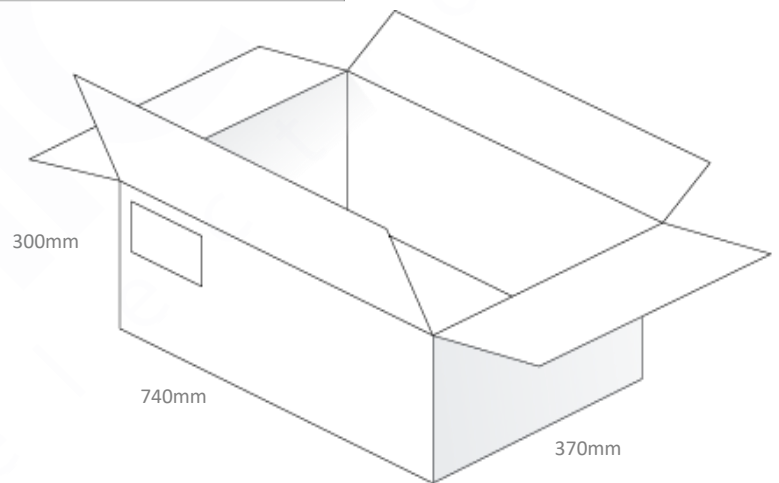

Changelog for the datasheet

SPE-20-8-031 - MA1508.AK.001

Revision: A (Original First Release)

Date:	2021-04-23
Notes:	Initial Release
Author:	Jack Conroy

Previous Revisions



TAOGLAS®

www.taoglas.com

