



TAOGLAS®

Datasheet

Taoglas Invisible Antenna™

Part No:
TFX62.A

Description

TFX62.A - Cellular Invisible Antenna

Features:

- 600-6000MHz
- Worldwide 5G/4G Bands
- Efficiencies up to 60%
- Transparent Ultra Low Profile
- Dims: 110mm * 160mm
- Connector: FAKRA D (M) Violet
- RoHS & Reach Compliant



Singel 3 | B-2550 Kontich | Belgium | Tel. +32 (0)3 458 30 33
 info@alcom.be | www.alcom.be
 Rivium 1e straat 52 | 2909 LE Capelle aan den IJssel | The Netherlands
 Tel. +31 (0)10 288 25 00 | info@alcom.nl | www.alcom.nl

1.	Introduction	2
2.	Specification	3
3.	Antenna Characteristics	5
4.	Radiation Patterns	8
5.	Mechanical Drawing	17
6.	Packaging	18
<hr/>		
	Changelog	19

Taoglas makes no warranties based on the accuracy or completeness of the contents of this document and reserves the right to make changes to specifications and product descriptions at any time without notice. Taoglas reserves all rights to this document and the information contained herein. Reproduction, use or disclosure to third parties without express permission is strictly prohibited.



1. Introduction



The TFX62 is a first of its kind, invisible antenna designed to cover worldwide 4G bands from 690-3000MHz. The TFX62 has been expertly engineered by Taoglas with innovation in mind, the design is based on our excellent design history in pioneering flexible PCB antenna technology. TFX62 is supplied with pre adhered adhesive for ease of installation and has an enclosed carrier terminated with a FAKRA connector.

The transparent flexible antennas are an alternative to standard Flexible PCB antennas where the user may want to install an antenna in a covert area or on a surface, they may want to keep visible. The performance of the antenna is based on the environment where it is placed, care should be taken to mount at least 20mm from metal components where possible.

Typical Applications Include:

- Automotive and Commercial Transportation
- EV Charging and Parking Bays
- Digital Signage and Display screens
- Point Of Sale Kiosks

The installation of the TFX series follows a similar installation method to flexible PCB antennas, as detailed in this application note [APN-11-8-004.C.pdf \(taoglas.com\)](#). As installing a transparent material may show obvious flaws/debris, take care to wipe the area clean before adhering the antenna. The flexible antenna can be disconnected from the body to make installation easier. Where support may be an issue, we would advise using a double-sided adhesive on the housing to ensure the housing body installation does not add any additional pull force to the antenna as this will affect the antennas performance and the adhesive's performance. The feed is not designed to be load bearing and loads of over 0.5Kg can break or damage the feed resulting in the antenna disconnecting.

The TFX62 is connected via a FAKRA Code D male connector for ease of installation. If a custom connector is required please contact your regional Taoglas customer support team.

2. Specification

LTE Electrical								
Band	Frequency (MHz)	Efficiency (%)	Average Gain (dB)	Peak Gain (dBi)	Impedance	Polarization	Radiation Pattern	Max. input power
5GNR/4G Band71	617-698	16.9	-7.71	-2.40	50 Ω	Linear	Omni	2W
4G/3G Band 12,13,14,17,28,29	698-806	21.9	-6.59	-1.33				
4G/3G/NB-IoT/Cat M Band 5,8,18,19,20,26,27	824-960	42.5	-3.71	0.99				
5GNR/4G Band 21,32,74,75,76	1427-1518	39.2	-4.07	1.58				
4G/3G Band 1,2,3,4,9,23,25,35,39,66	1710-2200	47.1	-3.27	2.23				
4G/3G Band 7,30,38,40,41	2300-2690	55.5	-2.56	4.65				
5GNR/4G Band 22,42,48,77,78,79	3300-5000	46.1	-3.36	4.54				
LTE5200/Wi-Fi5800	5150-5925	27.4	-5.63	3.67				

Mechanical	
Dimensions	110 x 160mm
Weight	5g
Material (Housing)	ABS/PC
Material (Antenna)	PET
Connector	Code D FAKRA (M) Violet

Environmental	
Operation Temperature	-40°C to 85°C
Storage Temperature	-40°C to 85°C

5G/4G Bands			
Band Number	5GNR / FR1 / LTE / LTE-Advanced / WCDMA / HSPA / HSPA+ / TD-SCDMA		
	Uplink	Downlink	Covered
B1	1920 to 1980	2110 to 2170	✓
B2	1850 to 1910	1930 to 1990	✓
B3	1710 to 1785	1805 to 1880	✓
B4	1710 to 1755	2110 to 2155	✓
B5	824 to 849	869 to 894	✓
B7	2500 to 2570	2620 to 2690	✓
B8	880 to 915	925 to 960	✓
B9*	1749.9 to 1784.9	1844.9 to 1879.9	✓
B11	1427.9 to 1447.9	1475.9 to 1495.9	✓
B12	699 to 716	729 to 746	✗
B13	777 to 787	746 to 756	✓
B14	788 to 798	758 to 768	✓
B17	704 to 716	734 to 746	✗
B18	815 to 830	860 to 875	✓
B19	830 to 845	875 to 890	✓
B20	832 to 862	791 to 821	✓
B21	1447.9 to 1462.9	1495.9 to 1510.9	✓
B22*	3410 to 3490	3510 to 3590	✓
B23*	2000 to 2020	2180 to 2200	✓
B24	1626.5 to 1660.5	1525 to 1559	✓
B25	1850 to 1915	1930 to 1995	✓
B26	814 to 849	859 to 894	✓
B27*	807 to 824	852 to 869	✓
B28	703 to 748	758 to 803	✓
B29		717 to 728	✓
B30	2305 to 2315	2350 to 2360	✓
B31	452.5 to 457.5	462.5 to 467.5	✗
B32		1452 to 1496	✓
B34		2010 to 2025	✓
B35		1850 to 1910	✓
B36		1930 to 1990	✓
B37		1910 to 1930	✓
B38		2570 to 2620	✓
B39		1880 to 1920	✓
B40		2300 to 2400	✓
B41		2496 to 2690	✓
B42		3400 to 3600	✓
B43		3600 to 3800	✓
B45		1447 to 1467	✓
B46		5150 to 5925	✓
B47		5855 to 5925	✓
B48		3550 to 3700	✓
B49		3550 to 3700	✓
B50		1432 to 1517	✓
B51		1427 to 1432	✓
B52		3300 to 3400	✓
B53		2483.5 to 2495	✓
B65	1920 to 2010	2110 to 2200	✓
B66	1710 to 1780	2110 to 2200	✓
B68	698 to 728	753 to 783	✓
B69		2570 to 2620	✓
B70	1695 to 1710	1995 to 2020	✓
B71	663 to 698	617 to 652	✓
B72	451 to 456	461 to 466	✗
B73	450 to 455	460 to 465	✗
B74	1427 to 1470	1475 to 1518	✓
B75		1432 to 1517	✓
B76		1427 to 1432	✓
B77		3300 to 4200	✓
B78		3300 to 3800	✓
B79		4400 to 5000	✓
B85	698 to 716	728 to 746	✓
B87	410 to 415	420 to 425	✗
B88	412 to 417	422 to 427	✗

3. Antenna Characteristics

3.1 Return Loss

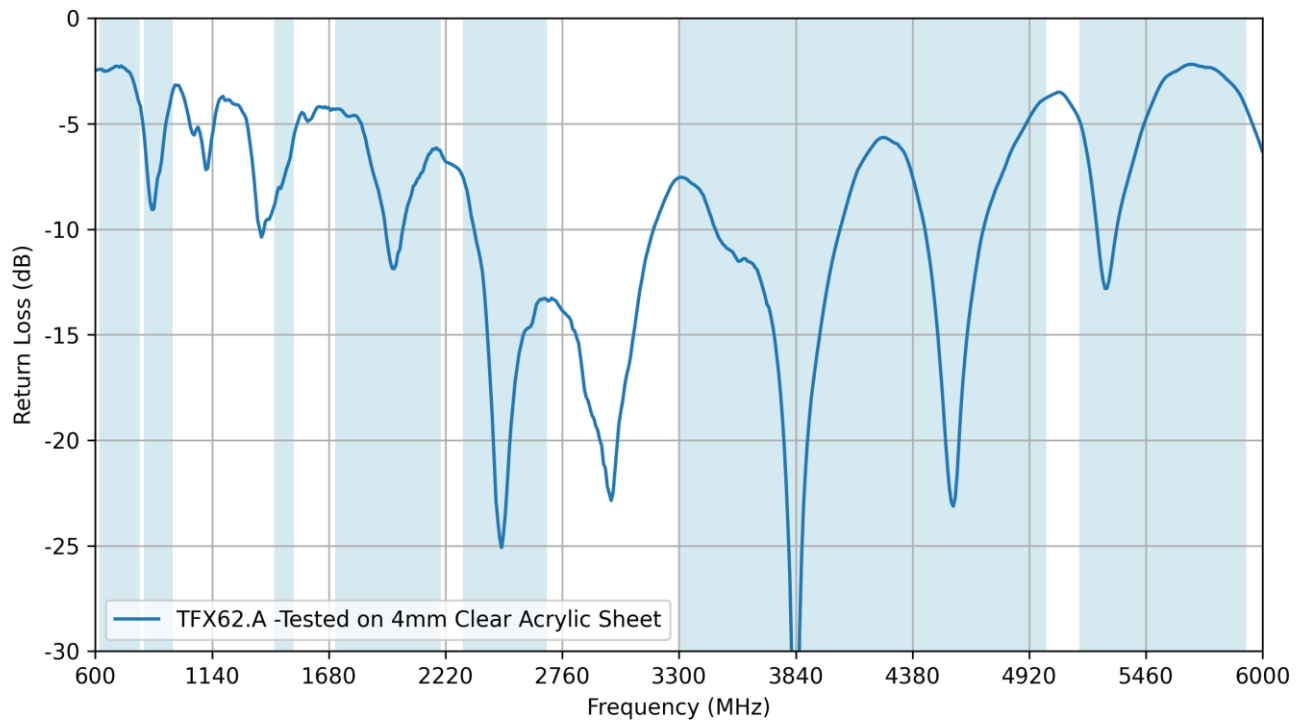

3.2 VSWR

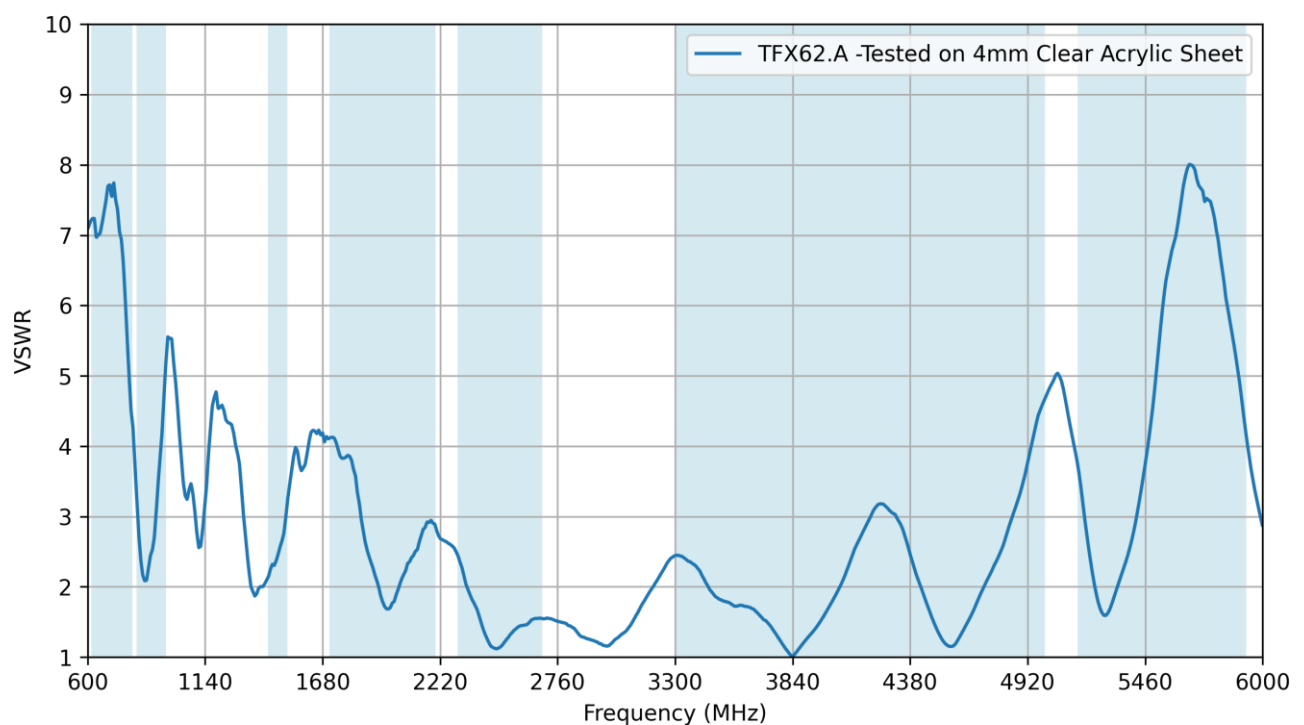

3.3 Efficiency

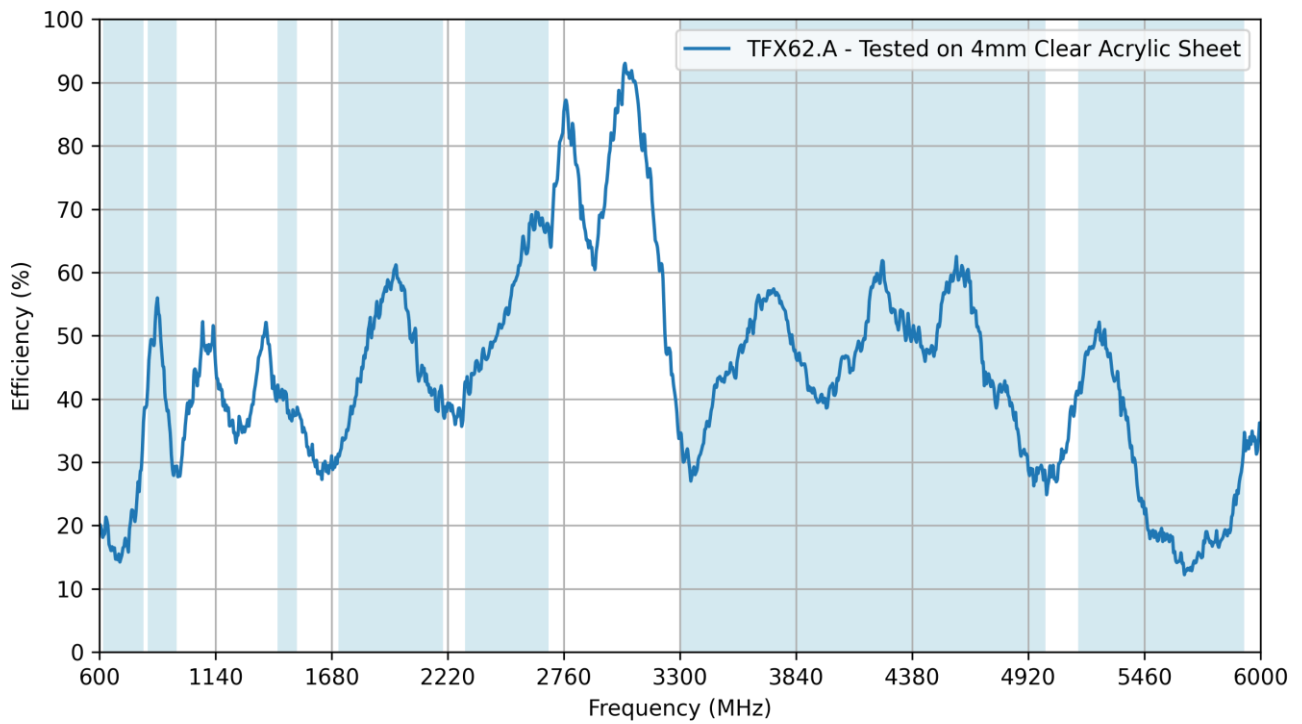

3.4 Average Gain

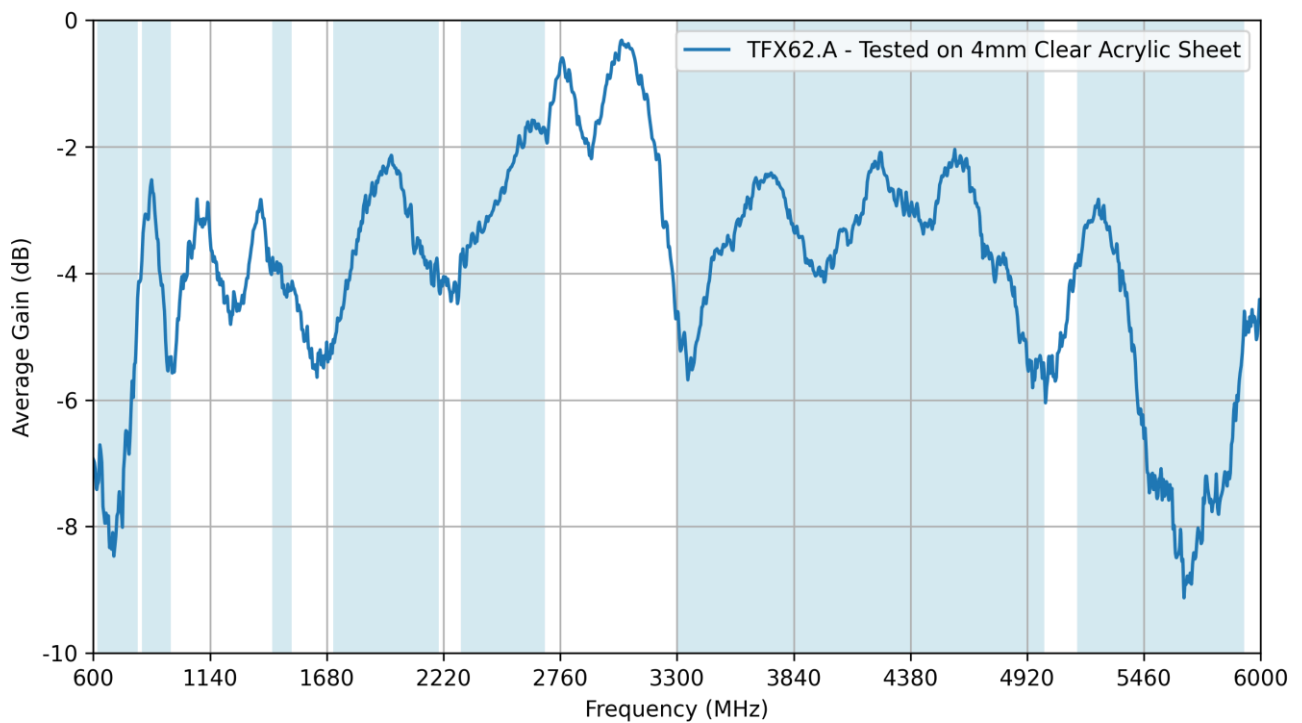

3.5 Peak Gain

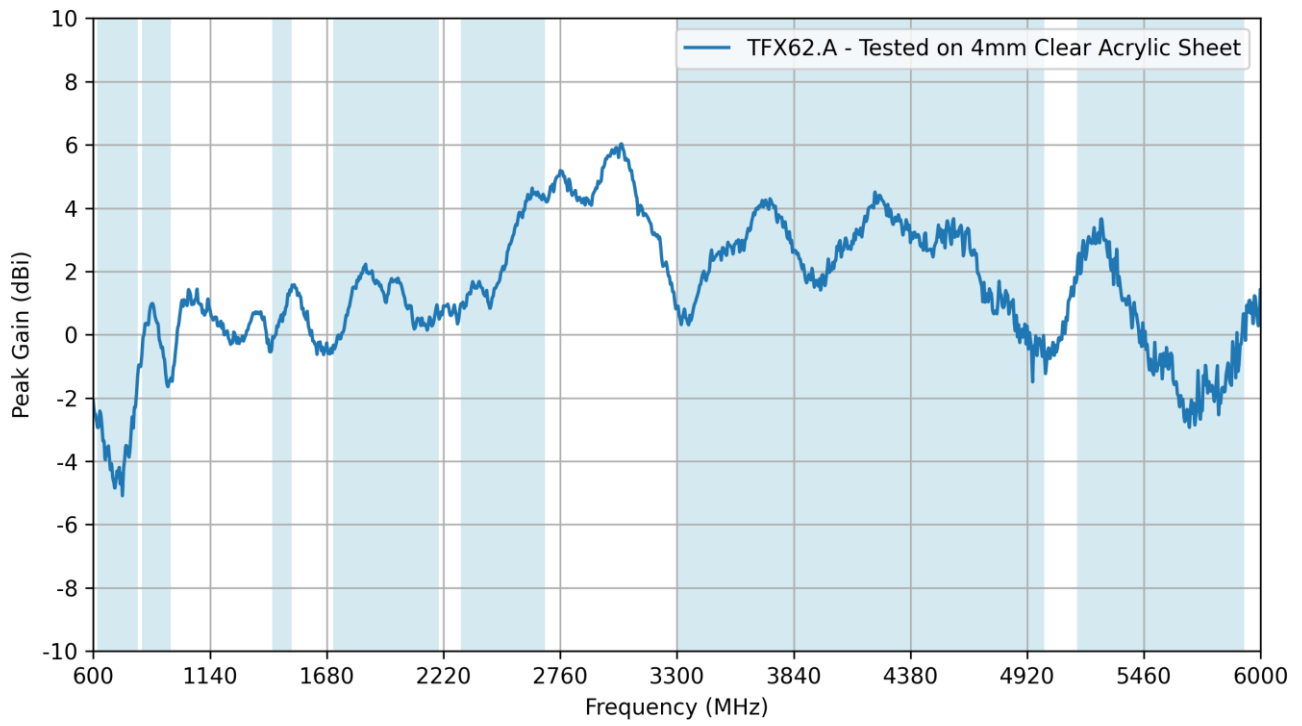

4. Radiation Patterns

4.1 Test Setup

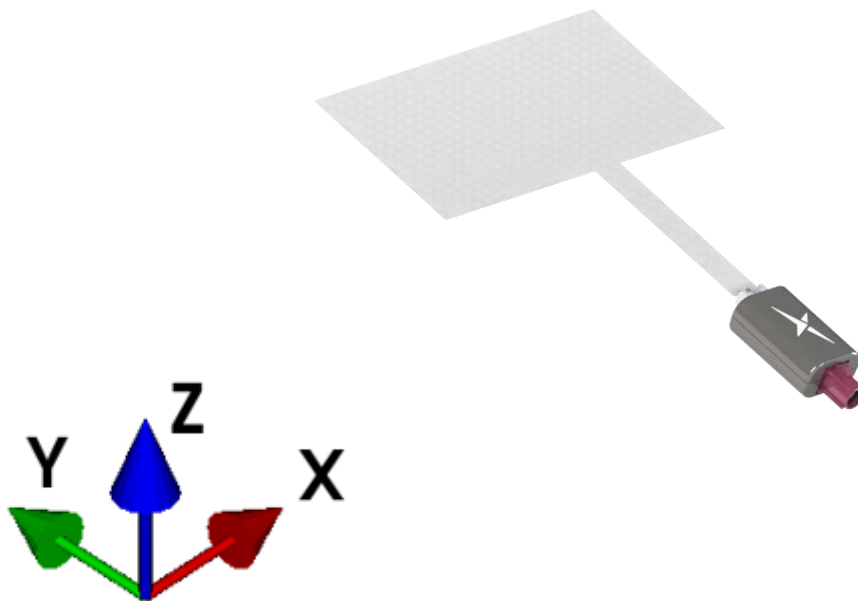
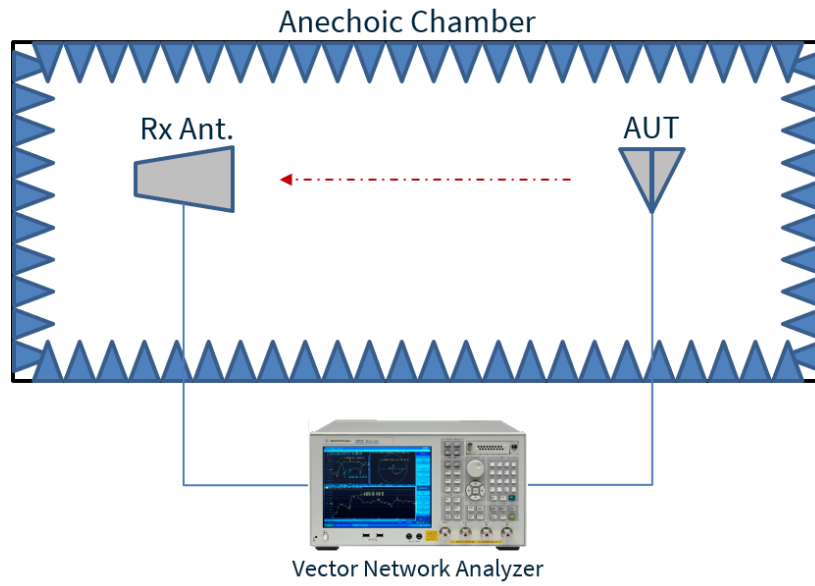

4.2 TFX62.A - Chamber Patterns at 658 MHz

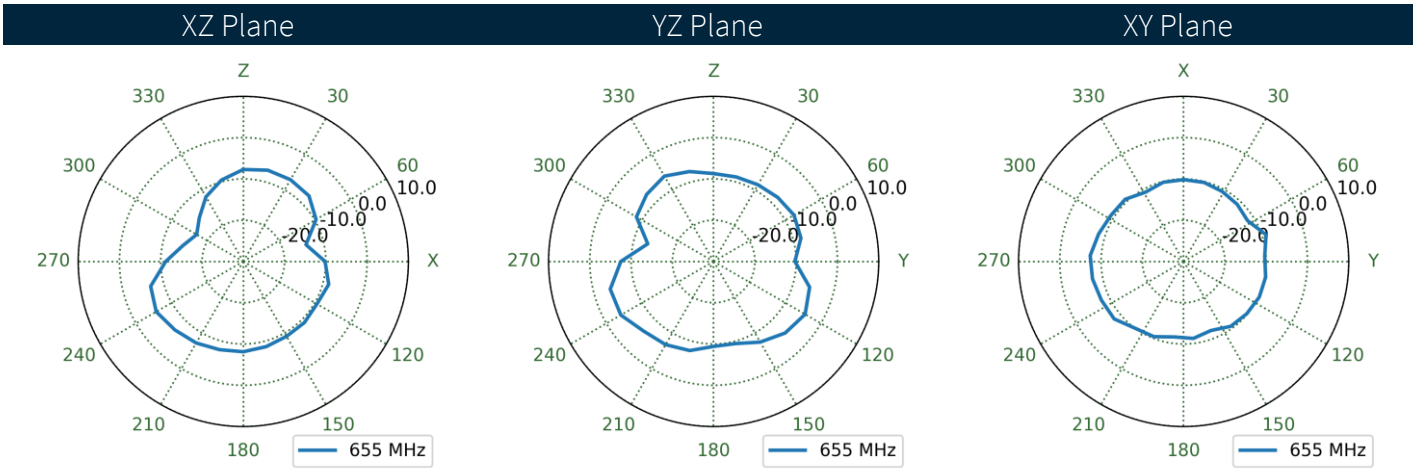
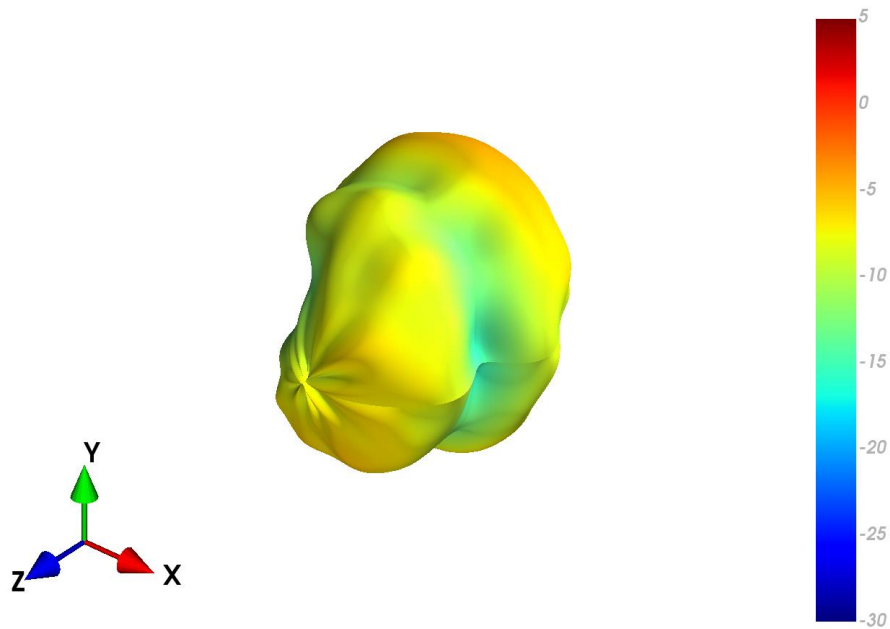

4.3 TFX62.A - Chamber Patterns at 752 MHz

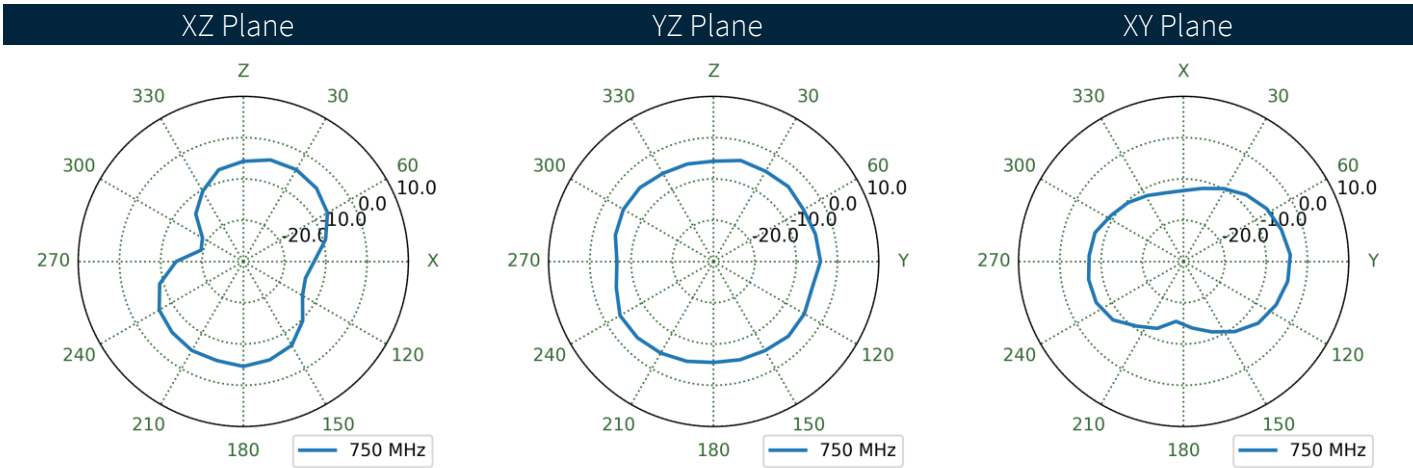
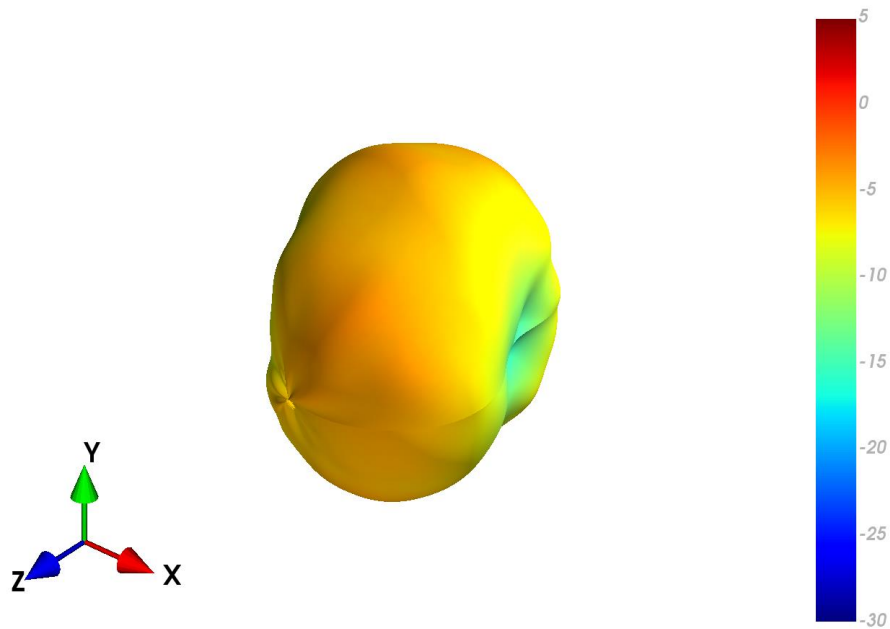

4.4 TFX62.A - Chamber Patterns at 892 MHz

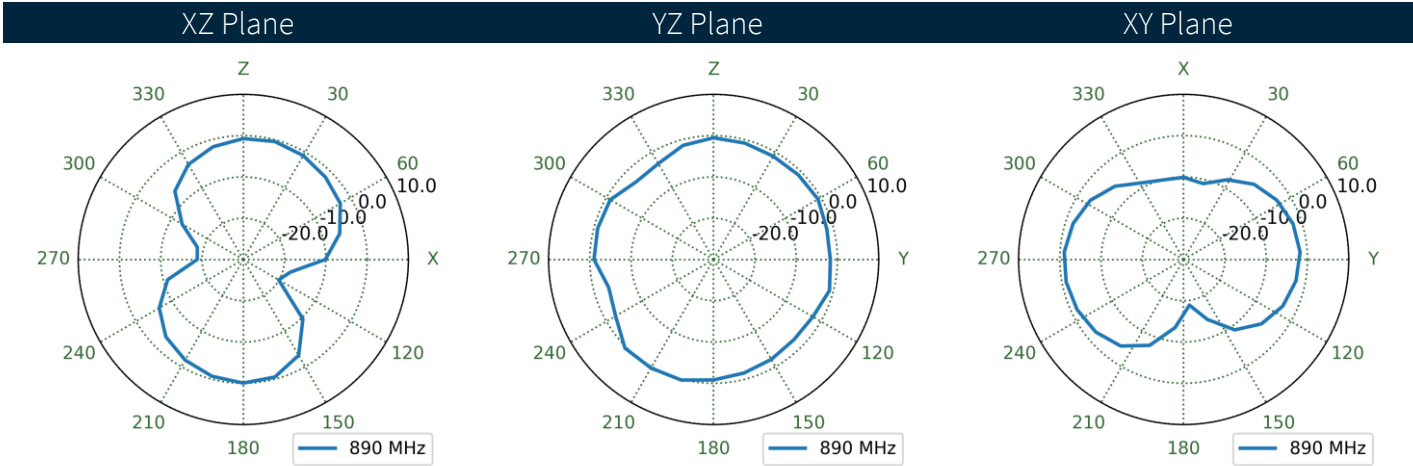
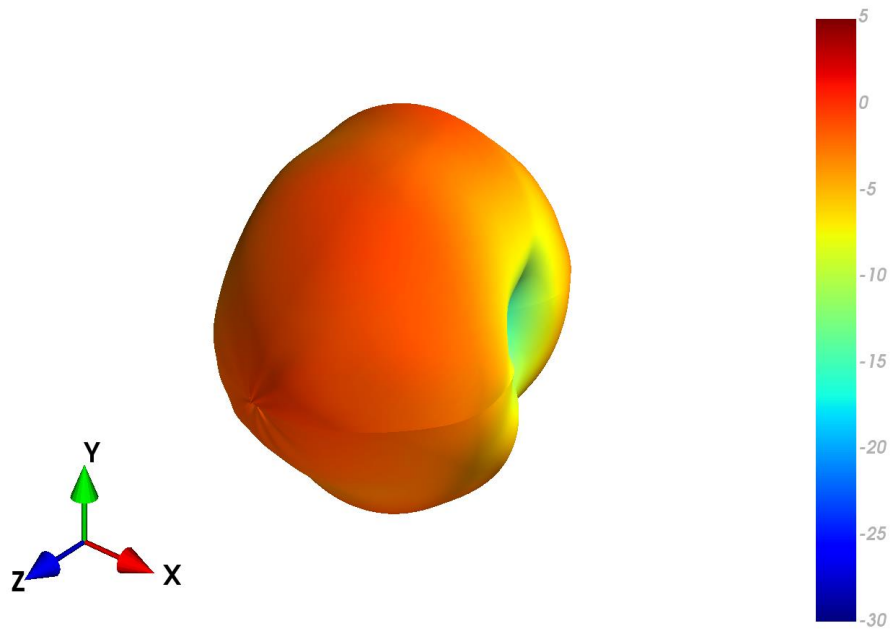

4.5 TFX62.A - Chamber Patterns at 1473 MHz

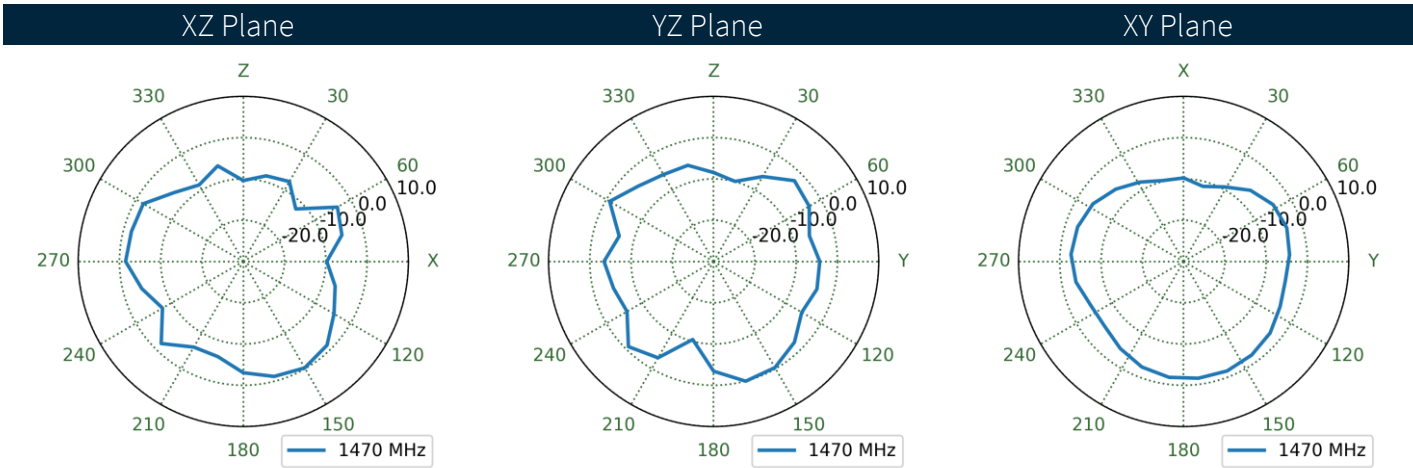
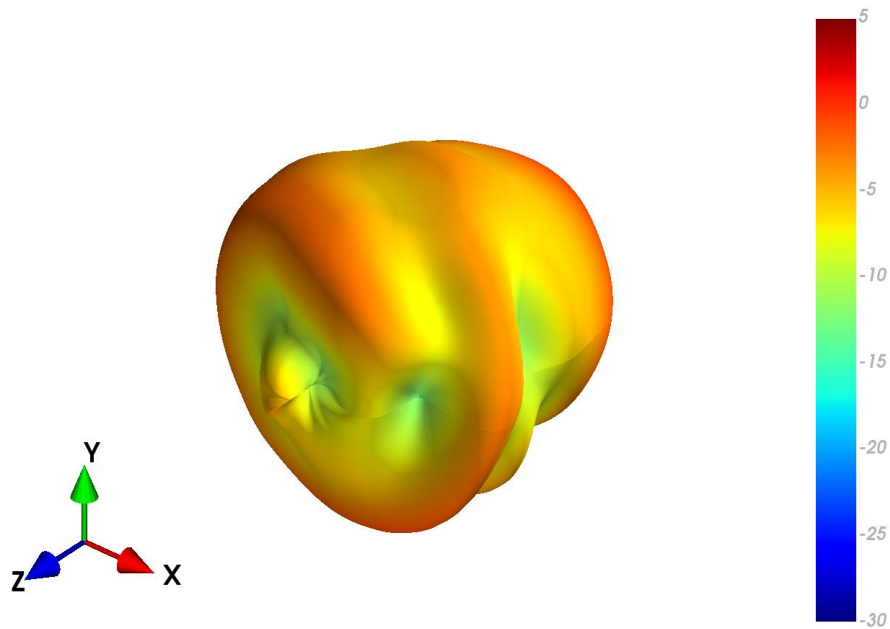

4.6 TFX62.A - Chamber Patterns at 1955 MHz

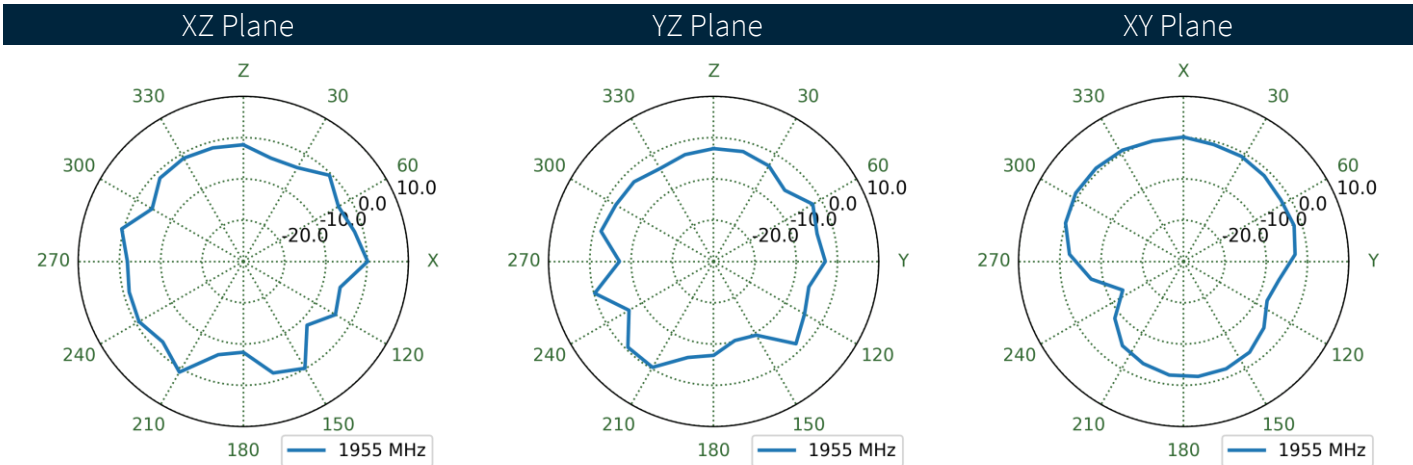
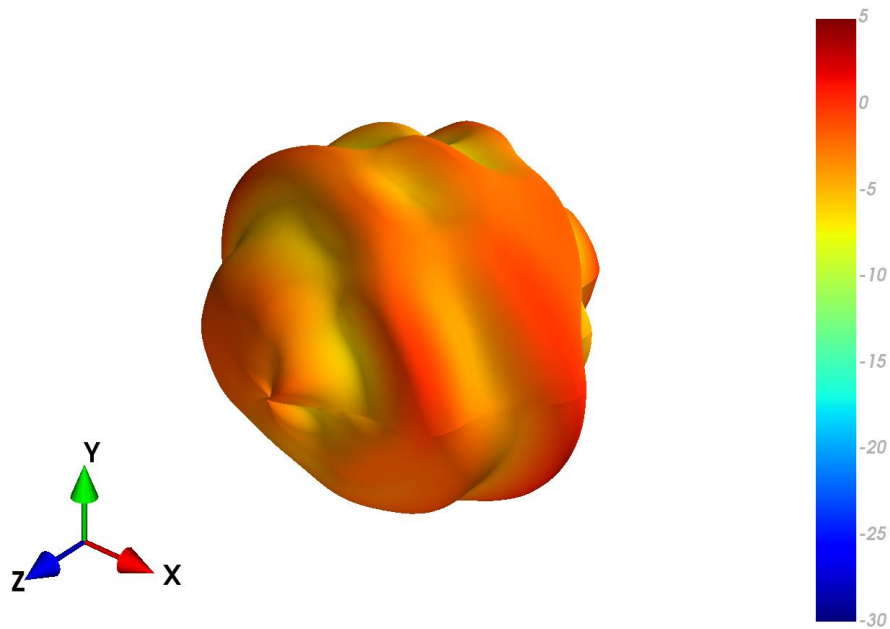

4.7 TFX62.A - Chamber Patterns at 2495 MHz

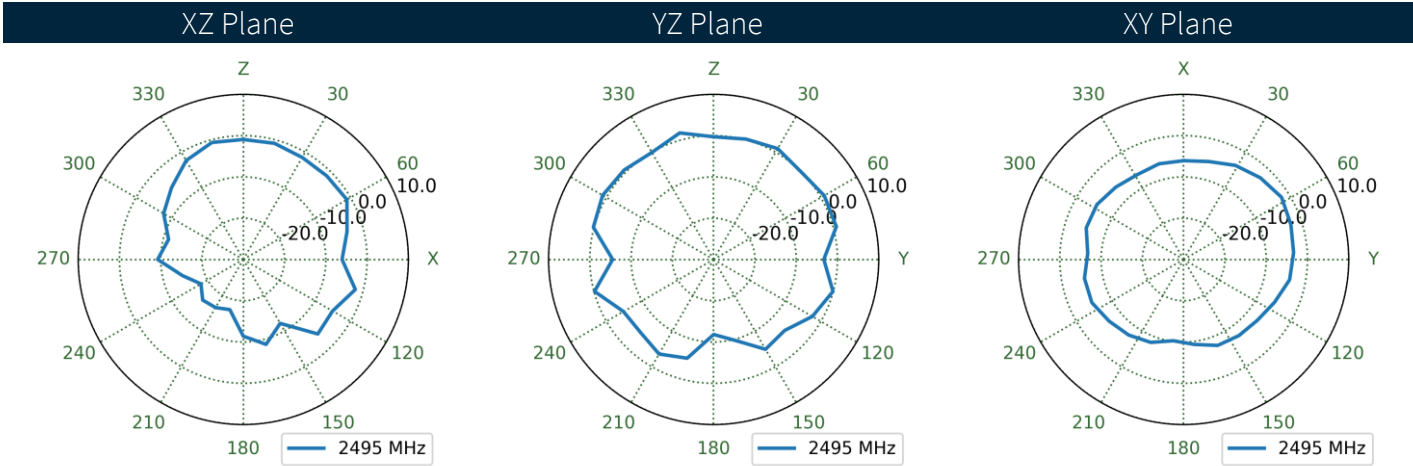
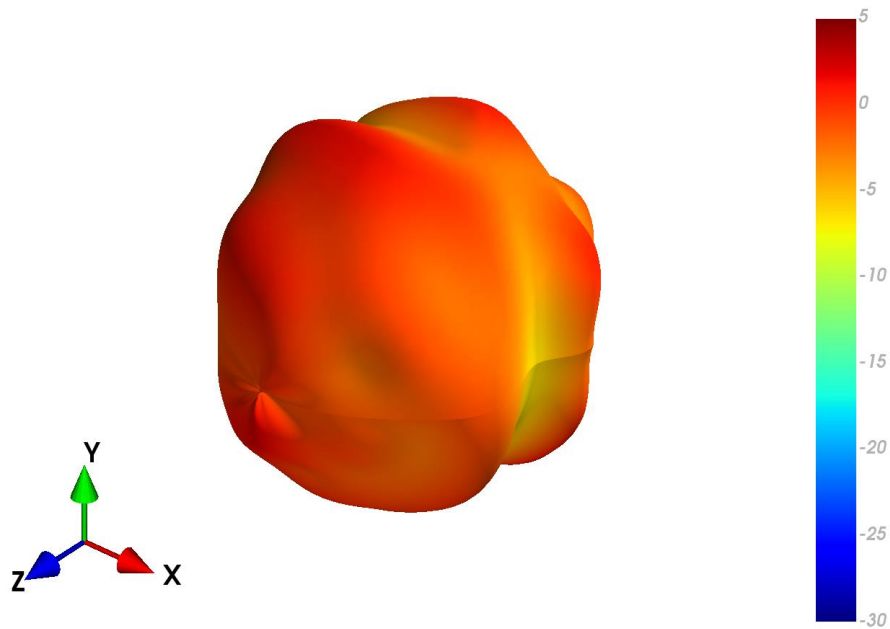

4.8 TFX62.A - Chamber Patterns at 4150 MHz

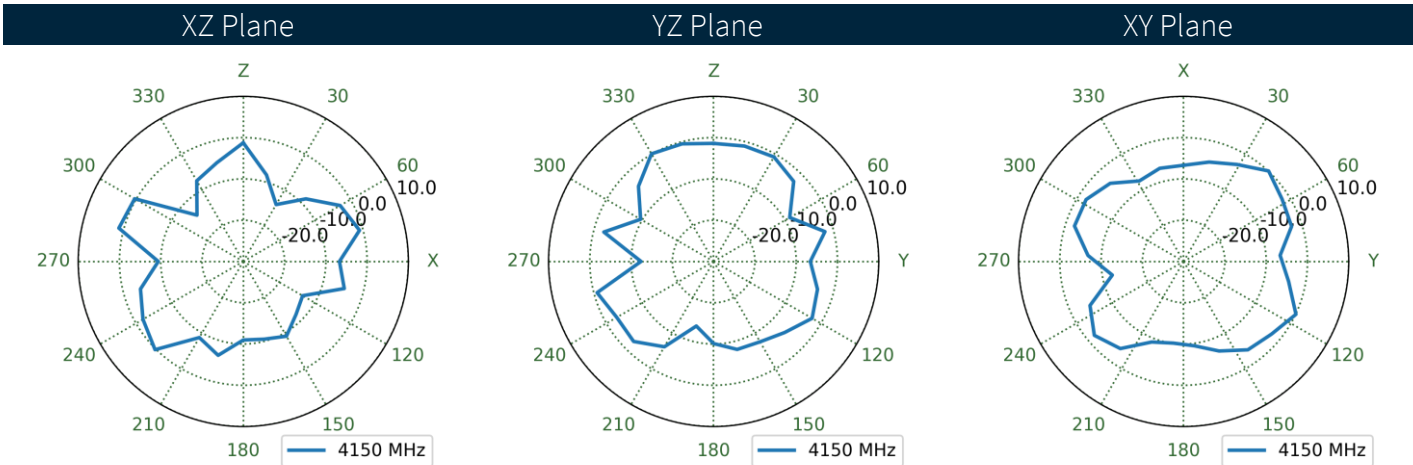
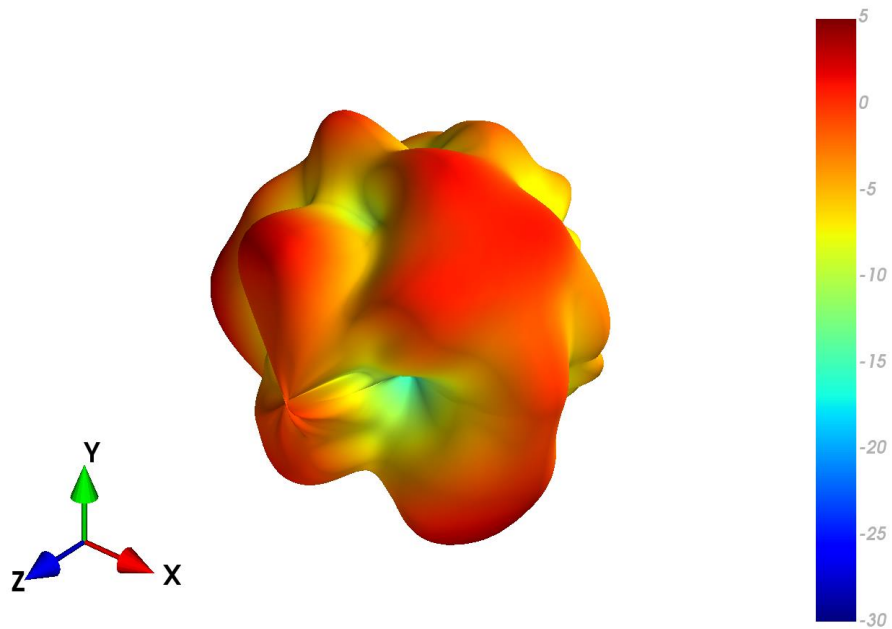

4.9 TFX62.A - Chamber Patterns at 5538 MHz

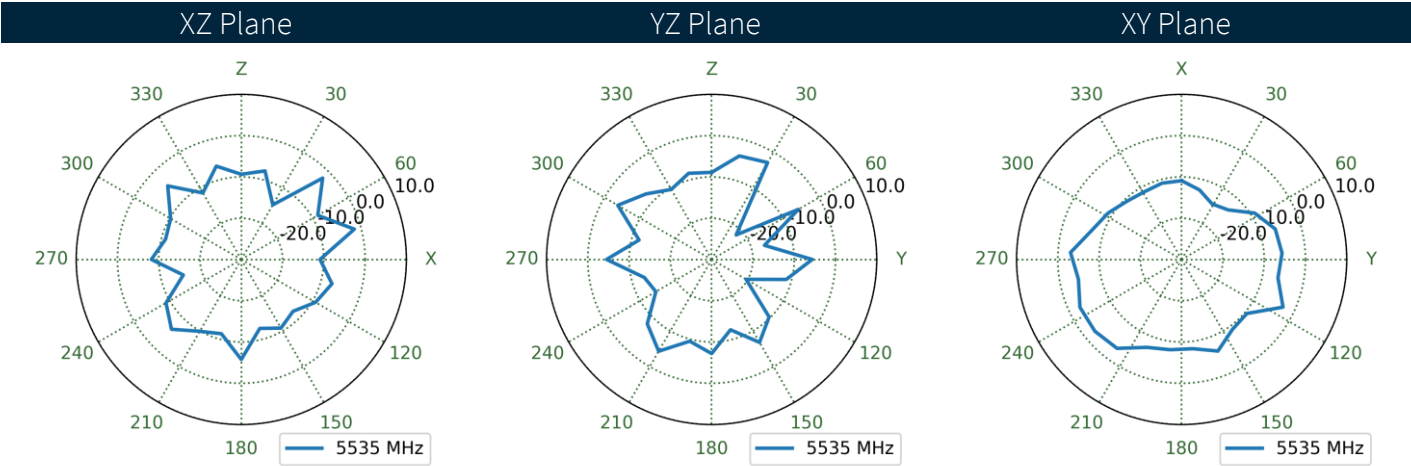
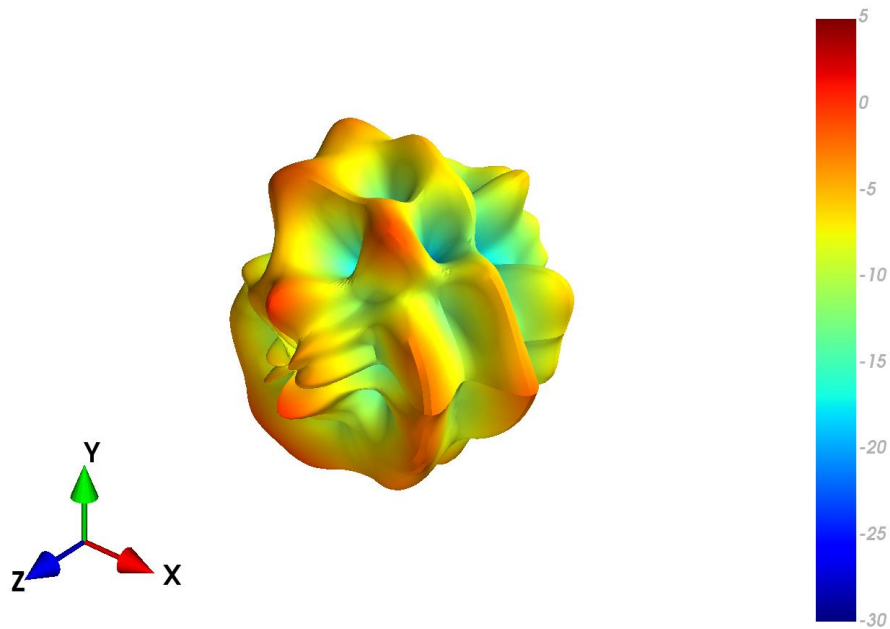

5. Mechanical Drawing

ISO NO.: EDW-22-8-0990
 STATE: RELEASE
 NOTES: ALL MATERIAL MUST BE ROHS COMPLIANT.

REVISIONS				
REV.	DESCRIPTION	DATE	ENGINEER	APPROVED
DO1	FIRST ISSUE	17OCT2022	SC	WL

ITEM NO.	DESCRIPTION	MATERIAL	FINISH	QTY
1	TRANSPARENT FLEX ANTENNA COVERING 600-6000MHz	PET	CLEAR	1
2	FPC-to-BOARD CONNECTOR ADAPTOR 2 CONTACT	LCP	BLACK	1
3	ANTENNA PCB HOUSING	ABS/PC	BLACK	1
4	FAKRA CODE D MALE	NYLON/ZINC	VIOLET	1
5	3M ADHESIVE + LINER	3M 8146	BROWN LINER	1

MODEL VIEW
SCALE 1:3

MODEL VIEW
SCALE 1:3

APPROVED BY:	NW	<p style="font-size: small;">This drawing and its inherent design concepts are property of Taoglas. Not to be copied or given to third parties without the written consent of Taoglas.</p>											
CHECK BY:	WL												
DRAWN BY:	SC												
DATE:	17OCT2022												
UNLESS OTHERWISE SPECIFIED TOLERANCES ARE:	<table style="font-size: x-small; border-collapse: collapse;"> <tr><td>mm</td><td>0,0125</td></tr> <tr><td>mm</td><td>0,025</td></tr> <tr><td>mm</td><td>0,05</td></tr> <tr><td>mm</td><td>0,1</td></tr> <tr><td>mm</td><td>0,2</td></tr> </table>	mm	0,0125	mm	0,025	mm	0,05	mm	0,1	mm	0,2	TITLE:	TRANSPARENT FLEX ANTENNA COVERING 600-6000MHz w/CONVERTER AND FAKRA CODE D MALE
mm	0,0125												
mm	0,025												
mm	0,05												
mm	0,1												
mm	0,2												
THIRD ANGLE PROJECTION		PART NO.:	TFX62.A										
	UNIT: mm	SCALE: 2:5	PAGES: 1/1 REV. DO1										

6. Packaging

TBD



Singel 3 | B-2550 Kontich | Belgium | Tel. +32 (0)3 458 30 33
info@alcom.be | www.alcom.be
Rivium 1e straat 52 | 2909 LE Capelle aan den IJssel | The Netherlands
Tel. +31 (0)10 288 25 00 | info@alcom.nl | www.alcom.nl



www.taoglas.com

