



# TAOGLAS®



# Datasheet

## SuperCombo Series

Part No: MA1047.A.LBICGTT.001

## Description

7-in-1 Shark fin with GNSS, 2x 5G-4G, 2 x Wi-Fi®, 1 AM-FM / WB and 1 DAB and FAKRA Connectors with Pigtail RG-178 Cables

## Features:

Low-profile Shark fin Combination Antenna

- 1x GNSS
- 2x 5G/4G MIMO
- 2x Wi-Fi® MIMO
- 1x AM/FM / WB
- 1x DAB

IP67 Rated Enclosure

Cables: Staggered RG-178

Connectors: FAKRA Series Connectors

Dimensions: 96 x 80 x 60mm

RoHS & Reach Compliant

**Alcom**  
electronics

A STELIAU TECHNOLOGY COMPANY



Singel 3 | B-2550 Kontich | Belgium | Tel.+32(0)3 458 30 33  
info@alcom.be | www.alcom.be

Rivium 1e straat 52 | 2909 LE Capelle aan den IJssel | The Netherlands  
Tel.+31(0)10 288 25 00 | info@alcom.nl | www.alcom.nl

<b>1.</b>	<b>Introduction</b>	<b>3</b>
<b>2.</b>	<b>Specification</b>	<b>4</b>
<b>3.</b>	<b>Mechanical Drawing</b>	<b>8</b>
<b>4.</b>	<b>Antenna Characteristics</b>	<b>9</b>
<b>5.</b>	<b>LNA Characteristics</b>	<b>17</b>
<b>6.</b>	<b>Radiation Patterns</b>	<b>18</b>
<hr/>		
	Changelog	65

Taoglas makes no warranties based on the accuracy or completeness of the contents of this document and reserves the right to make changes to specifications and product descriptions at any time without notice. Taoglas reserves all rights to this document and the information contained herein. Reproduction, use or disclosure to third parties without express permission is strictly prohibited.

Ireland & USA  
ISO 9001:2015  
Certified



Taiwan  
ISO 9001:2015  
Certified



# 1. Introduction



Introducing the Taoglas World SuperCombo MA1047 antenna, an incredibly compact, yet powerful, 7-in-1 shark fin style combination antenna. It provides multiple antenna connections in a sleek, covert enclosure and is suitable for all automotive and commercial trucking applications. The SuperCombo has been engineered to be mounted directly on the vehicle roof and is supplied with pigtail RG-316 cables and FAKRA connectors as standard.

The SuperCombo is designed with active GNSS (GPS/GLONASS/BeiDou/Galileo), 2\*5G/4G Cellular MIMO, 2\*Dual-Band Wi-Fi®, Active AM/FM and DAB. All high-performance antennas are packaged in a compact, robust, IP67 rated enclosure.

The GNSS antenna cover the GPS L1, GLONASS G1, BeiDOu B1, and Galileo E1 bands as well as SBAS. The two high-performance cellular antennas in the SuperCombo cover sub 6GHz, 5G and 5G cellular bands offering efficiencies of up to 80%. Fallback to 3G and 2G bands is also possible where 5G and 4G is not accessible. The Wi-Fi® antennas cover both the 2.4GHz and 5.8GHz Wi-Fi® bands.

Typical Applications Include:

- Transportation and Fleet Management
- Autonomous Driving and Robotics
- FirstNet, First Responders and Emergency Services

The cables, connectors and whip are fully customizable, the antenna is supplied with two whip antennas in the package. For further information or installation instructions contact your regional Taoglas customer support team.

## 2. Specification

GNSS Frequency Bands					
GPS	L1 1575.42 MHz	L2 1227.6 MHz	L5 1176.45 MHz		
	■	□	□		
GLONASS	G1 1602 MHz	G2 1248 MHz	G3 1207 MHz		
	■	□	□		
Galileo	E1 1575.24 MHz	E5a 1176.45 MHz	E5b 1201.5 MHz	E6 1278.75 MHz	
	■	□	□	□	
BeiDou	B1C 1575.42 MHz	B1I 1561 MHz	B2a 1176.45 MHz	B2b 1207.14 MHz	B3 1268.52 MHz
	■	■	□	□	□
L-Band	L-Band 1542 MHz				
	■				
QZSS (Regional)	L1 1575.42 MHz	L2C 1227.6 MHz	L5 1176.45 MHz	L6 1278.75e6	
	■	□	□	□	
IRNSS (Regional)	L5 1176.45 MHz				
	□				
SBAS	L1/E1/B1 1575.42 MHz	L5/B2a/E5a 1176.45 MHz	G1 1602 MHz	G2 1248 MHz	G3 1207 MHz
	■	□	■	□	□

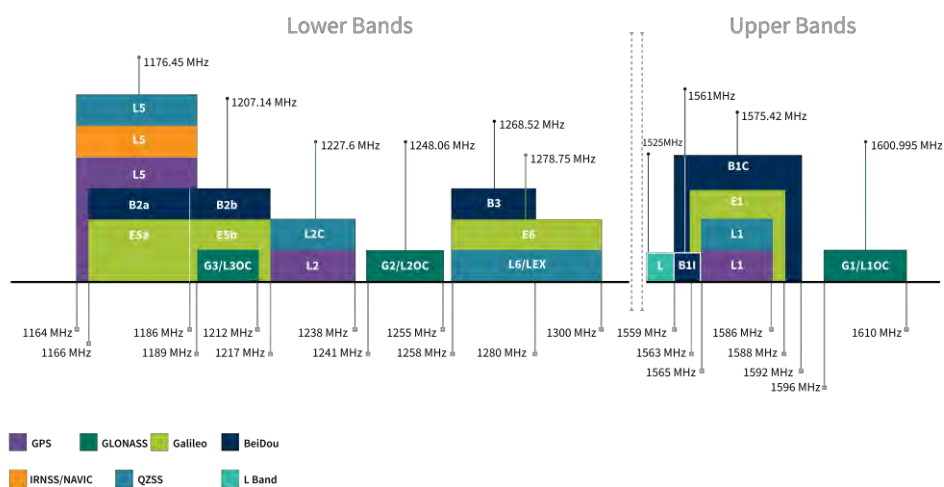

GNSS Bands and Constellations

GNSS Electrical				
Frequency (MHz)		1561	1575.42	1603
VSWR (max.)	60x60cm Metal Ground Plane	4.1	2.4	2.6
	Free space	3.3	2.8	3.2
Efficiency (%)	60x60cm Metal Ground Plane	34.8	42.1	41.9
	Free space	35.0	38.9	26.6
Avg. Gain(dB)	60x60cm Metal Ground Plane	-4.6	-3.8	-3.8
	Free space	-4.6	-4.1	-5.8
Peak Gain(dBi)	60x60cm Metal Ground Plane	4.4	4.4	4.7
	Free space	1.5	1.5	1.1
Polarization			Linear	
Impedance			50Ω	

GNSS Active	
Frequency (MHz)	1575MHz
Gain	30dB
Noise Figure	2.2dB
Current Consumption	39mA
Wi-Fi/Cellular Rejection	30dB 1538MHz, 1630MHz 50dB 1536MHz, 1633MHz

Cellular Electrical									
Band	Frequency (MHz)	Measurement	Efficiency (%)	Average Gain (dB)	Peak Gain (dBi)	Impedance	Polarization	Radiation Pattern	Max. input power
5G NR/4G Band 71	617-698	Cellular 1 - 60x60cm Metal Ground Plane	41.2	-3.85	1.09	50 Ω	Linear	Omni directional	10W
		Cellular 1 - Free Space	26.1	-5.83	1.12				
		Cellular 2 - 60x60cm Metal Ground Plane	12.0	-9.19	-2.13				
		Cellular 2 - Free Space	21.1	-6.76	0.39				
4G/3G Band 12,13,14,17,28,29	698-806	Cellular 1 - 60x60cm Metal Ground Plane	33.2	-4.79	0.76				
		Cellular 1 - Free Space	37.8	-4.22	3.18				
		Cellular 2 - 60x60cm Metal Ground Plane	19.6	-7.07	-0.26				
		Cellular 2 - Free Space	37.4	-4.28	2.79				
4G/3G/NB-IoT/Cat M Band 5,8,18,19,20,26,27	824-960	Cellular 1 - 60x60cm Metal Ground Plane	48.0	-3.18	0.95				
		Cellular 1 - Free Space	46.3	-3.35	2.88				
		Cellular 2 - 60x60cm Metal Ground Plane	16.8	-7.76	-0.83				
		Cellular 2 - Free Space	30.9	-5.10	2.38				
5G NR/4G Band 21,32,74,75,76	1427-1518	Cellular 1 - 60x60cm Metal Ground Plane	17.5	-7.56	-1.12				
		Cellular 1 - Free Space	17.6	-7.54	-2.34				
		Cellular 2 - 60x60cm Metal Ground Plane	20.0	-6.99	-1.19				
		Cellular 2 - Free Space	20.6	-6.85	-0.50				
4G/3G Band 1,2,3,4,9,23,25,35,39,66	1710-2200	Cellular 1 - 60x60cm Metal Ground Plane	35.5	-4.50	3.56				
		Cellular 1 - Free Space	41.2	-3.85	1.60				
		Cellular 2 - 60x60cm Metal Ground Plane	26.8	-5.72	1.96				
		Cellular 2 - Free Space	28.5	-5.45	1.70				
4G/3G Band 7,30,38,40,41	2300-2690	Cellular 1 - 60x60cm Metal Ground Plane	21.7	-6.63	3.38				
		Cellular 1 - Free Space	19.9	-7.02	1.25				
		Cellular 2 - 60x60cm Metal Ground Plane	13.6	-8.66	0.95				
		Cellular 2 - Free Space	14.7	-8.32	-2.34				
5G NR/4G Band 22,42,48,77,78,79	3300-5000	Cellular 1 - 60x60cm Metal Ground Plane	32.7	-4.86	5.32				
		Cellular 1 - Free Space	33.4	-4.76	4.88				
		Cellular 2 - 60x60cm Metal Ground Plane	6.6	-11.82	0.54				
		Cellular 2 - Free Space	6.2	-12.07	-1.70				
CELLULAR5200/Wi-Fi5800	5150-5925	Cellular 1 - 60x60cm Metal Ground Plane	37.3	-4.29	5.72				
		Cellular 1 - Free Space	38.0	-4.20	4.62				
		Cellular 2 - 60x60cm Metal Ground Plane	5.0	-12.98	-1.31				
		Cellular 2 - Free Space	5.4	-12.66	-0.65				

Wi-Fi Electrical									
Band	Frequency (MHz)	Measurement	Efficiency (%)	Average Gain (dB)	Peak Gain (dBi)	Impedance	Polarization	Radiation Pattern	Max. input power
WiFi - 2GHz	2400-2500	Wi-Fi1 - 60x60cm Metal Ground Plane	43.6	-3.60	4.17	50 Ω	Linear	Omni directional	10W
		Wi-Fi1 - Free Space	47.3	-3.25	2.50				
		Wi-Fi2 - 60x60cm Metal Ground Plane	40.7	-3.91	5.66				
		Wi-Fi2 - Free Space	43.9	-3.57	2.36				
WiFi - 5GHz	5150-5850	Wi-Fi1 - 60x60cm Metal Ground Plane	26.4	-5.79	7.06				
		Wi-Fi1 - Free Space	29.7	-5.27	3.93				
		Wi-Fi2 - 60x60cm Metal Ground Plane	32.2	-4.92	8.21				
		Wi-Fi2 - Free Space	33.3	-4.78	3.57				

Mechanical	
Dimensions	96.5 x 80 x 60mm
Material	PC/ASA
Connector	FAKRA
Cable	Staggered RG-178

Environmental	
Waterproof Rating	IP67
Operation Temperature	-40 - +85°C
Storage Temperature	-40 - +85°C

### 3. Mechanical Drawing

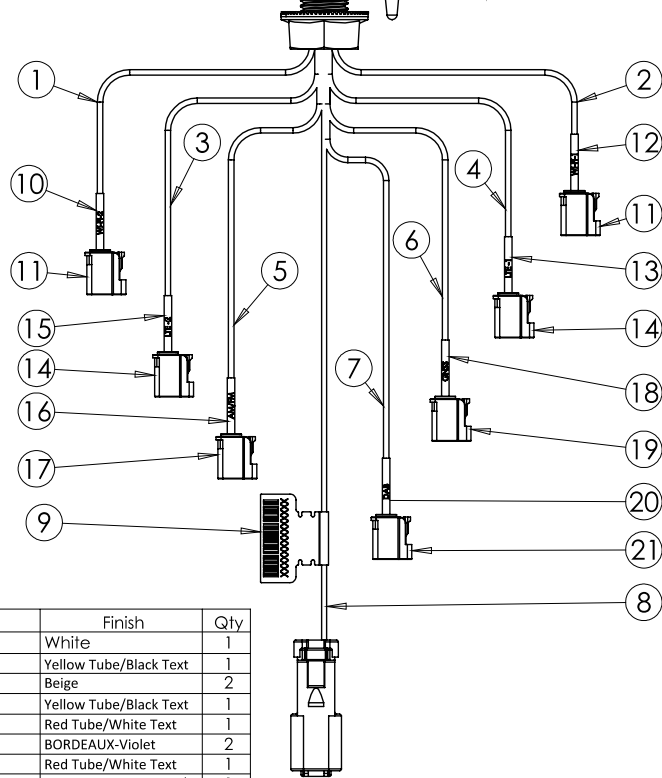
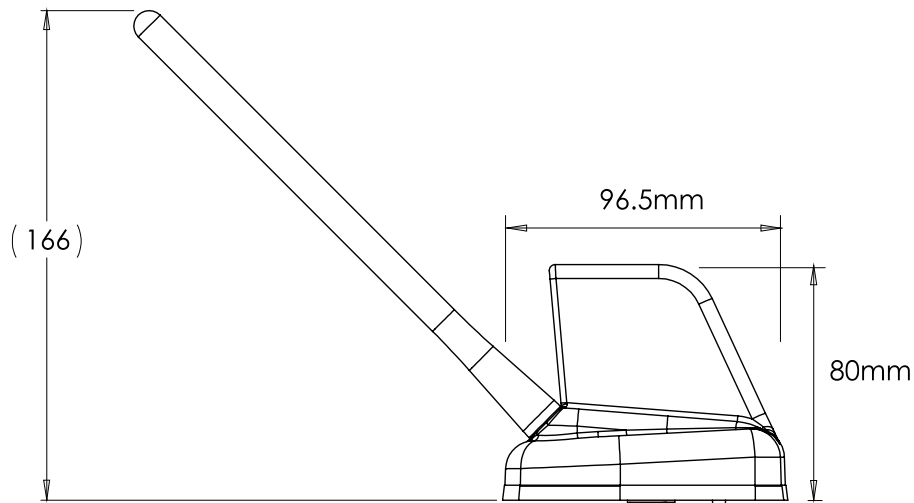

NO	Description	Material	Finish	Qty
9	Empty label (48*30) PEPA White	PEPA	White	1
10	Heat Shrink Tube (Wifi-2)	PE	Yellow Tube/Black Text	1
11	FAKRA CODE I SMB(F)	PA66	Beige	2
12	Heat Shrink Tube (Wifi-1)	PE	Yellow Tube/Black Text	1
13	Heat Shrink Tube (LTE-1)	PE	Red Tube/White Text	1
14	FAKRA CODE D SMB(F)	PA66	BORDEAUX-Violet	2
15	Heat Shrink Tube (LTE-2)	PE	Red Tube/White Text	1
16	Heat Shrink Tube (AM/FM)	PE	Green Tube/WhiteText	1
17	FAKRA CODE B SMB(F)	PA66	Cream	1
18	Heat Shrink Tube (GNSS)	PE	Blue Tube/White Text	1
19	FAKRA CODE C SMB(F)	PA66	Blue	1
20	Heat Shrink Tube (DAB)	PE	Green Tube/WhiteText	1
21	FAKRA CODE A SMB(F)	PA66	Jet Black	1

CABLE LENGTHS FROM BASE			
ITEM NO.	DESCRIPTION	CABLE LENGHT FROM BASE +/- 10.0MM	CABLE
1	MA1146.A.LBICGT.003 WIFI-1 cable, RG-178(Brown)_Fakra 2 SMB (F) ST_Code I	250mm ± 15mm	RG 178
2	MA1146.A.LBICGT.003 WIFI-2 cable, RG-178(Brown)_Fakra 2 SMB (F) ST_Code I	225mm ± 15mm	RG 178
3	LTE-1 - MA1146.A.LBICGT.003 LTE-1 cable, RG-178(Brown)_Fakra 2 SMB (F) ST_Code D	250mm ± 15mm	RG 178
4	LTE-2 - MA1146.A.LBICGT.003 LTE-2 cable, RG-178(Brown)_Fakra 2 SMB (F) ST_Code D	225mm ± 15mm	RG 178
5	AM/FM - MA1146.A.LBICGT.003 AM/FM cable, RG-178(Brown)_Fakra 2 SMB (F) ST_Code Z	325mm ± 30mm	RG 178
6	GNSS - MA1146.A.LBICGT.003 GNSS cable, RG-178(Brown)_Fakra 2 SMB (F) ST_Code C	300mm ± 30mm	RG 178
7	DAB - MA1047.A.LBICGT.001 DAB cable, RG-178(Brown)_Fakra 2 SMB (F) ST_Code B	325mm ± 30mm	RG 178
8	MA1047.A.LBICGT.001 Power cable	450mm ± 30mm	18 AWG



## 4. Antenna Characteristics

### 4.1 GNSS - Return Loss

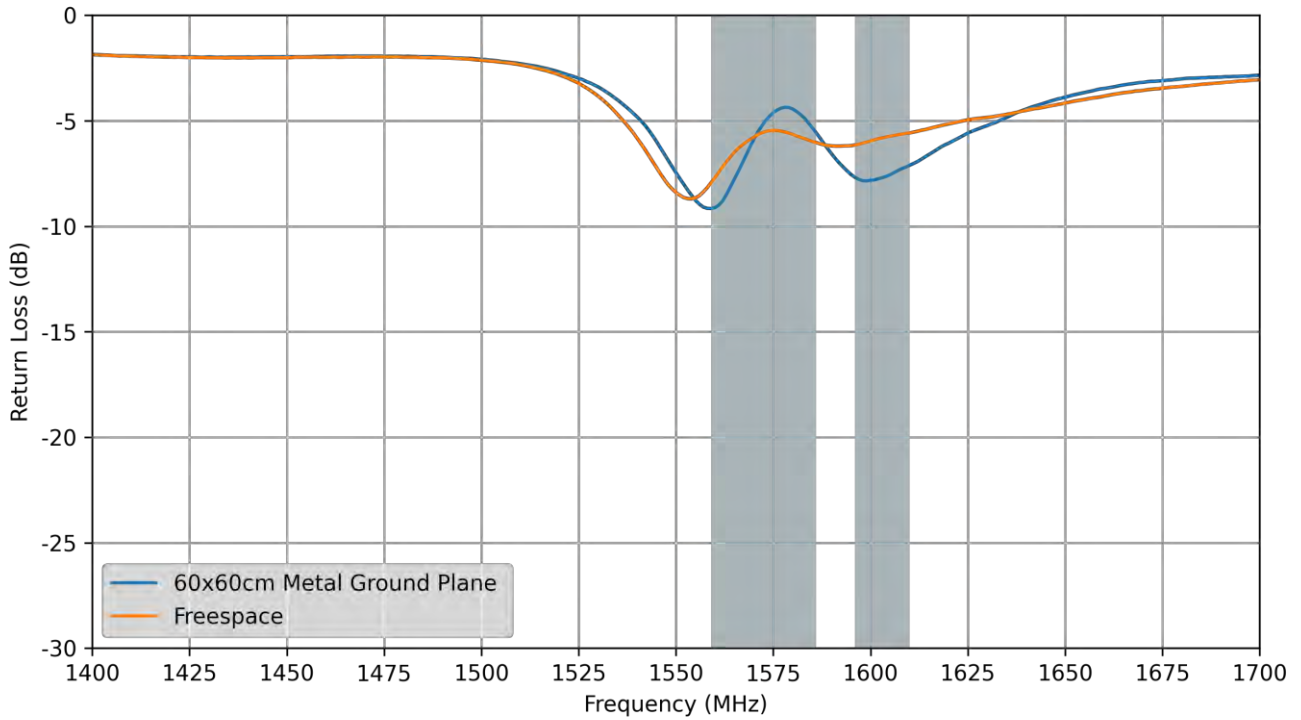

### 4.2 GNSS - VSWR

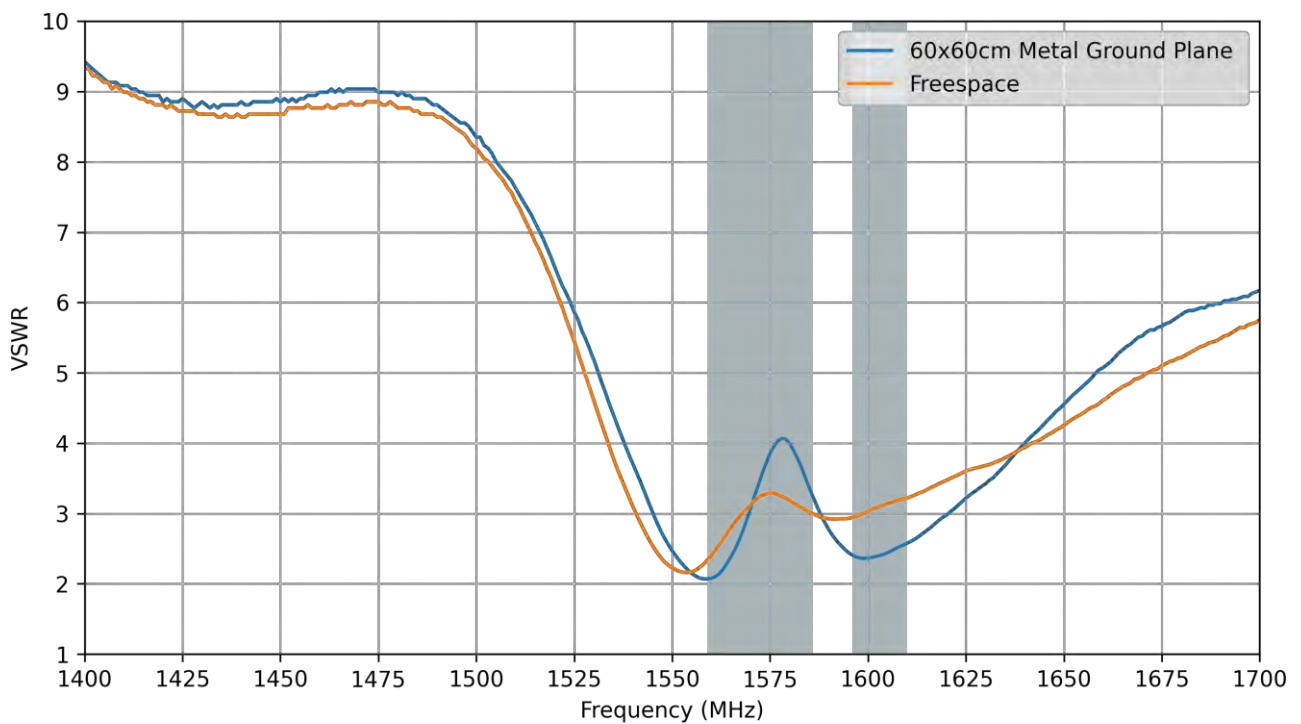

### 4.3 GNSS - Efficiency

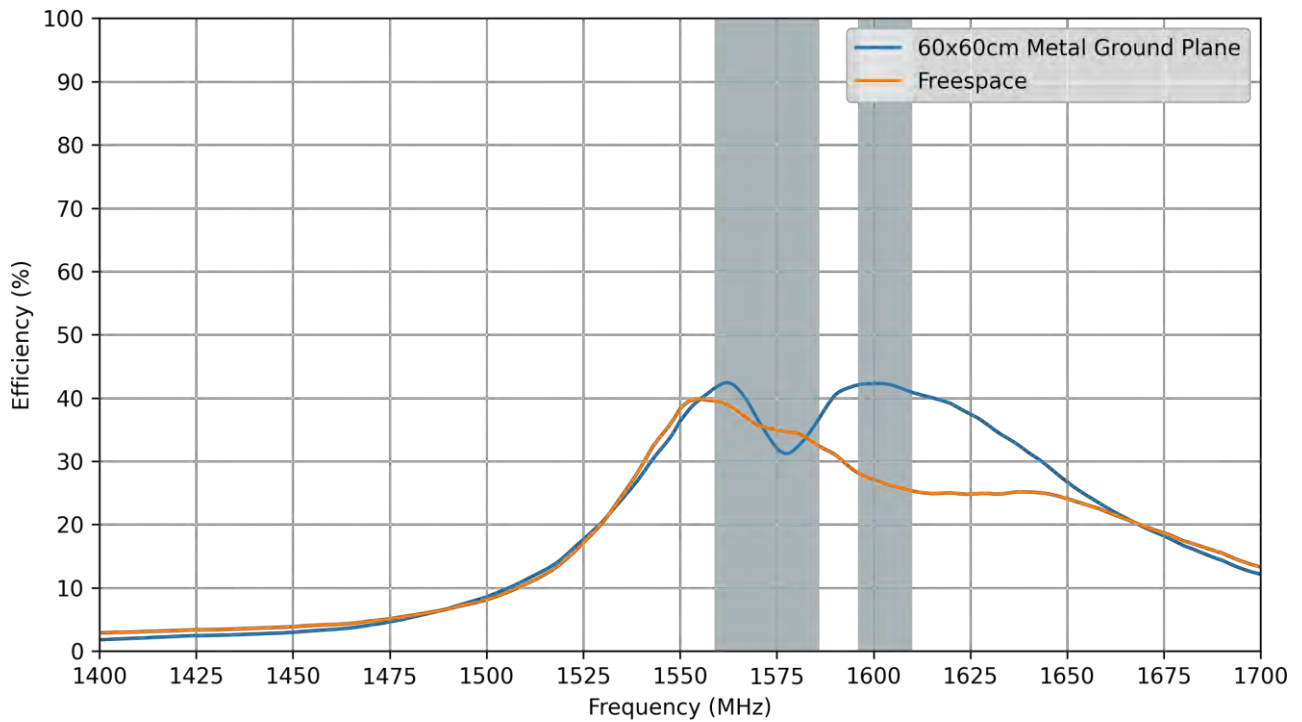

### 4.4 GNSS - Average Gain

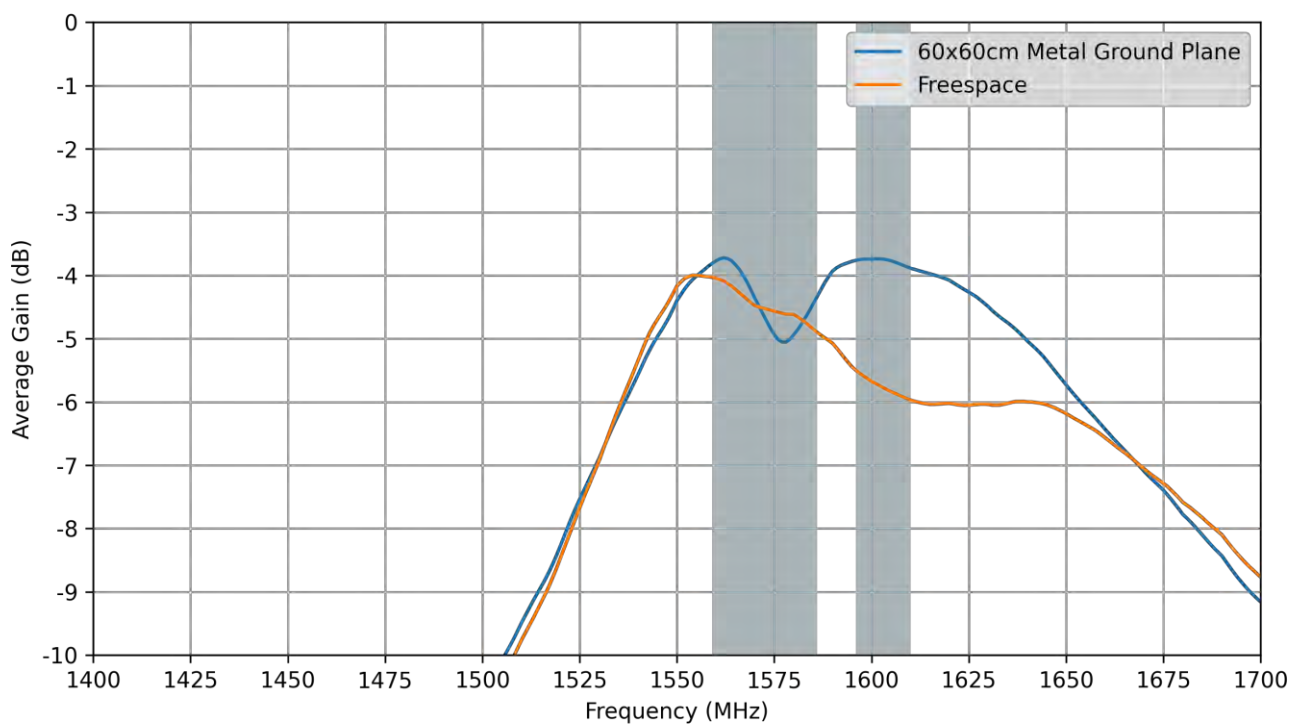

### 4.5 GNSS - Peak Gain

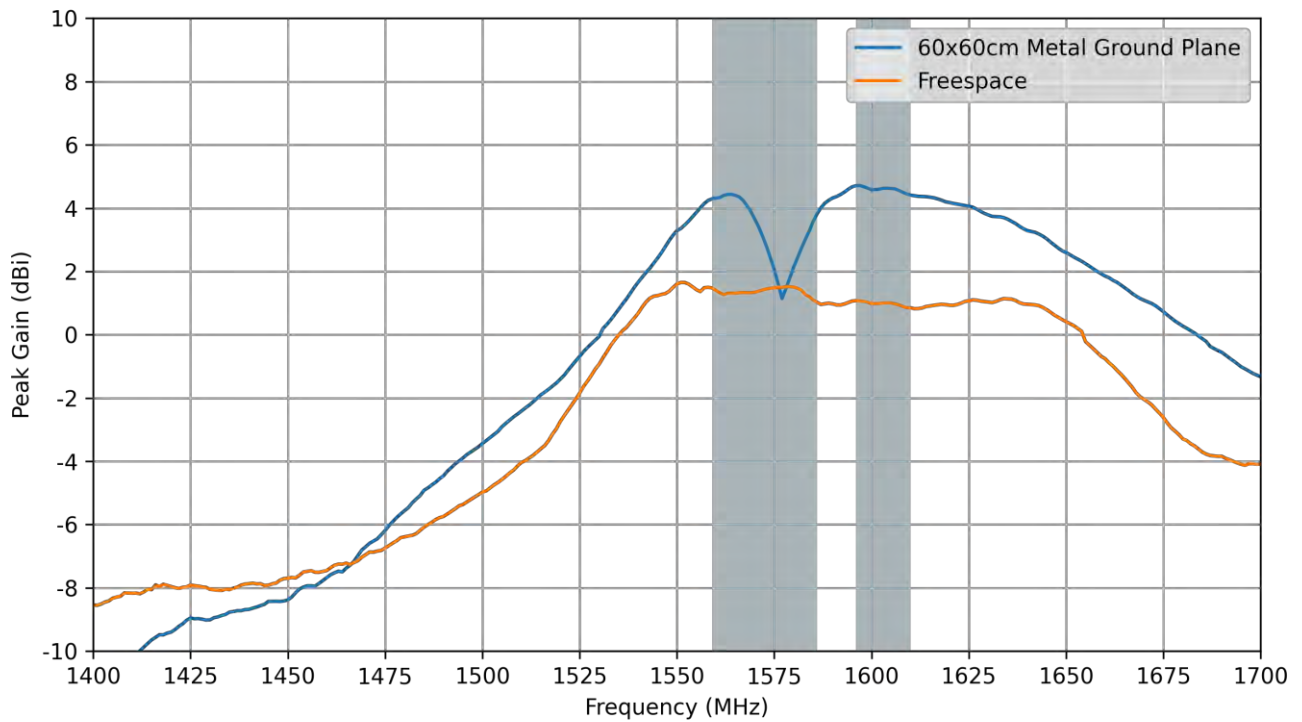

### 4.6 Cellular - Return Loss

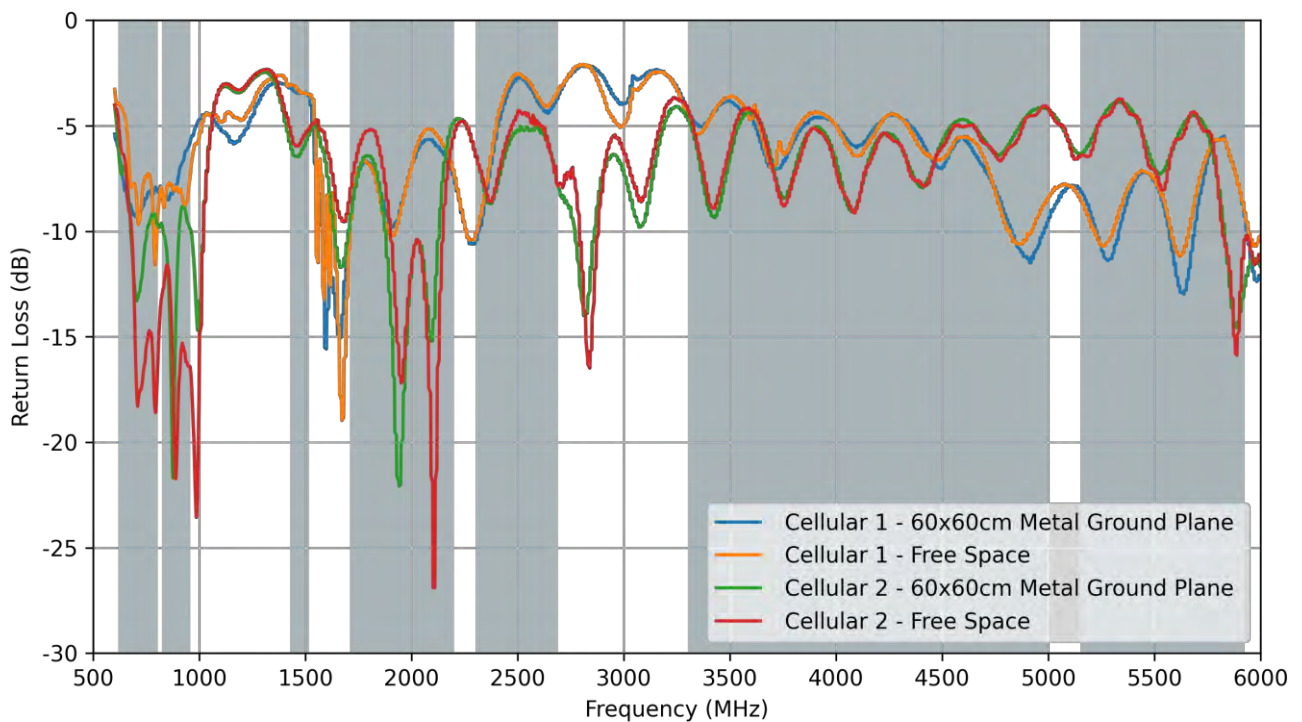

## 4.7 Cellular - VSWR

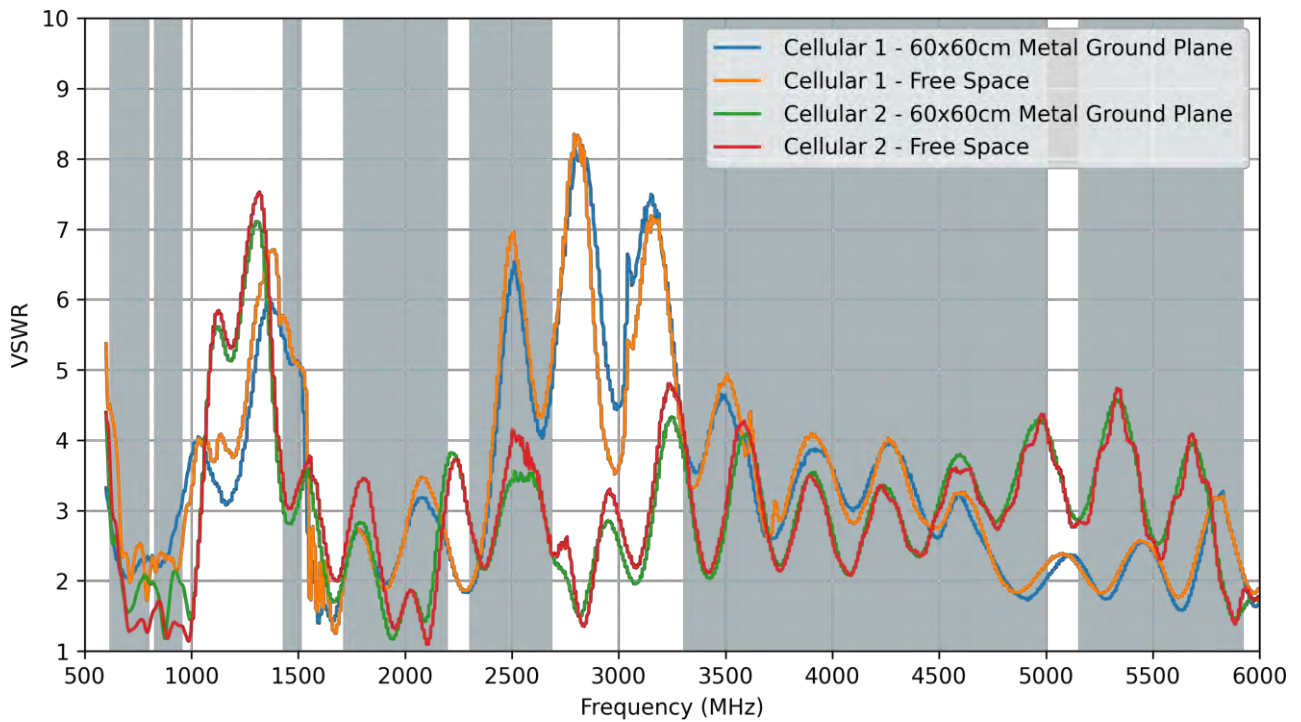

## 4.8 Cellular - Efficiency

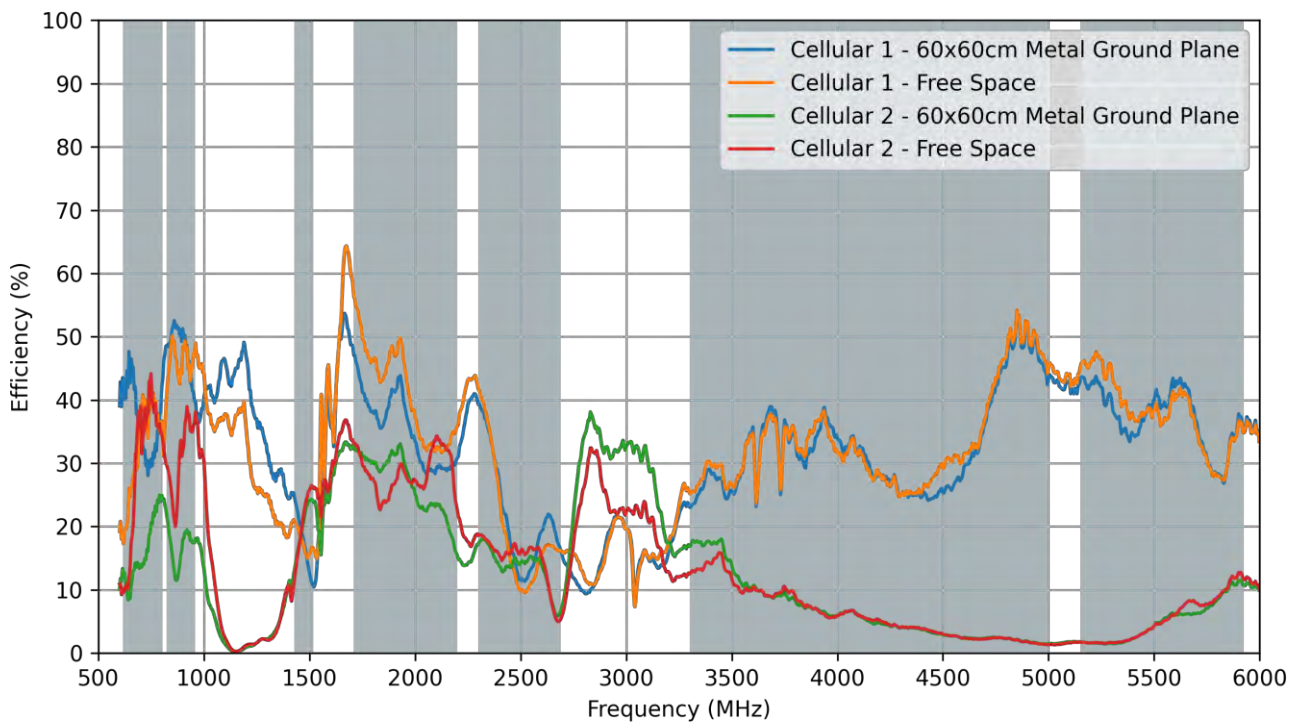

### 4.9 Cellular - Average Gain

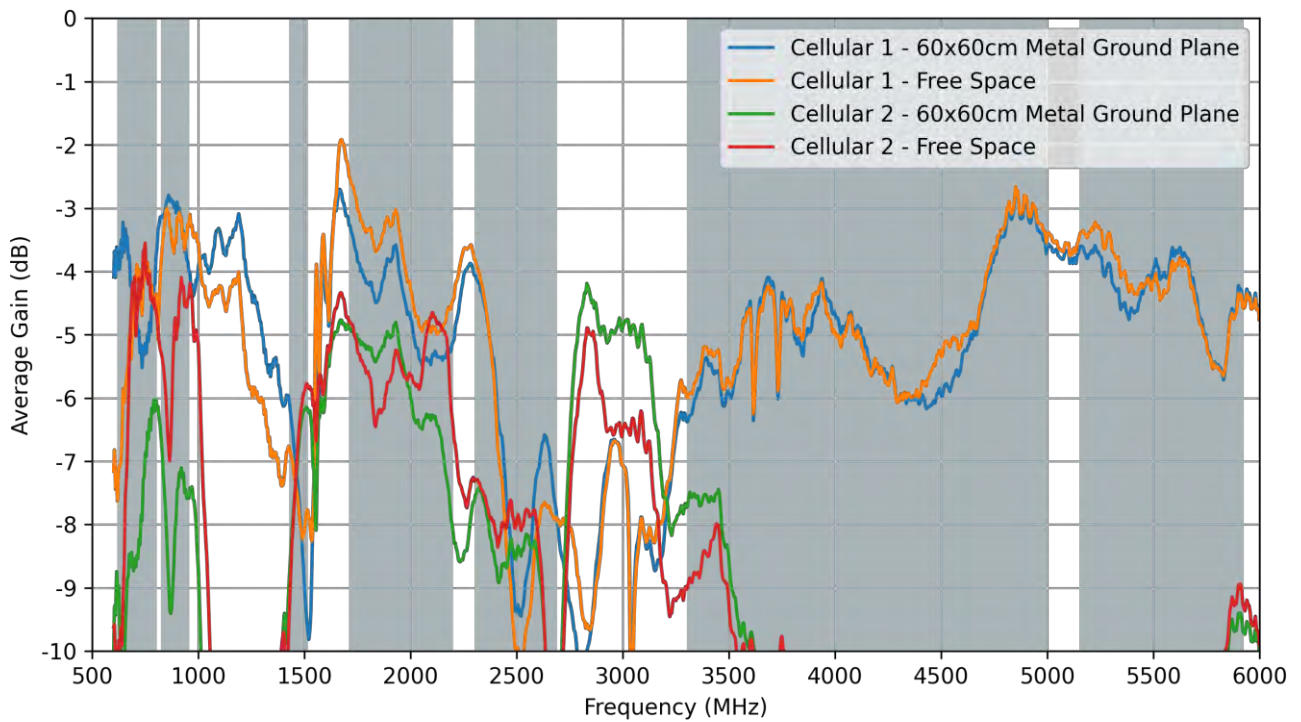

### 4.10 Cellular - Peak Gain

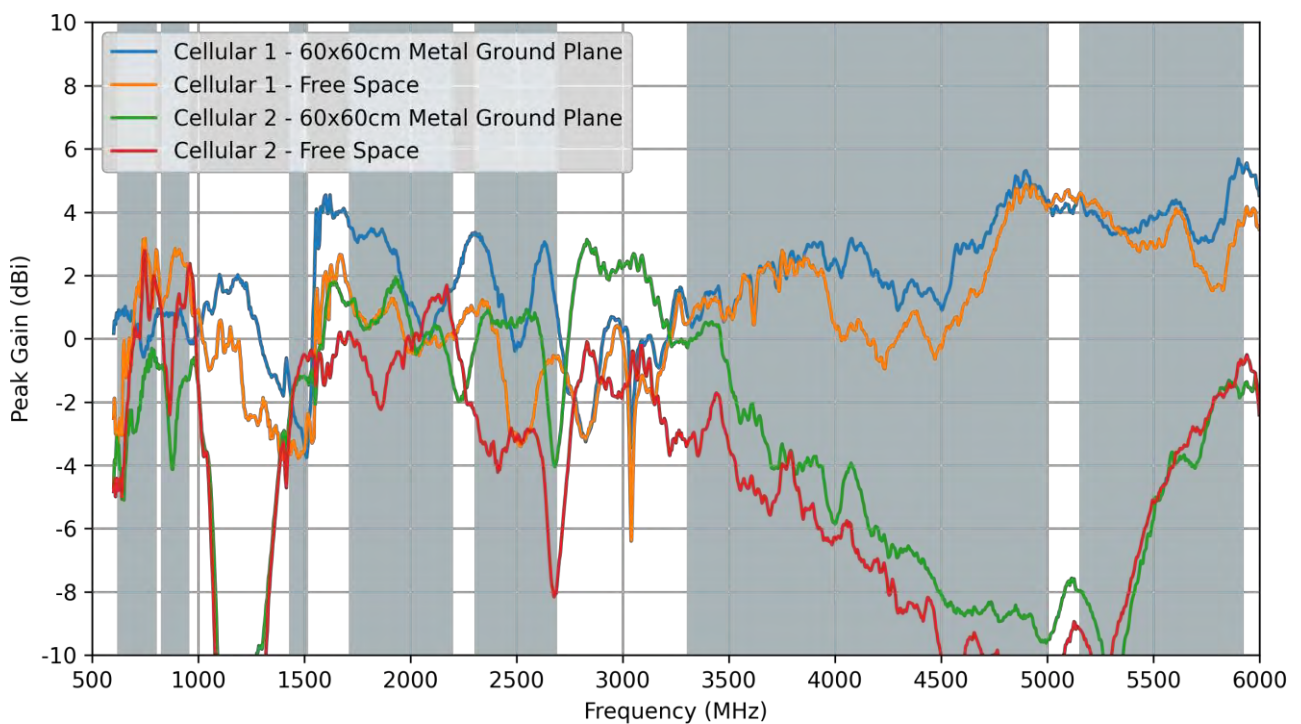

### 4.11 Wi-Fi - Return Loss

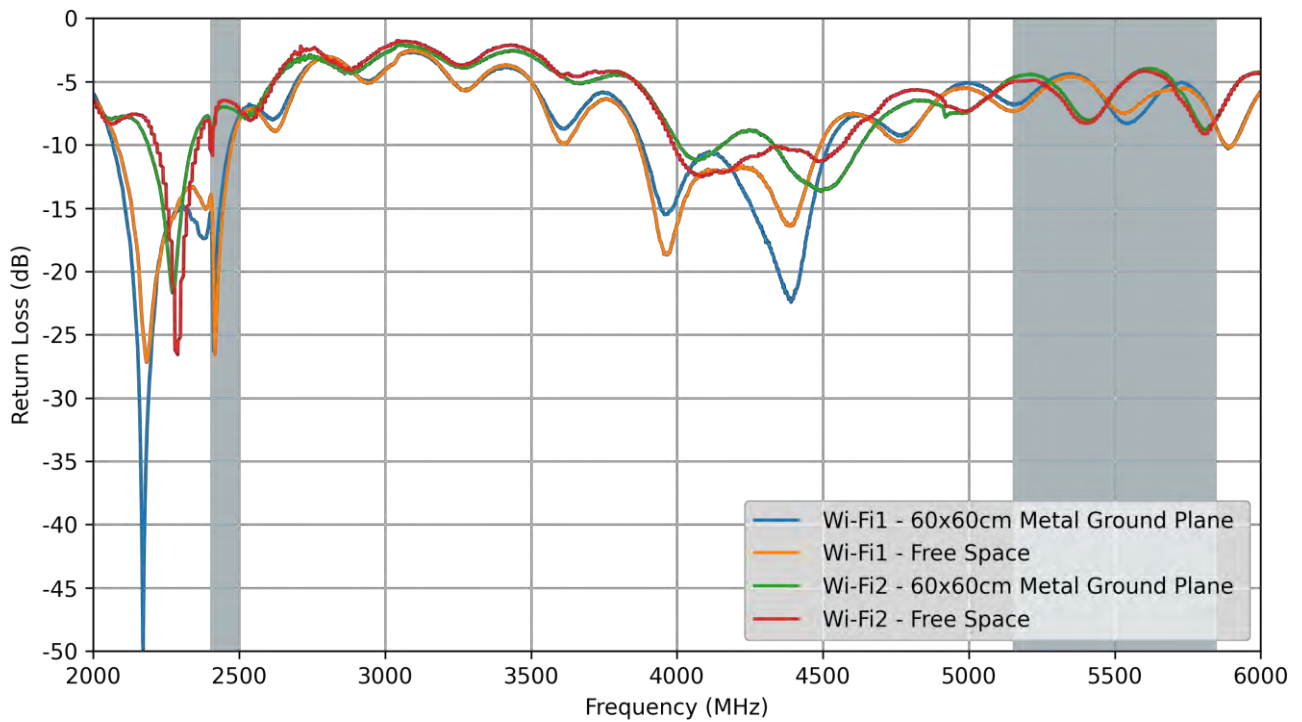

### 4.12 Wi-Fi - VSWR

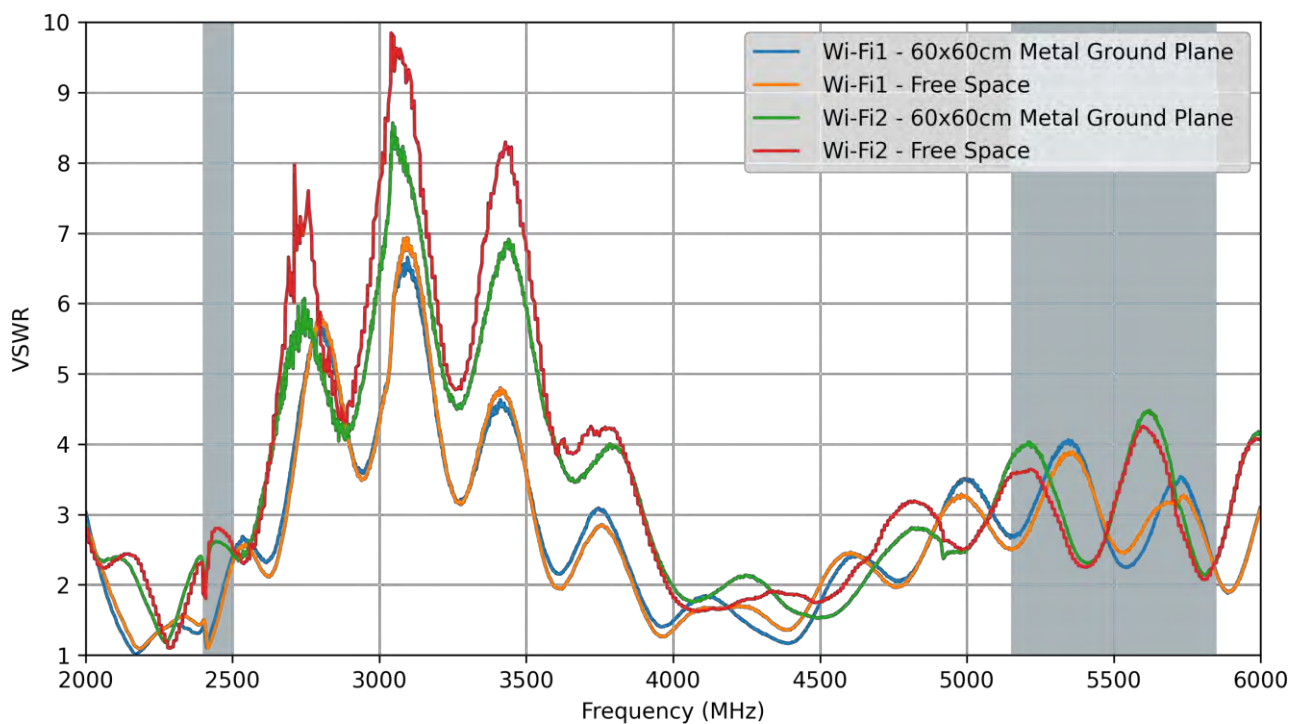

### 4.13 Wi-Fi - Efficiency

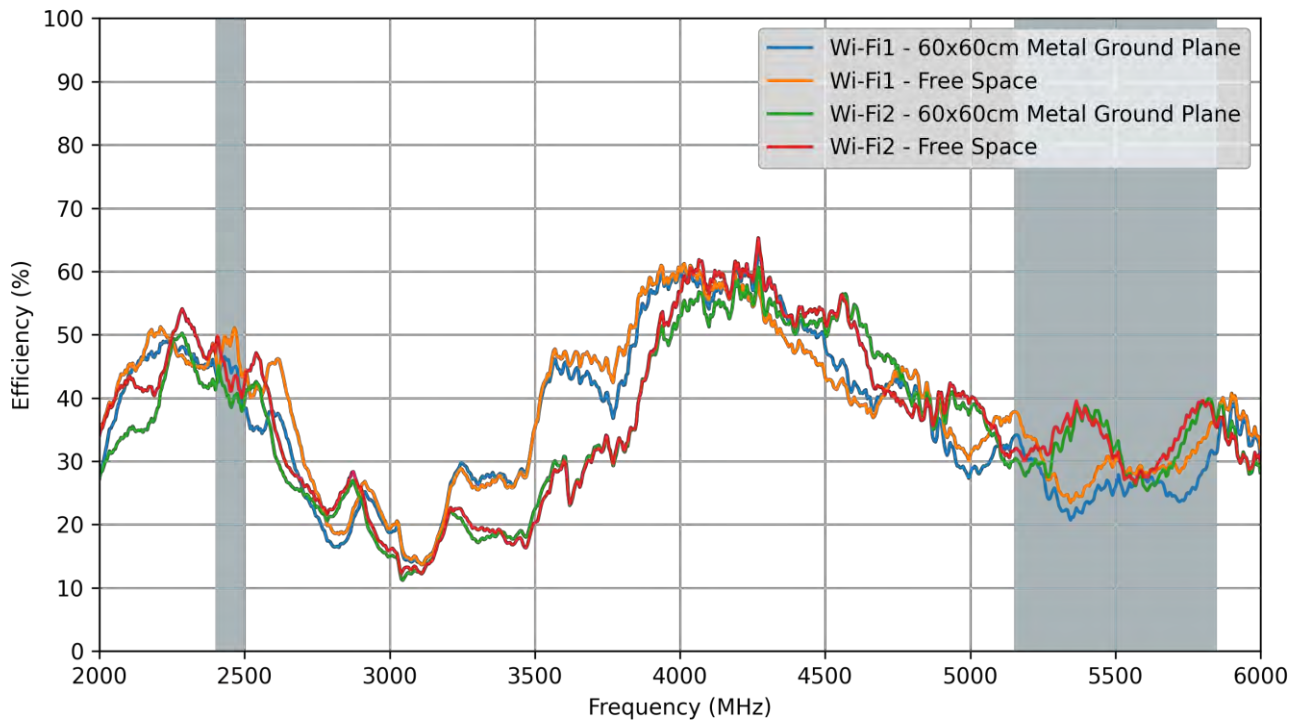

### 4.14 Wi-Fi - Average Gain

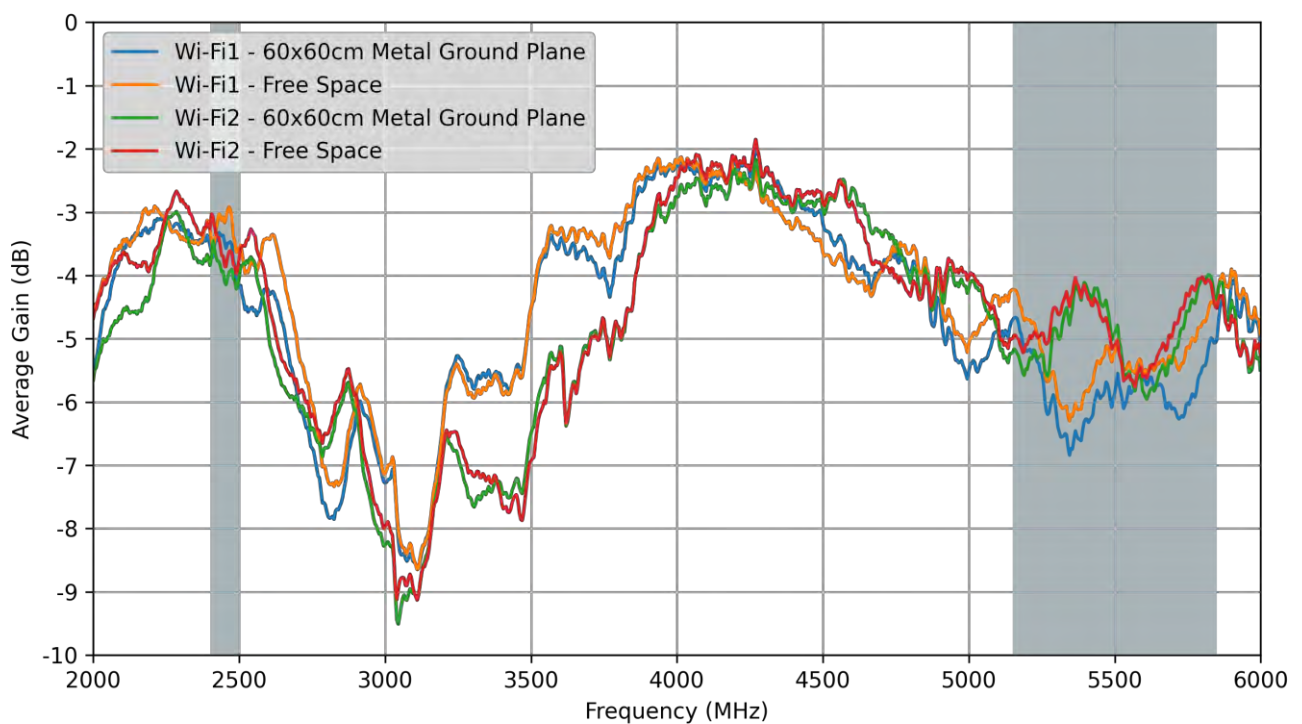

### 4.15 Wi-Fi - Peak Gain

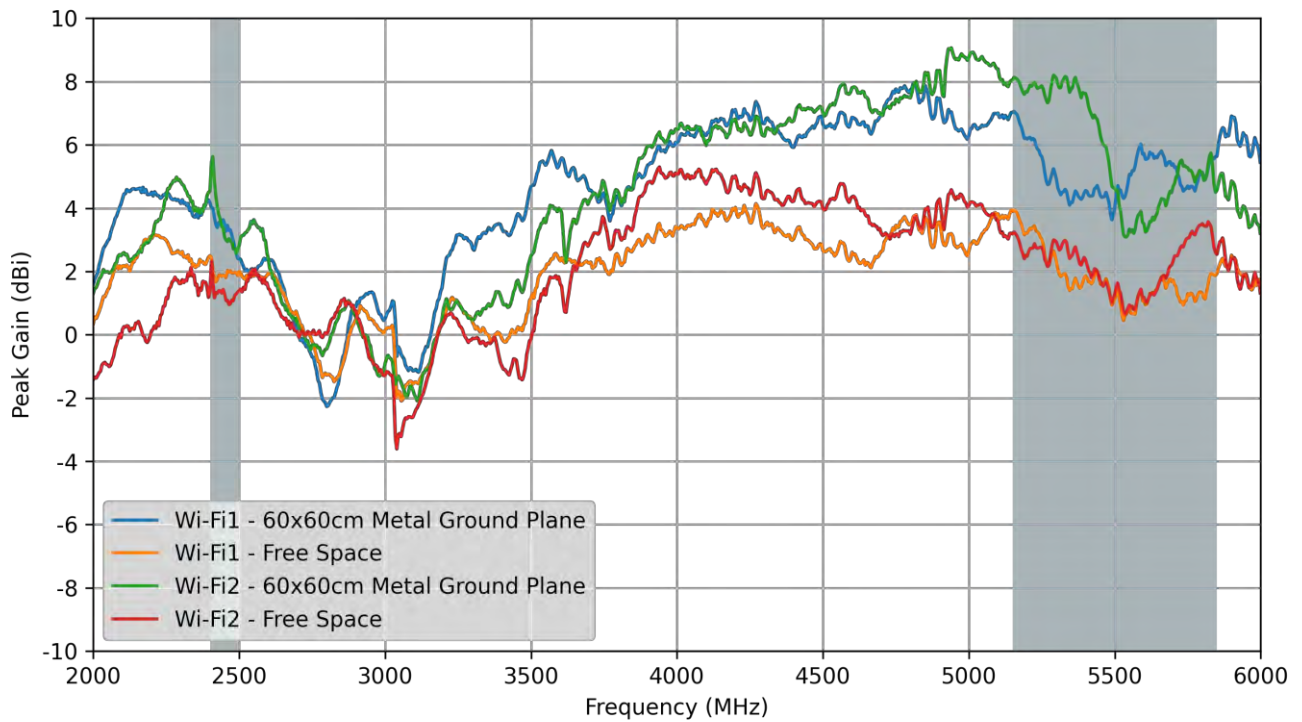

### 4.16 Isolation

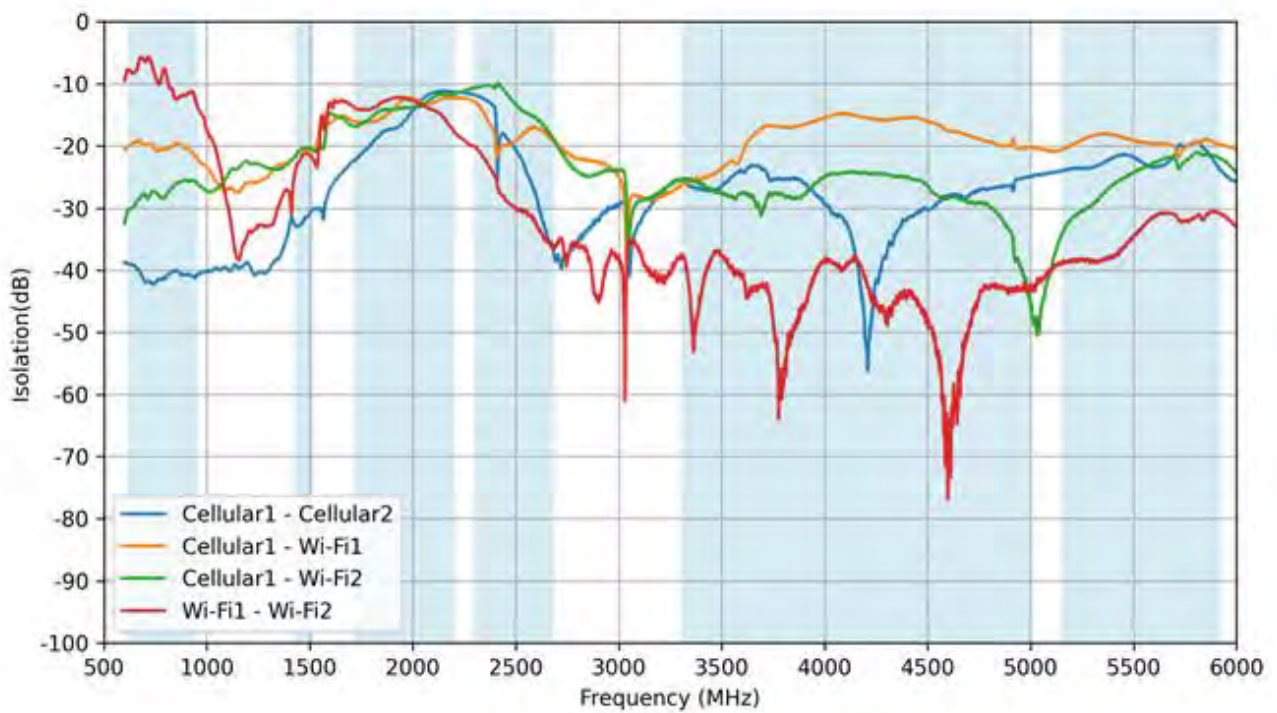



## 5. LNA Characteristics

### 5.1 LNA Gain

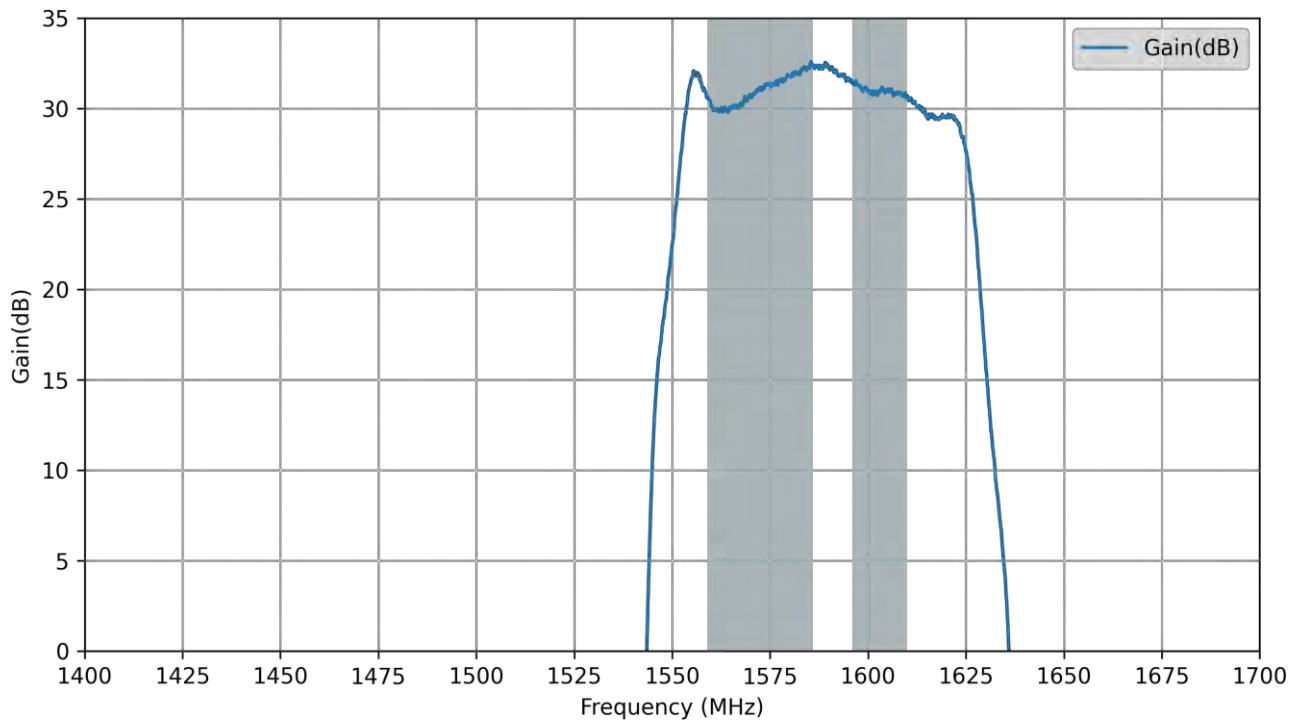

## 6. Radiation Patterns

### 6.1 Test Setup

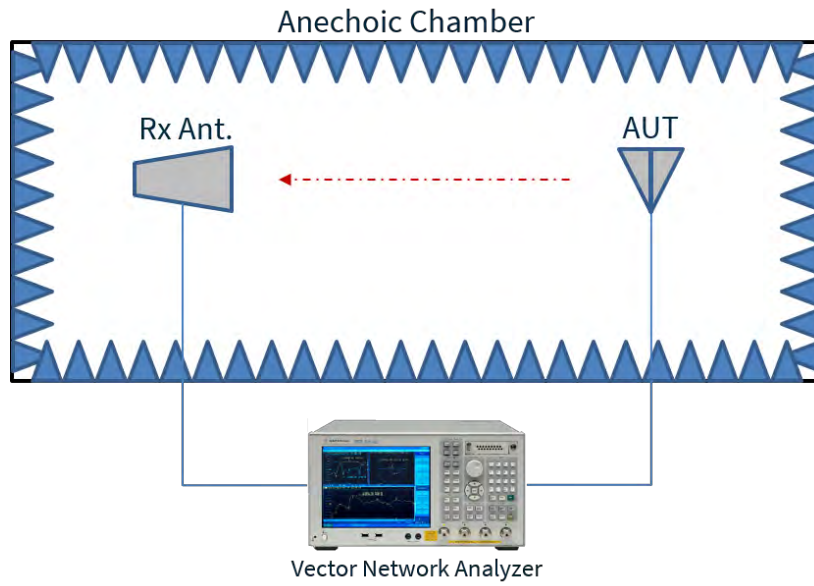

Chamber Test Set-up

## 6.2 GNSS 60x60cm Metal Ground Plane Patterns at 1575 MHz

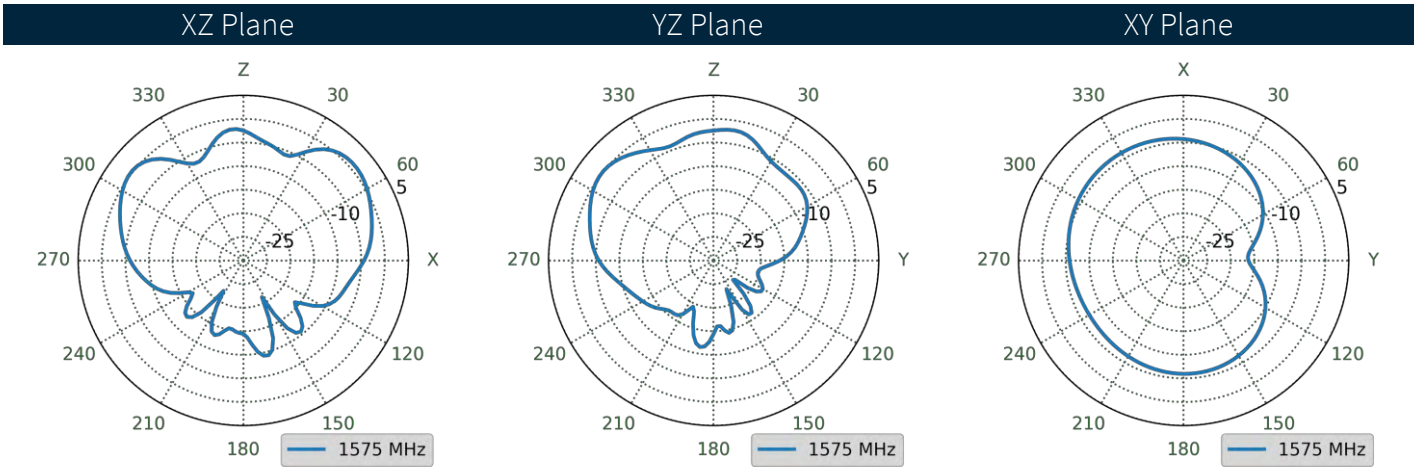
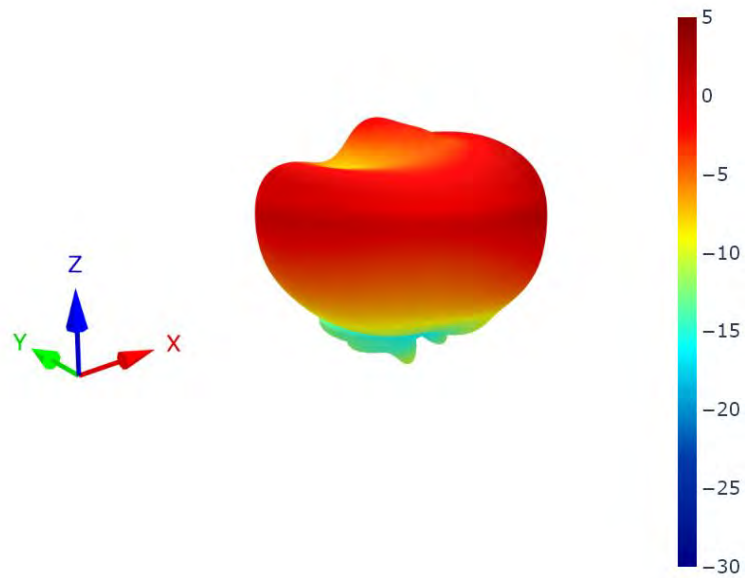

6.3 GNSS Free Space Patterns at 1575 MHz

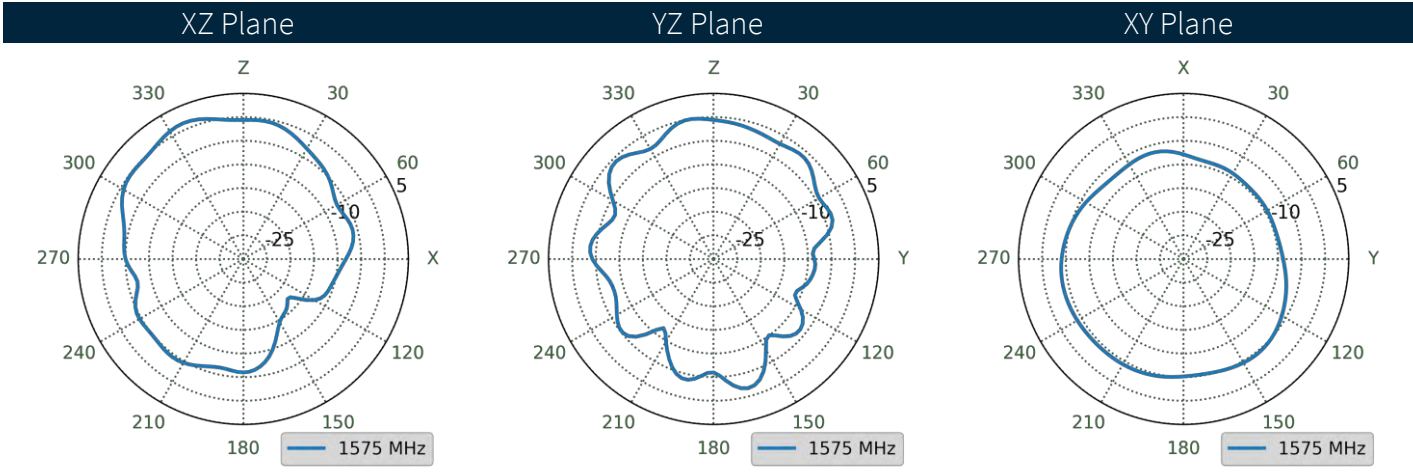
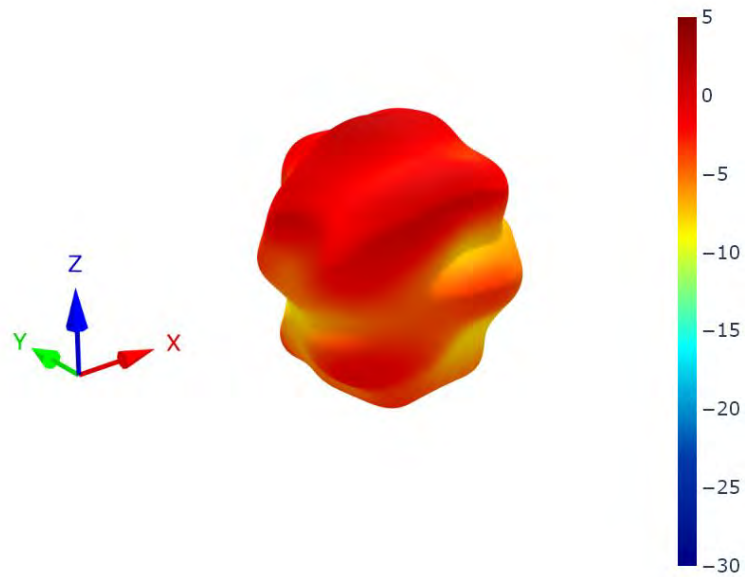

6.4 GNSS 60x60cm Metal Ground Plane Patterns at 1562 MHz

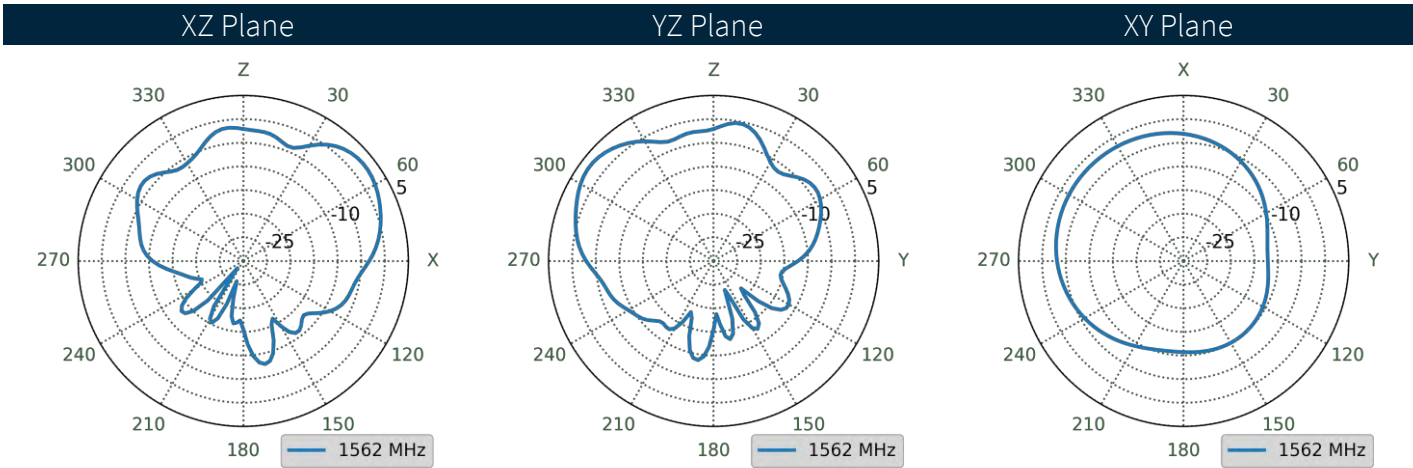
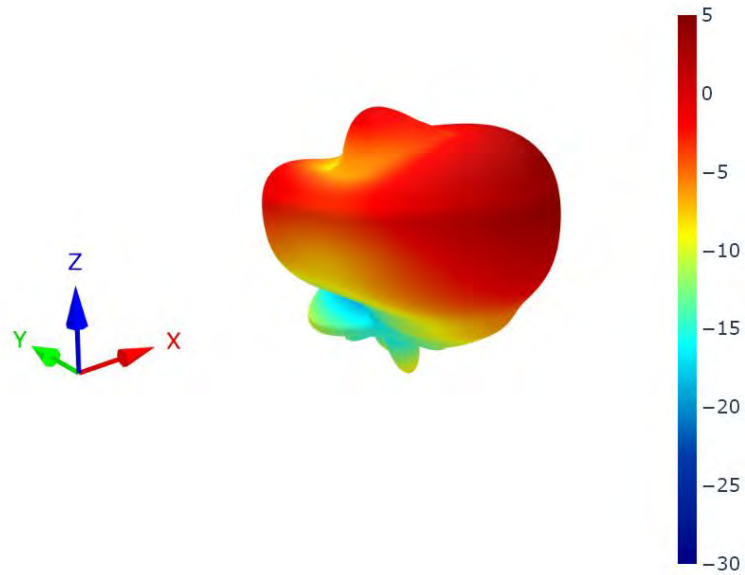

6.5 GNSS Free Space Patterns at 1562 MHz

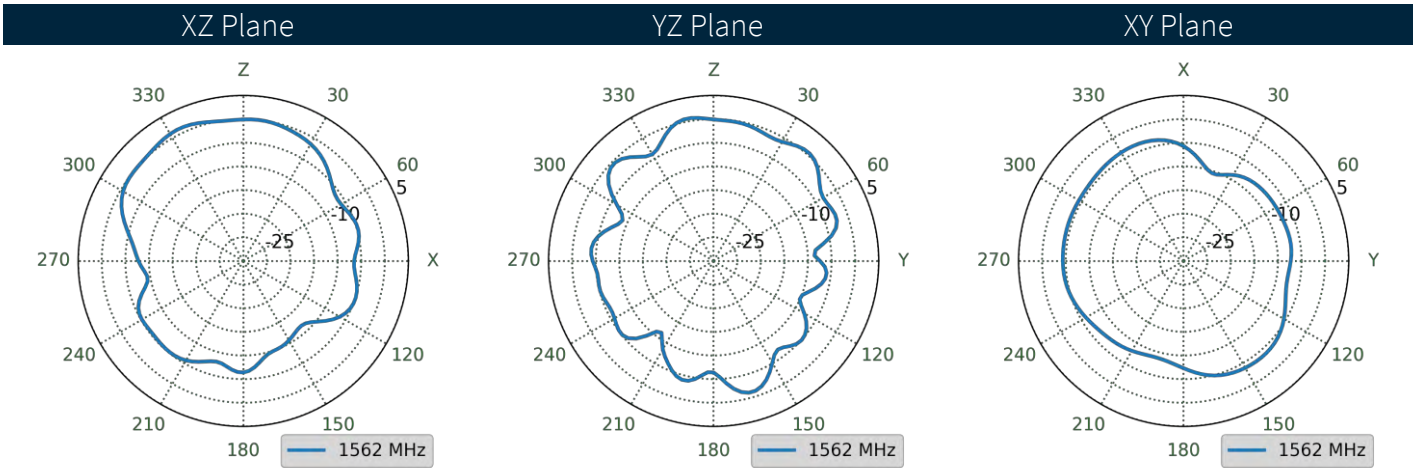
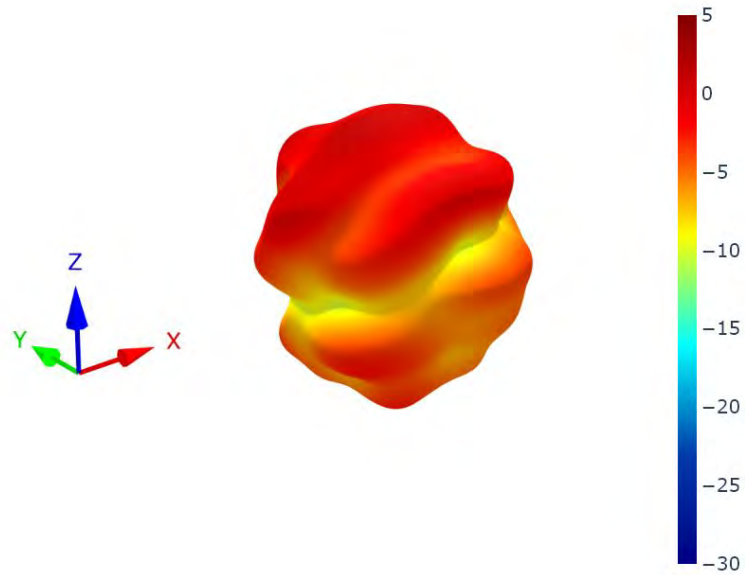

6.6 GNSS 60x60cm Metal Ground Plane Patterns at 1603 MHz

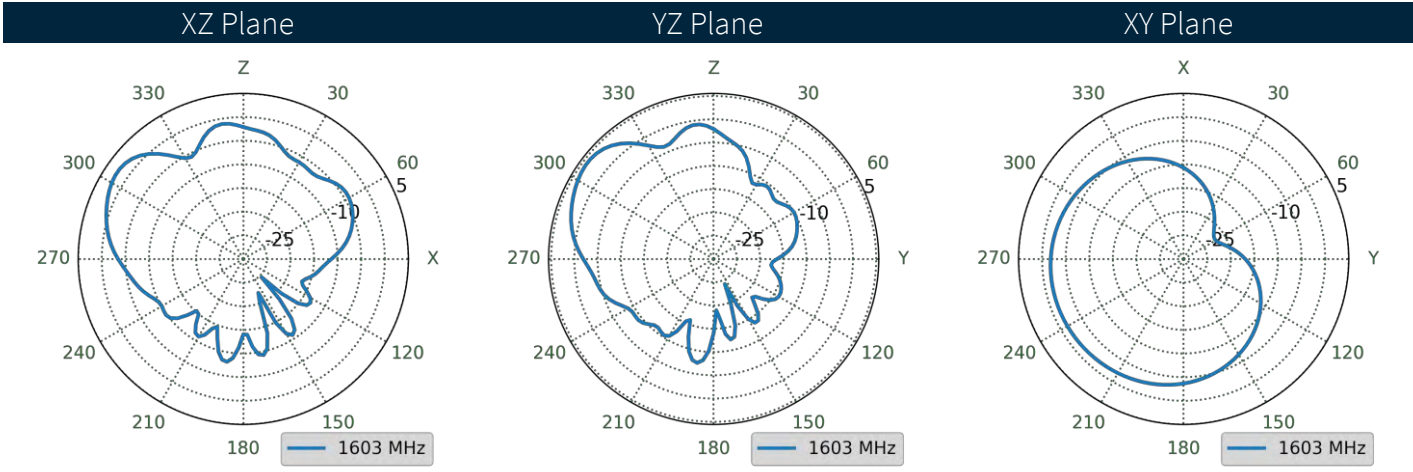
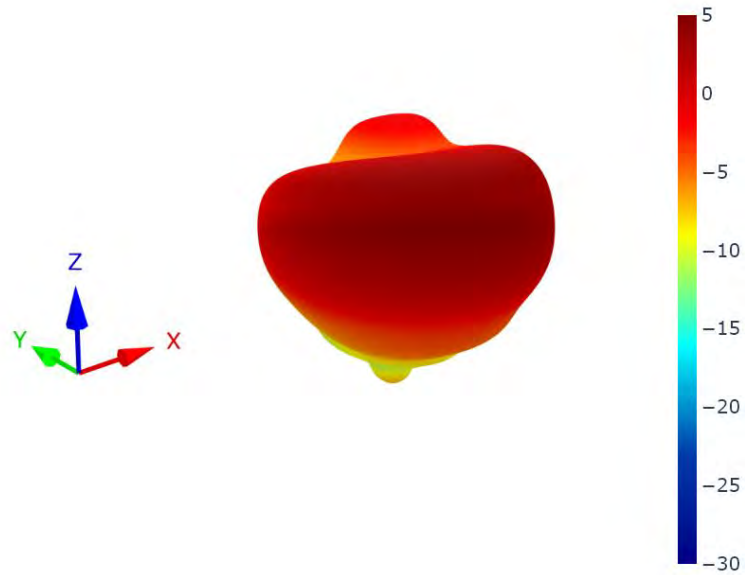

6.7 GNSS Free Space Patterns at 1603 MHz

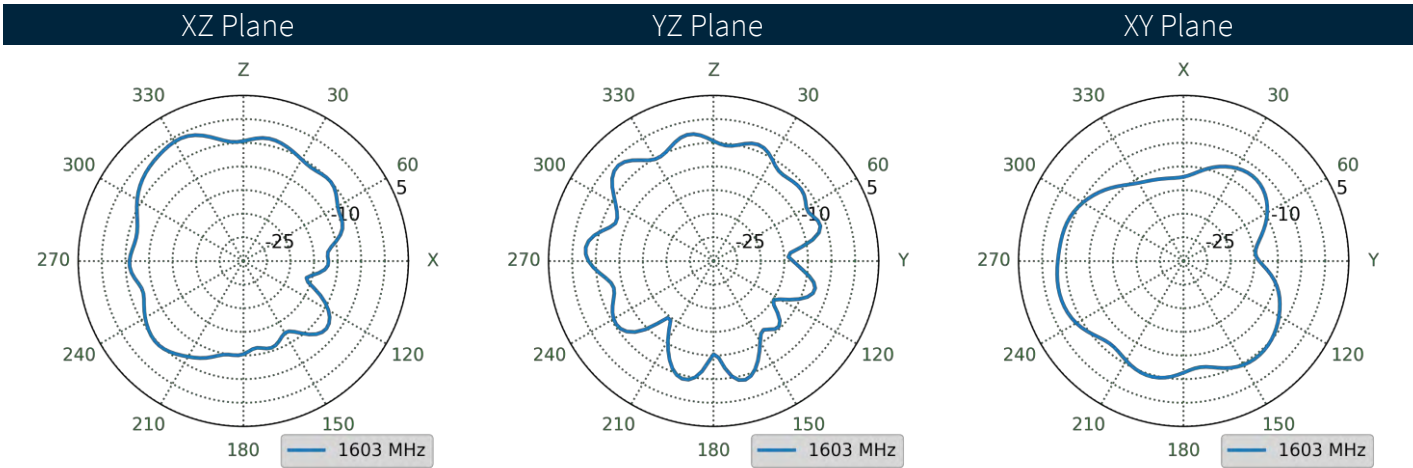
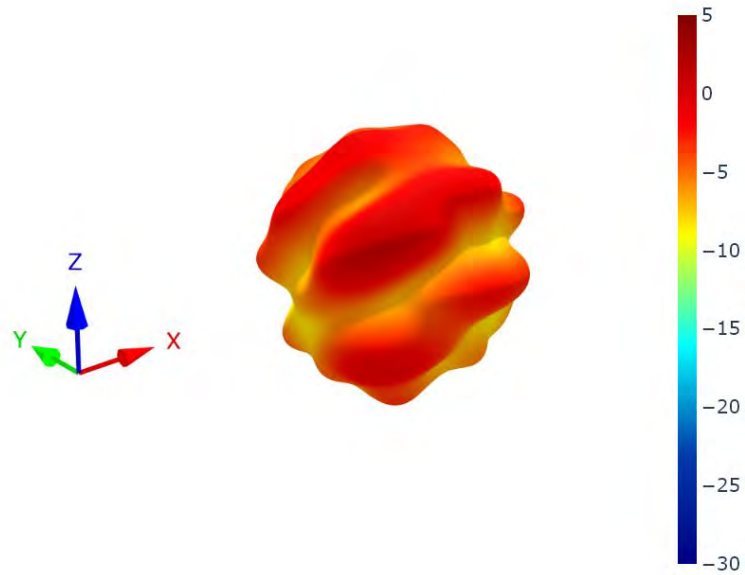



6.8 Cellular1 - 60x60cm Metal Ground Plane Patterns at 655 MHz

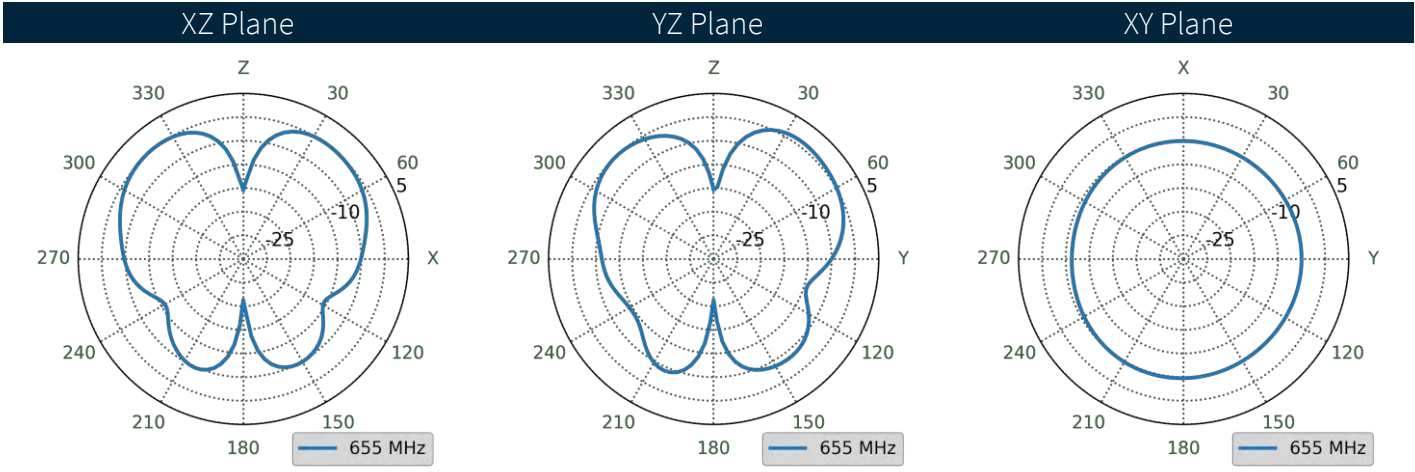
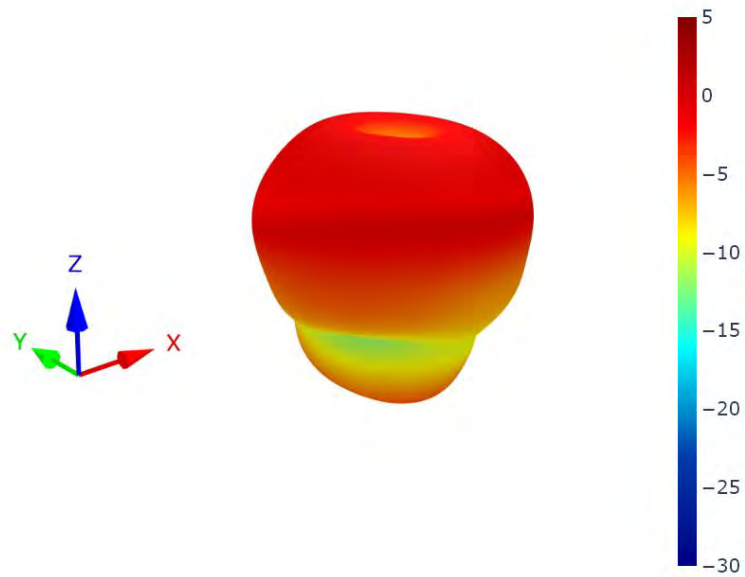

6.9 Cellular1 - Free Space Patterns at 655 MHz

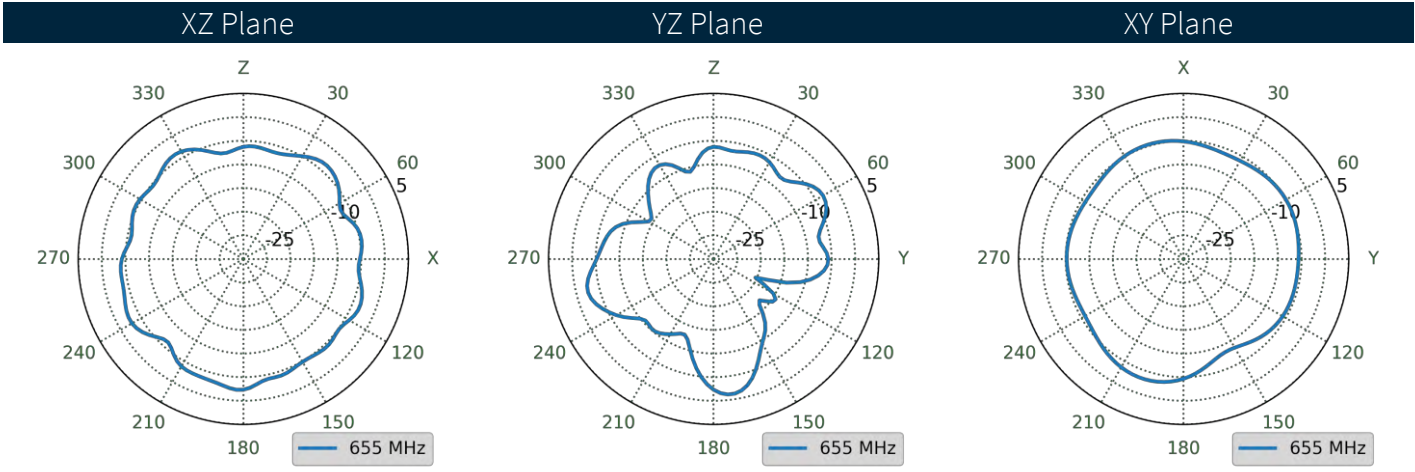
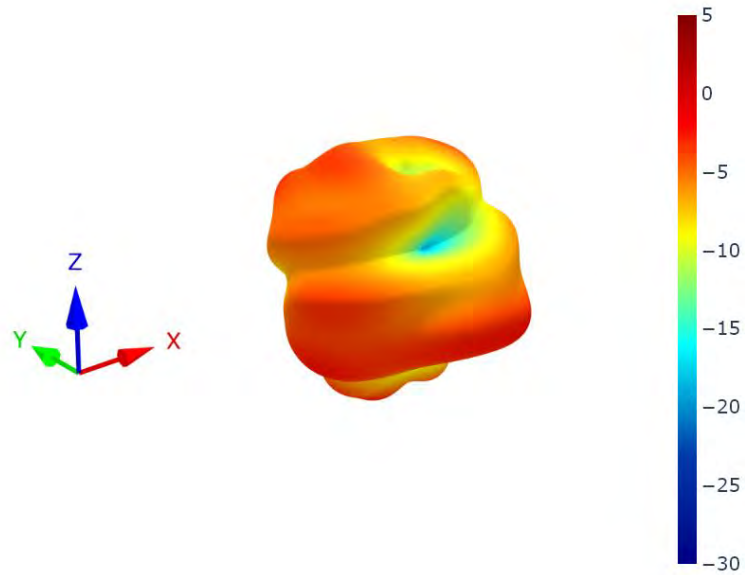

6.10 Cellular2 - 60x60cm Metal Ground Plane Patterns at 655 MHz

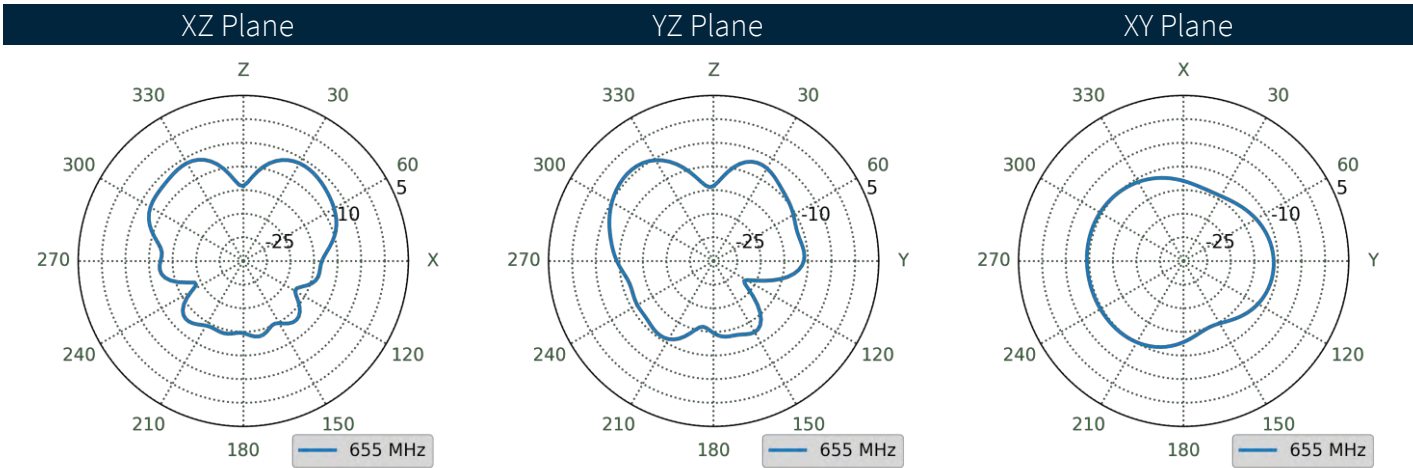
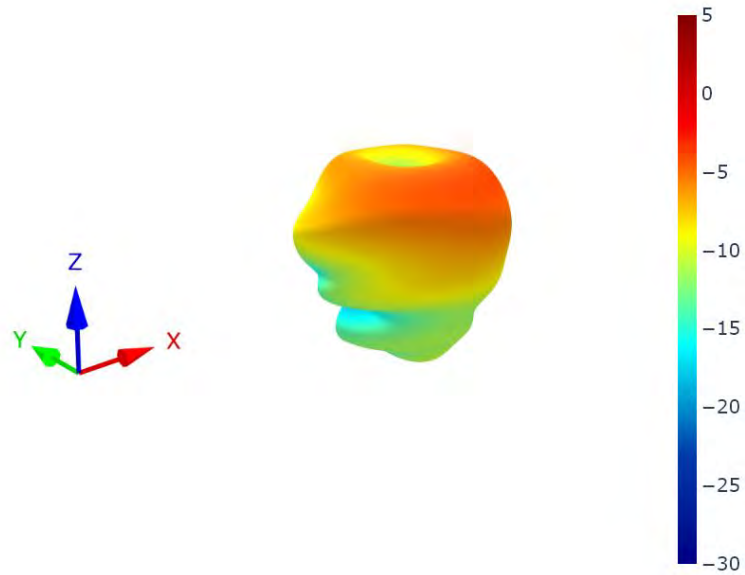

6.11 Cellular2 - Free Space Patterns at 655 MHz

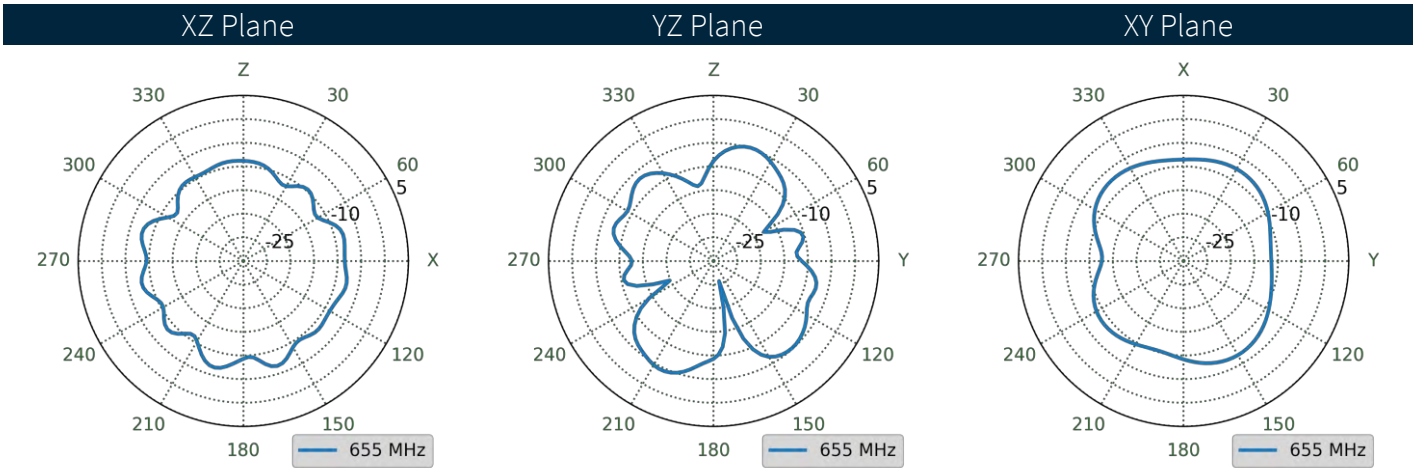
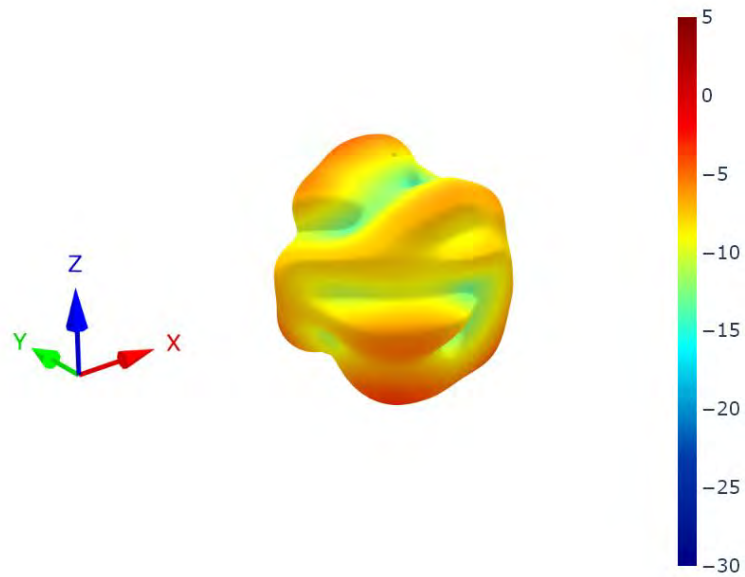

6.12 Cellular1 - 60x60cm Metal Ground Plane Patterns at 750 MHz

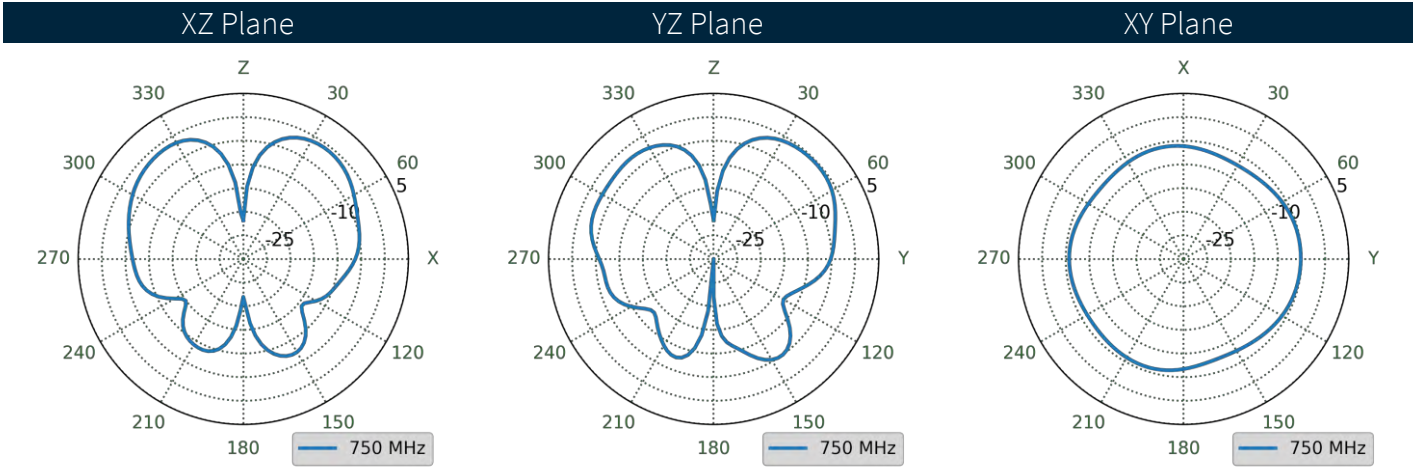
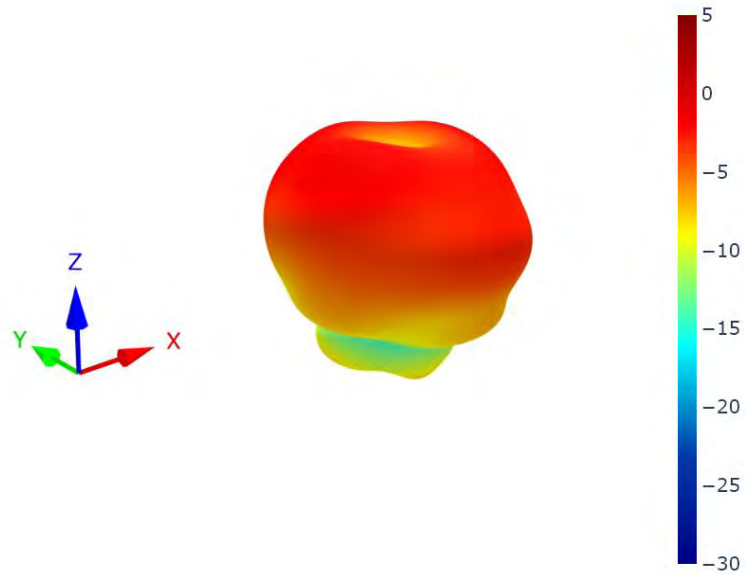

6.13 Cellular1 - Free Space Patterns at 750 MHz

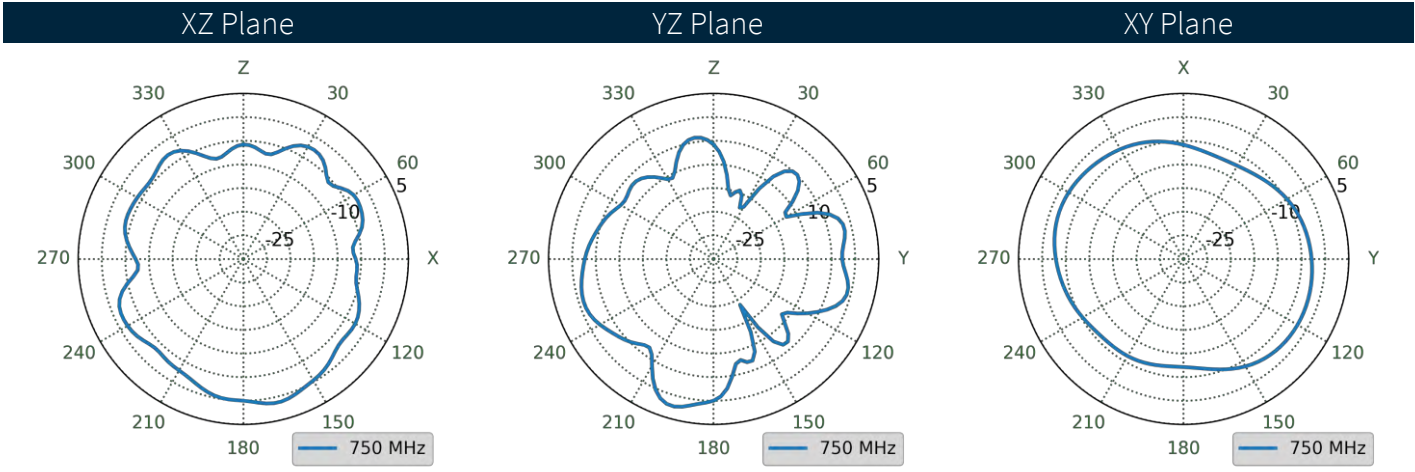
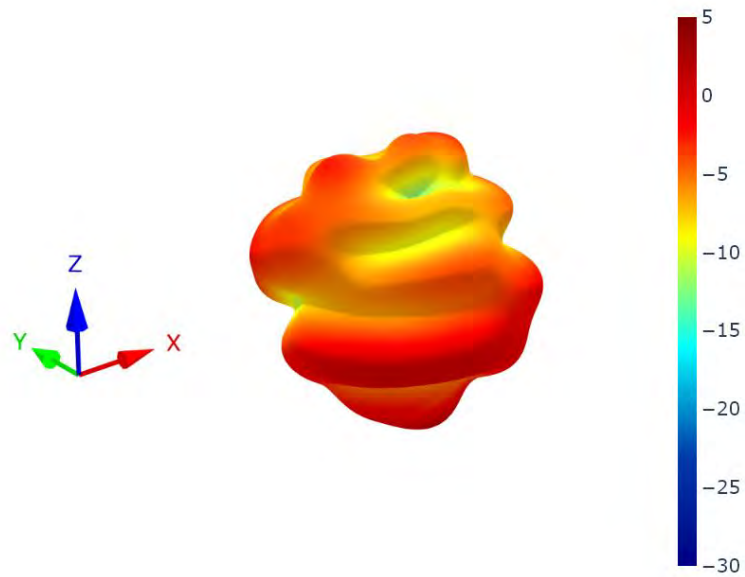

6.14 Cellular2 - 60x60cm Metal Ground Plane Patterns at 750 MHz

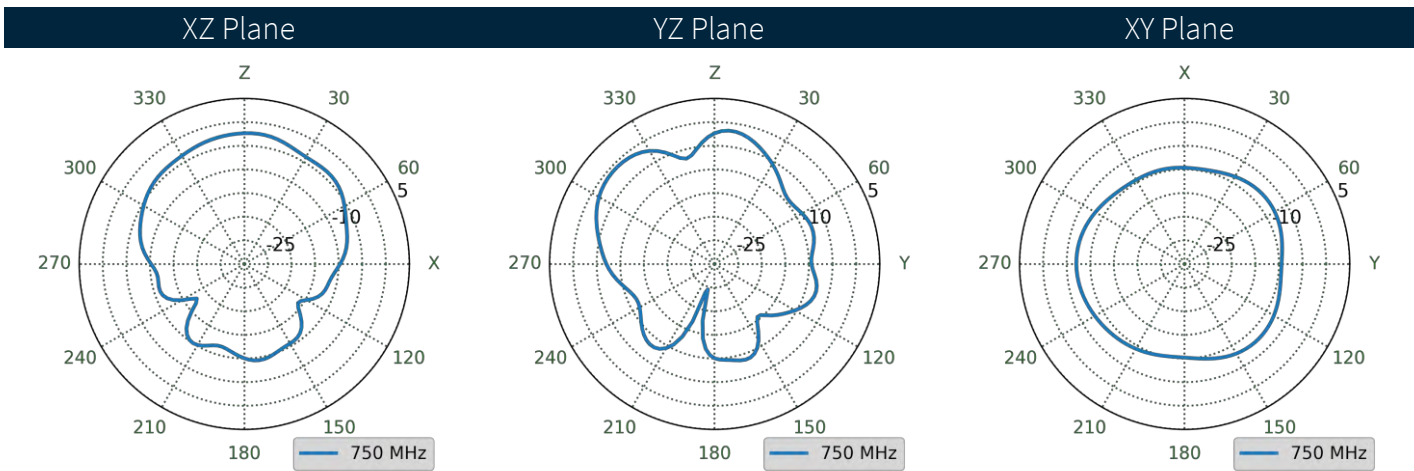
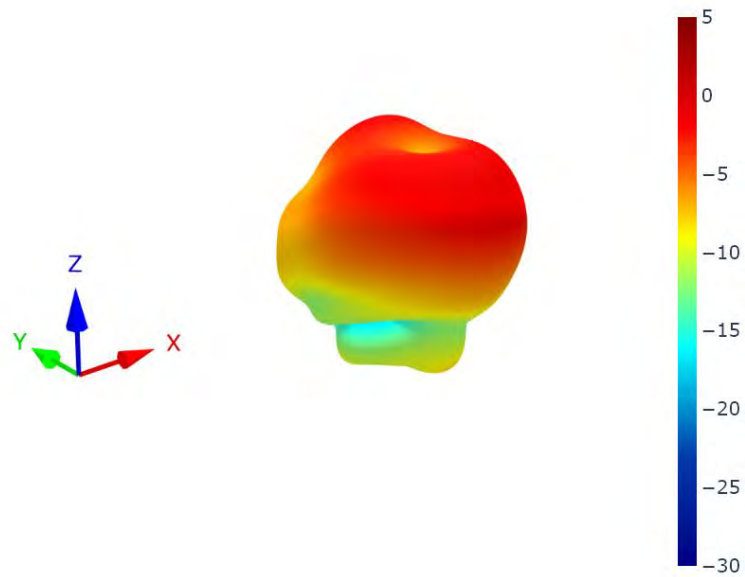

6.15 Cellular2 - Free Space Patterns at 750 MHz

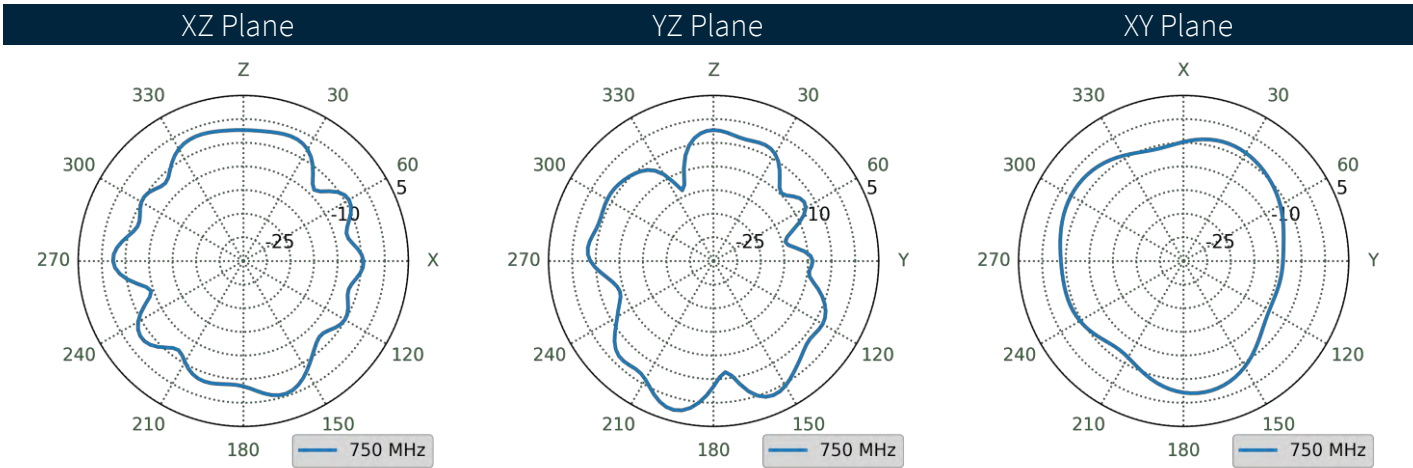
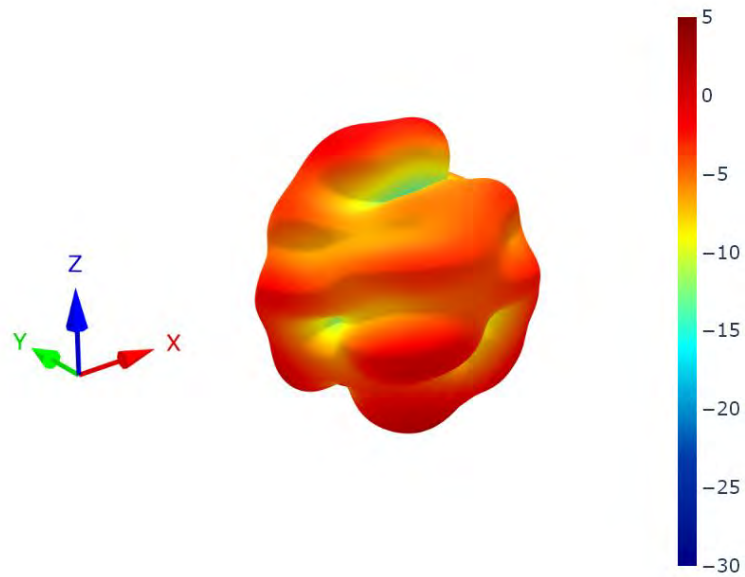



6.16 Cellular1 - 60x60cm Metal Ground Plane Patterns at 890 MHz

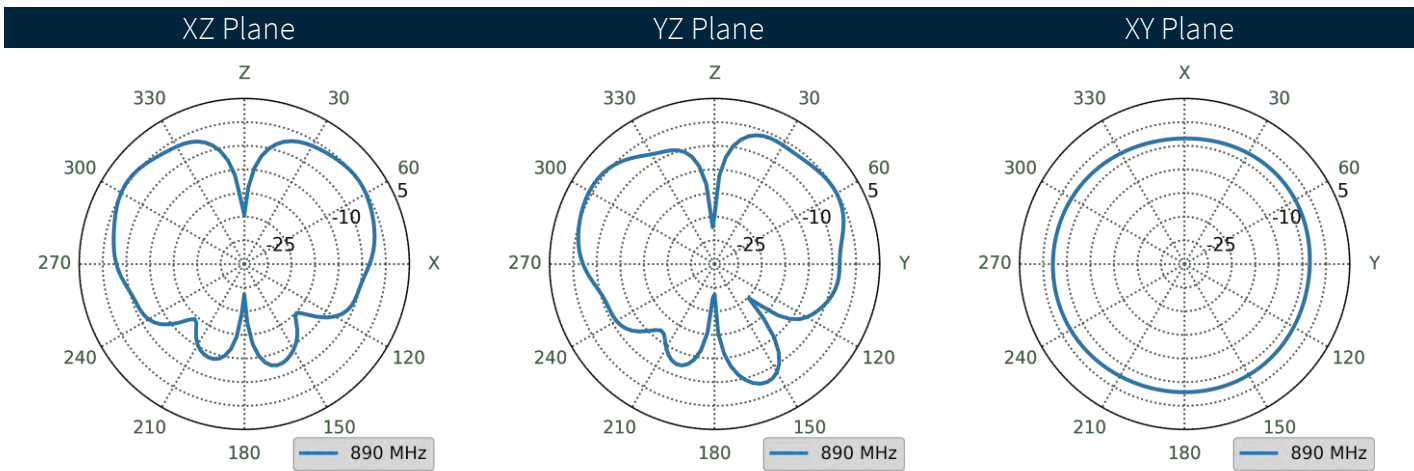
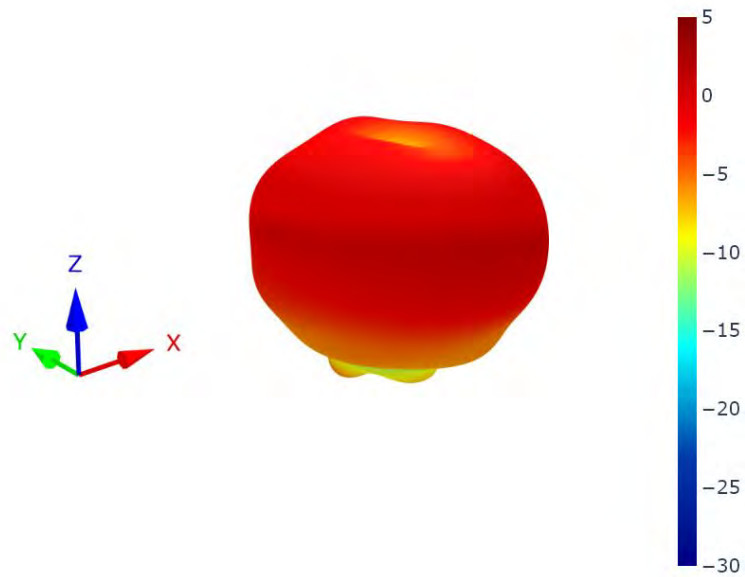

6.17 Cellular1 - Free Space Patterns at 890 MHz

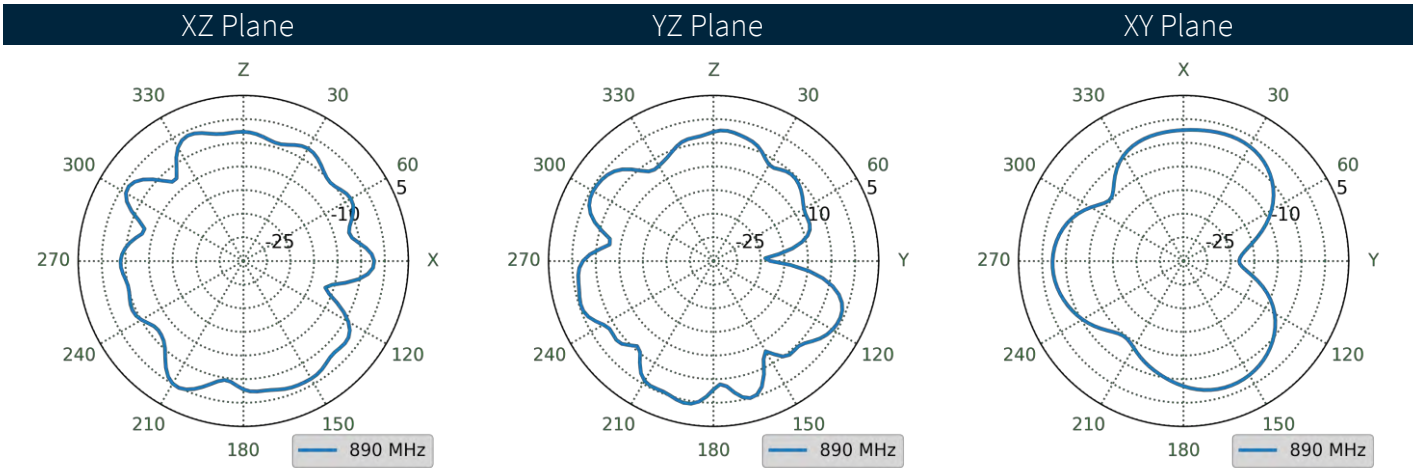
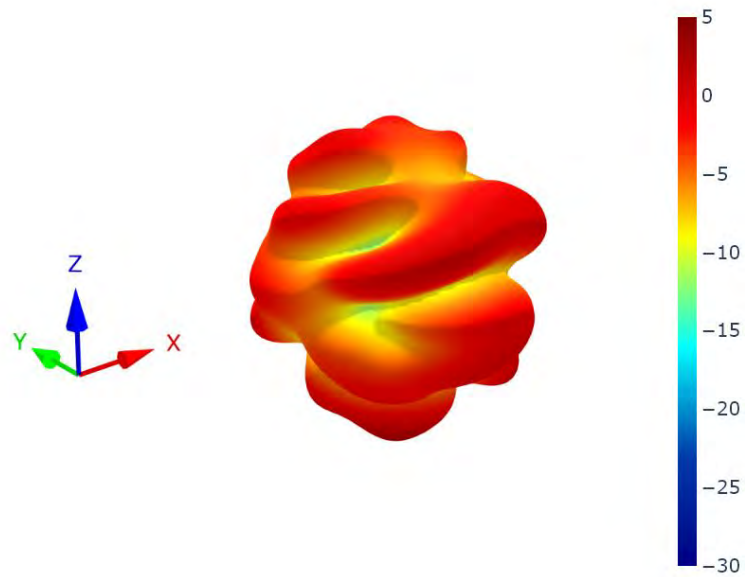

6.18 Cellular2 - 60x60cm Metal Ground Plane Patterns at 890 MHz

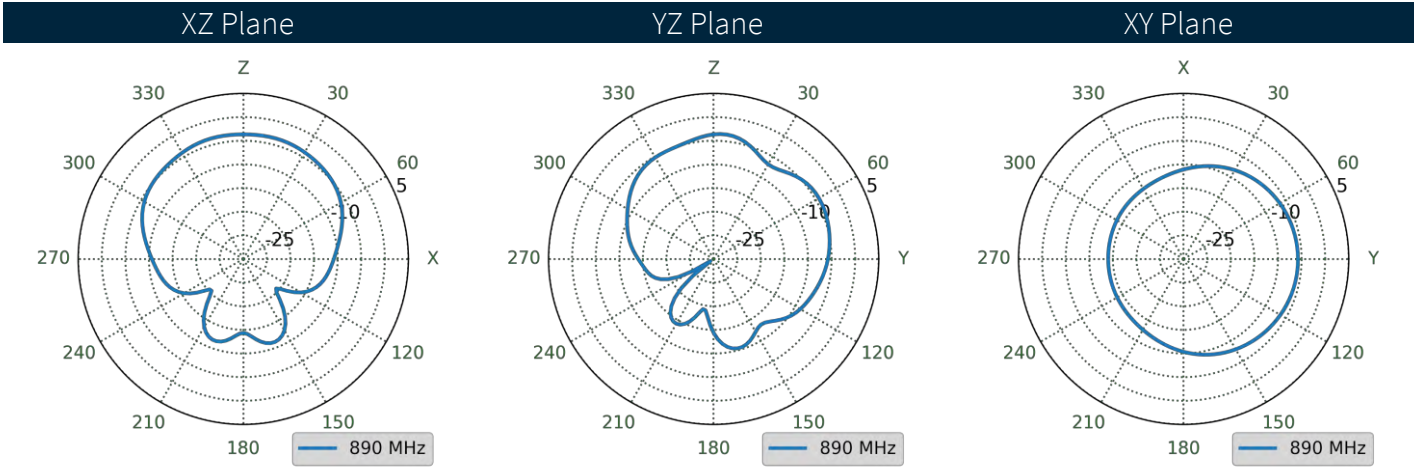
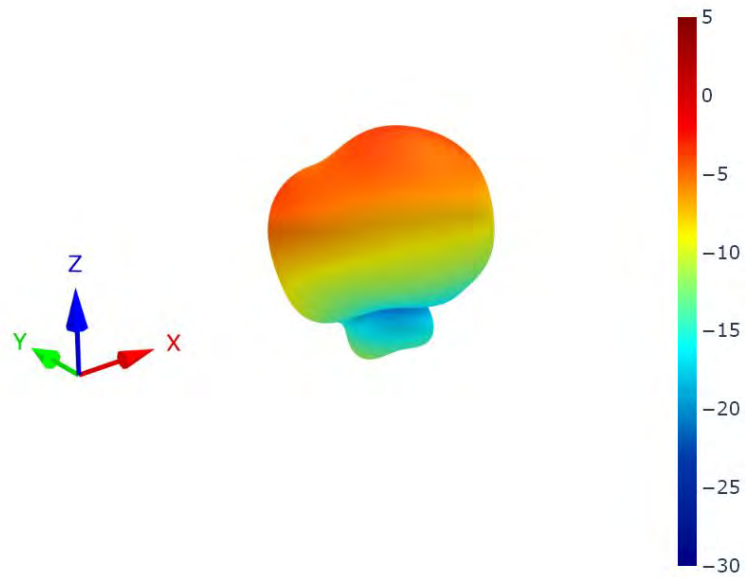

6.19 Cellular2 - Free Space Patterns at 890 MHz

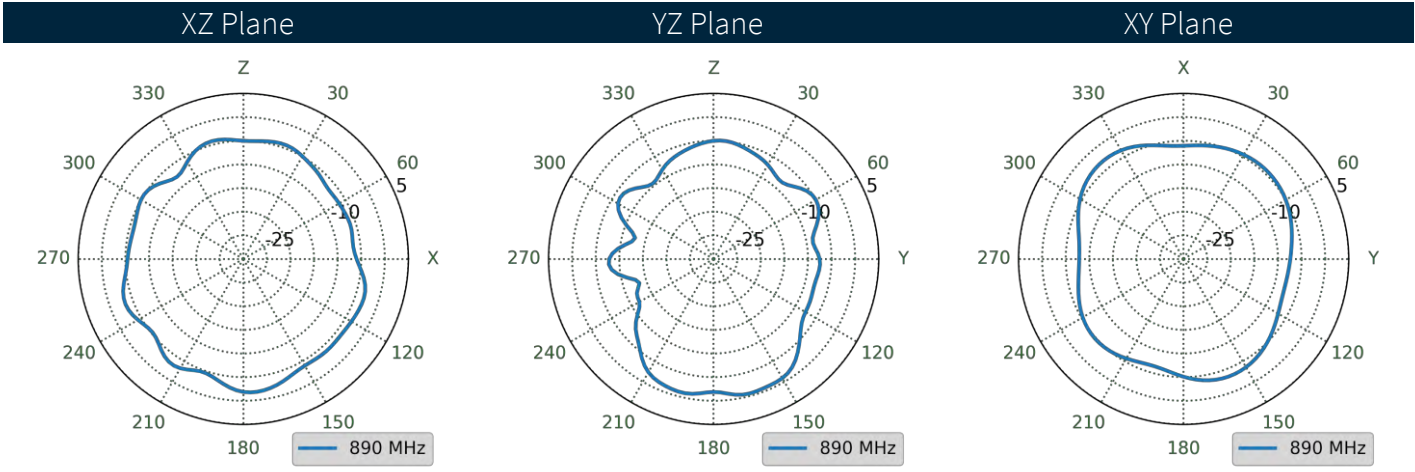
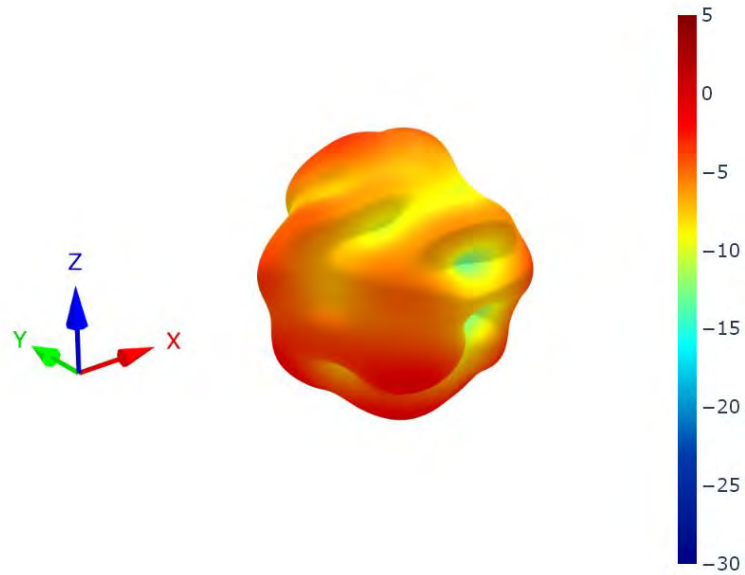

6.20 Cellular1 - 60x60cm Metal Ground Plane Patterns at 1470 MHz

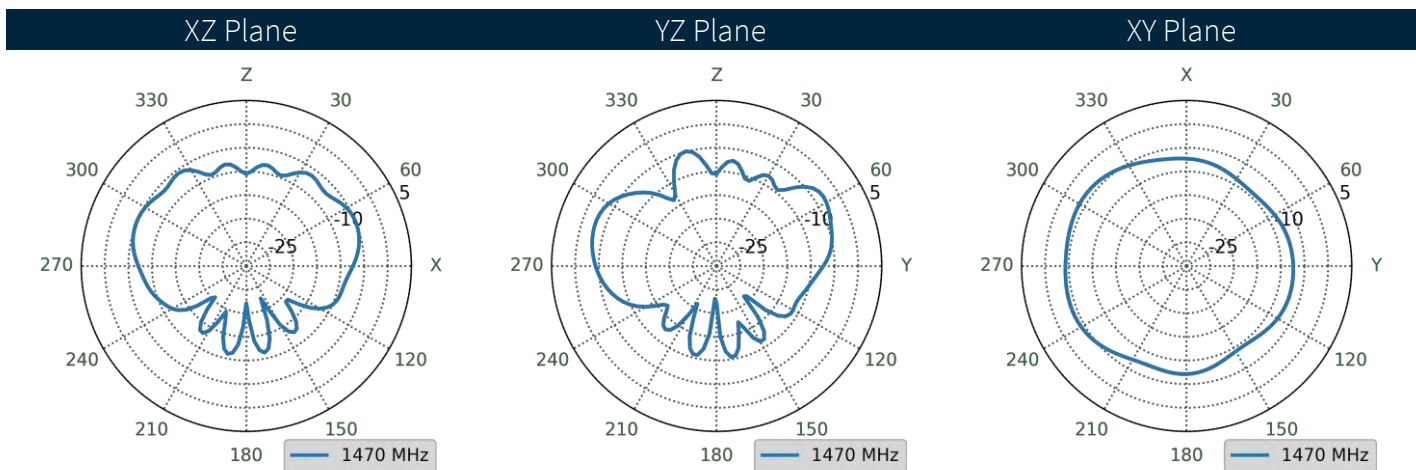
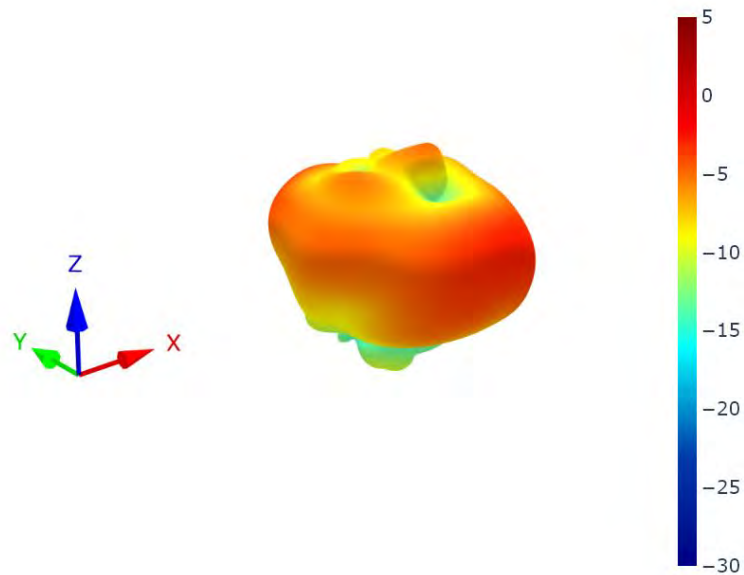

6.21 Cellular1 - Free Space Patterns at 1470 MHz

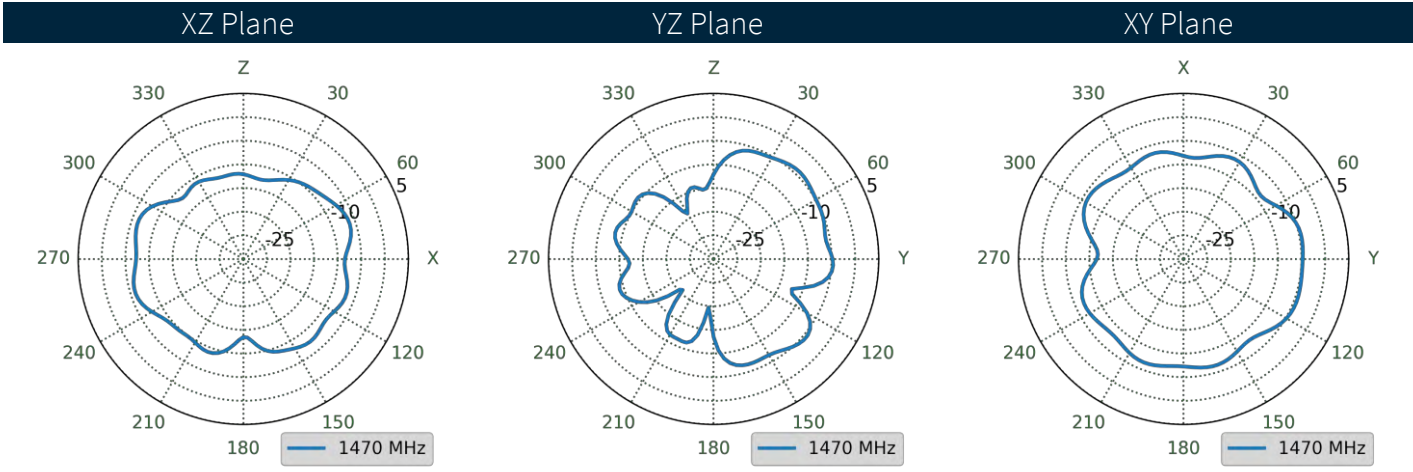
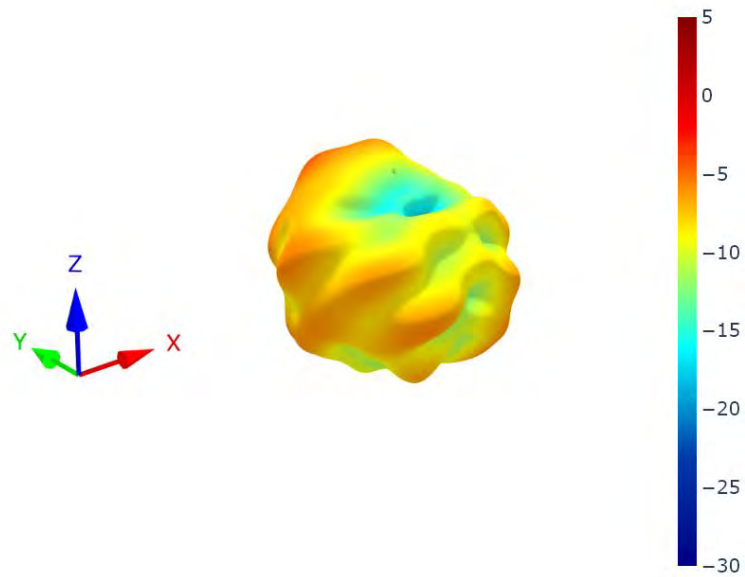

6.22 Cellular2 - 60x60cm Metal Ground Plane Patterns at 1470 MHz

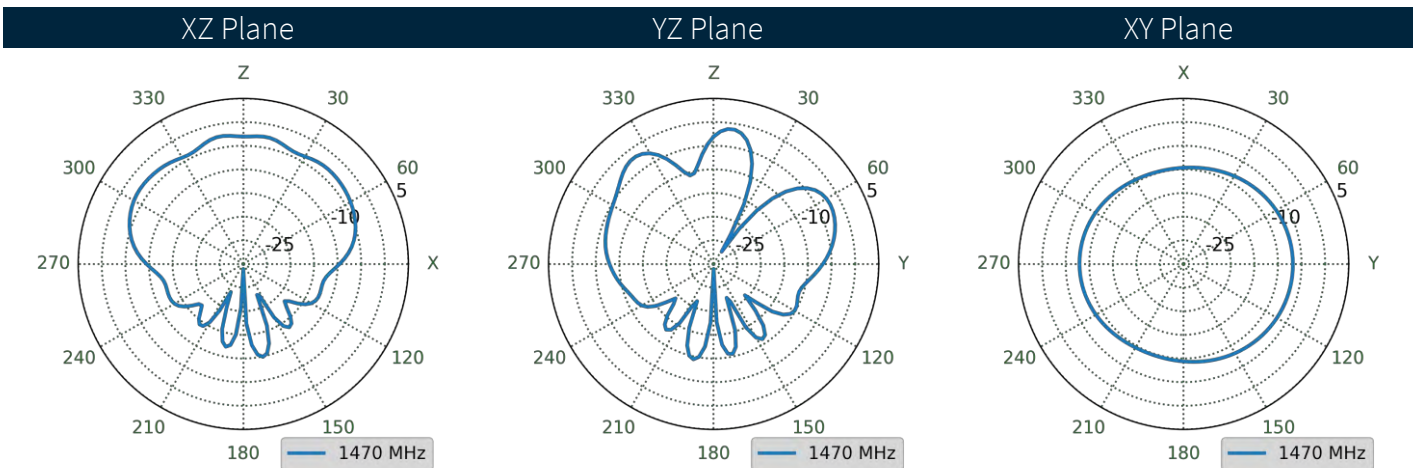
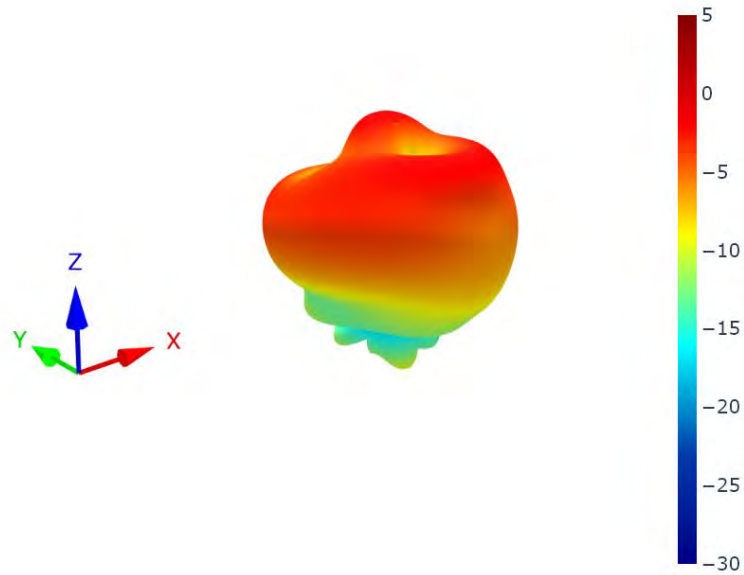

6.23 Cellular2 - Free Space Patterns at 1470 MHz

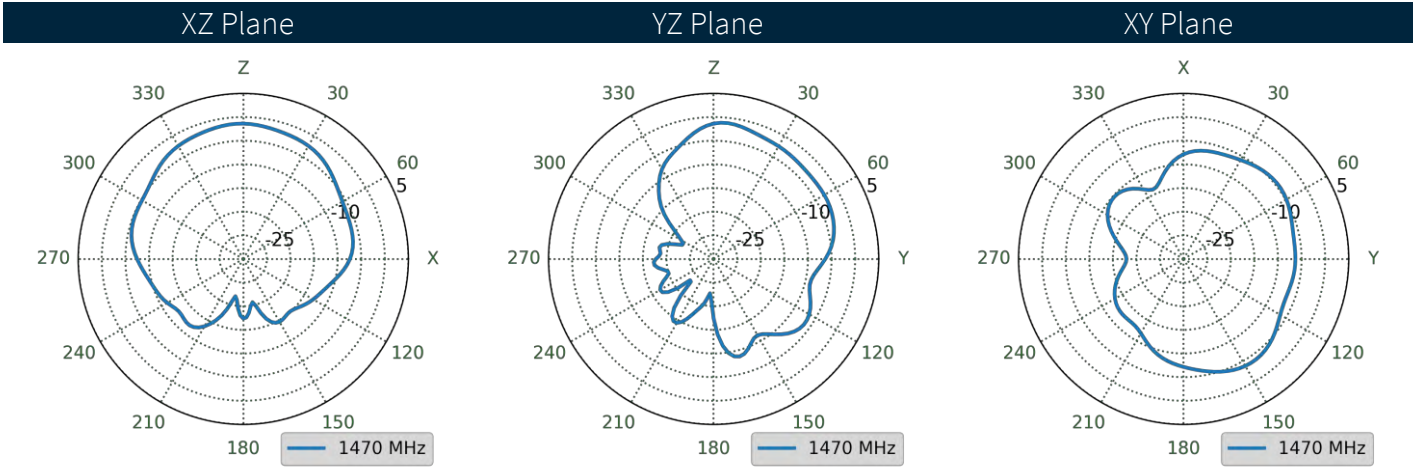
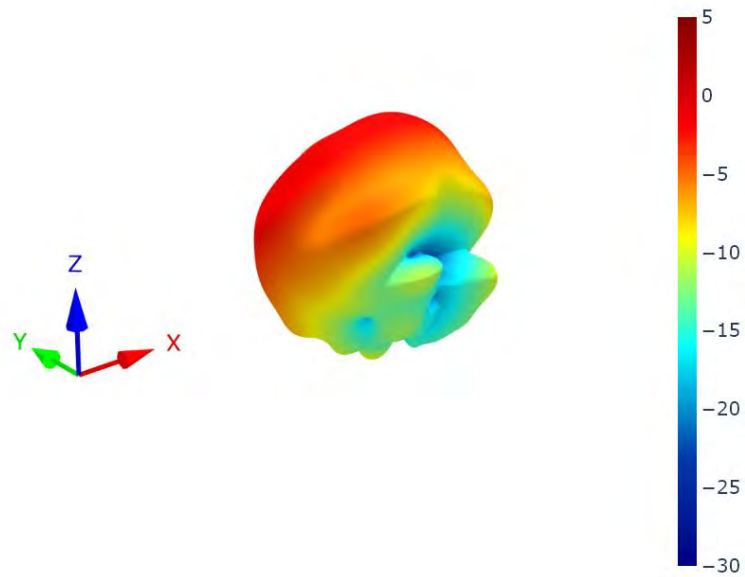



6.24 Cellular1 - 60x60cm Metal Ground Plane Patterns at 1955 MHz

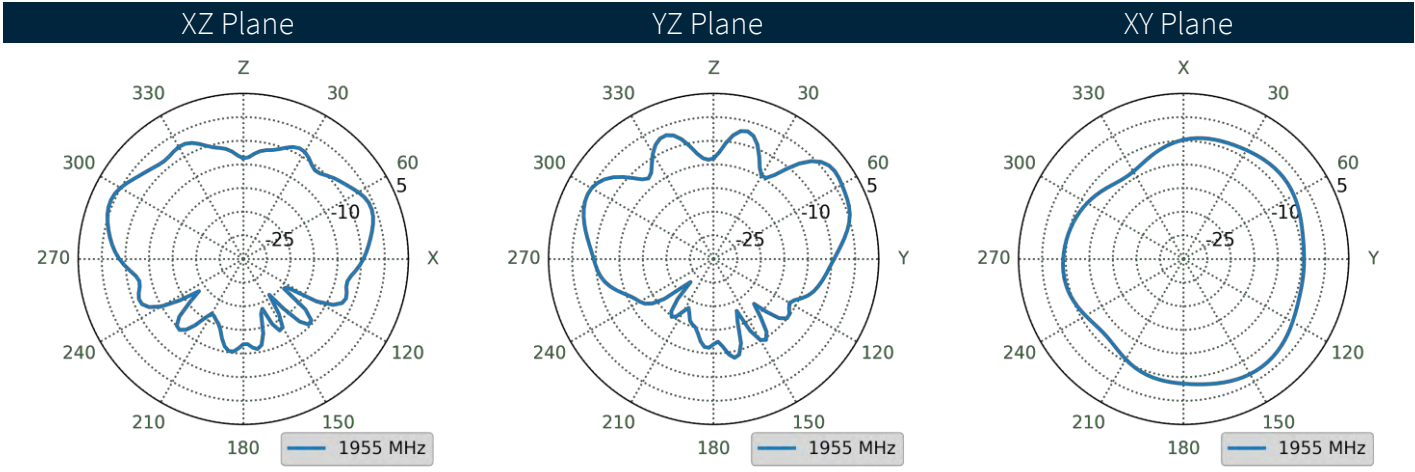
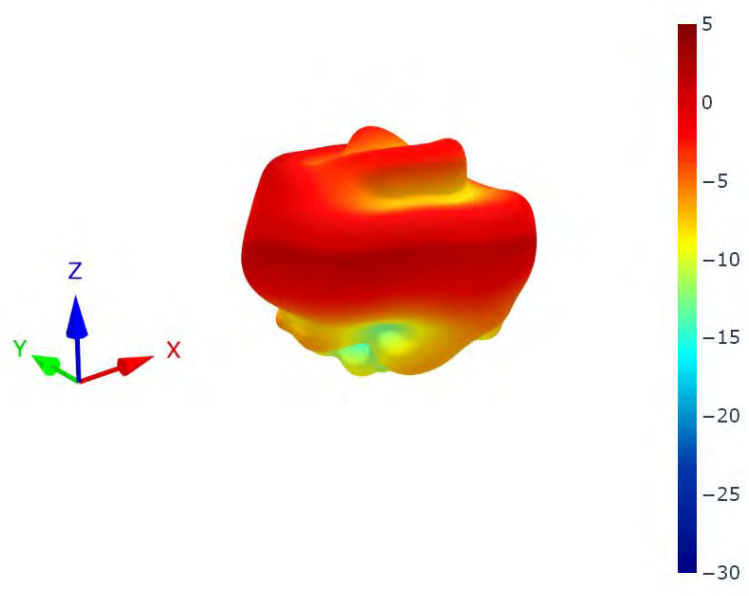

6.25 Cellular1 - Free Space Patterns at 1955 MHz

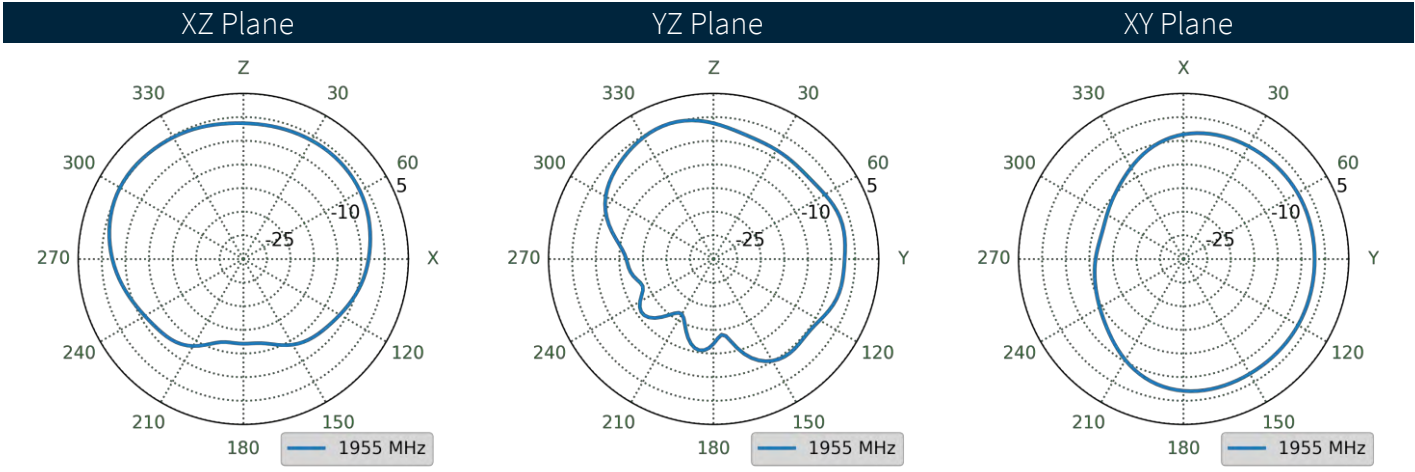
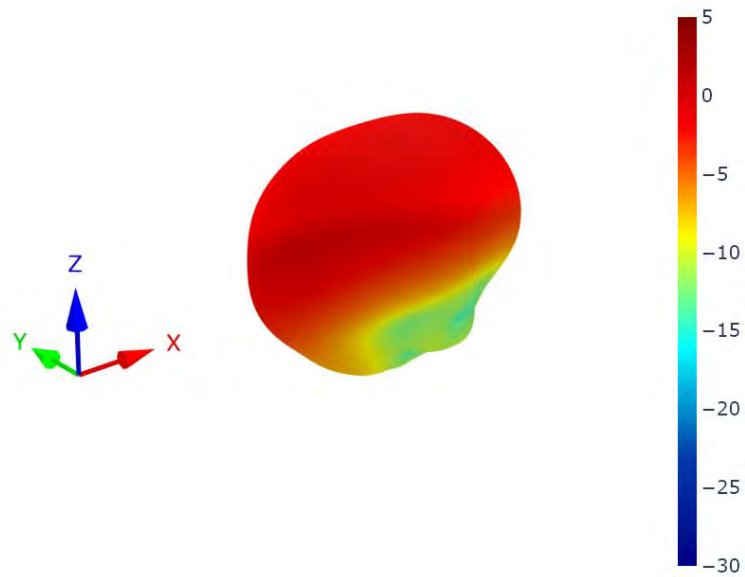

6.26 Cellular2 - 60x60cm Metal Ground Plane Patterns at 1955 MHz

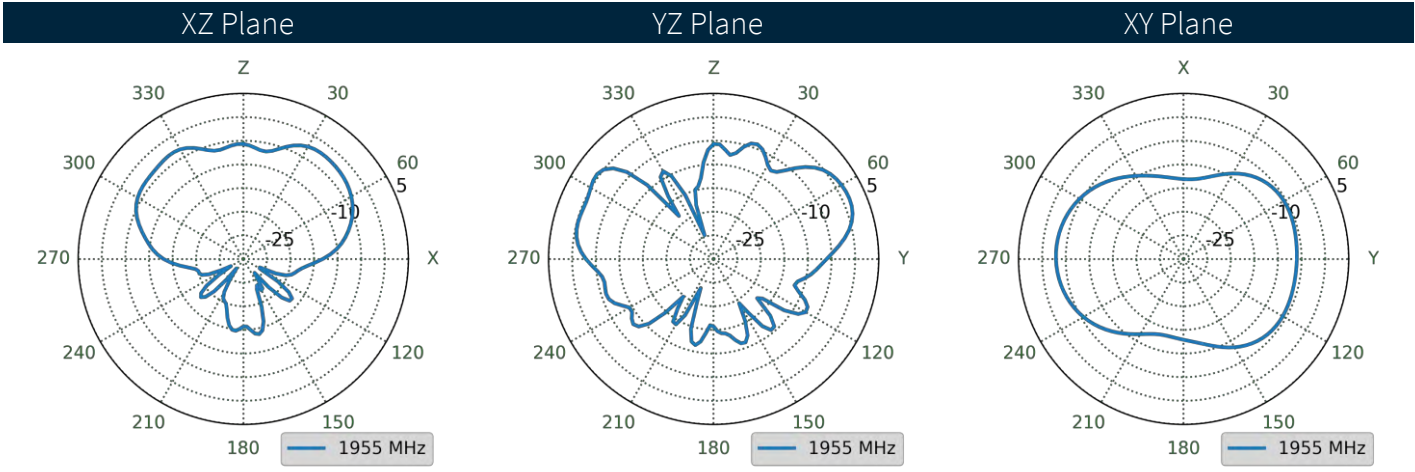
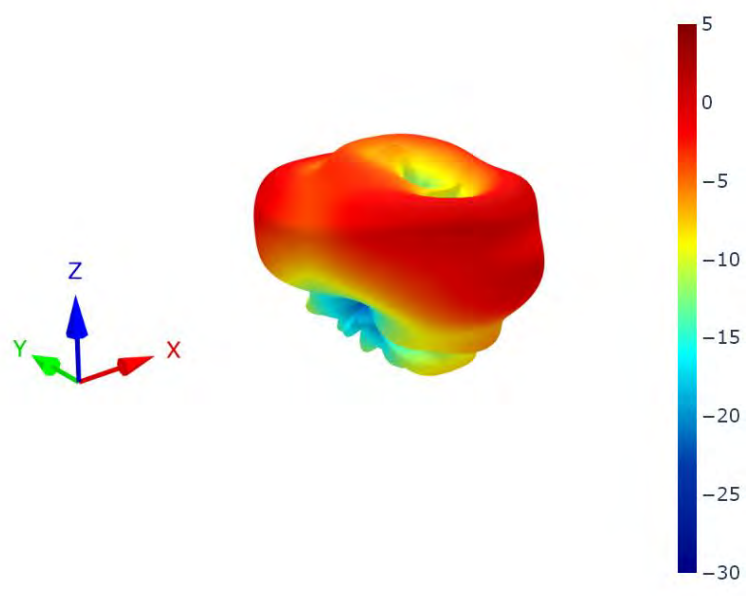

6.27 Cellular2 - Free Space Patterns at 1955 MHz

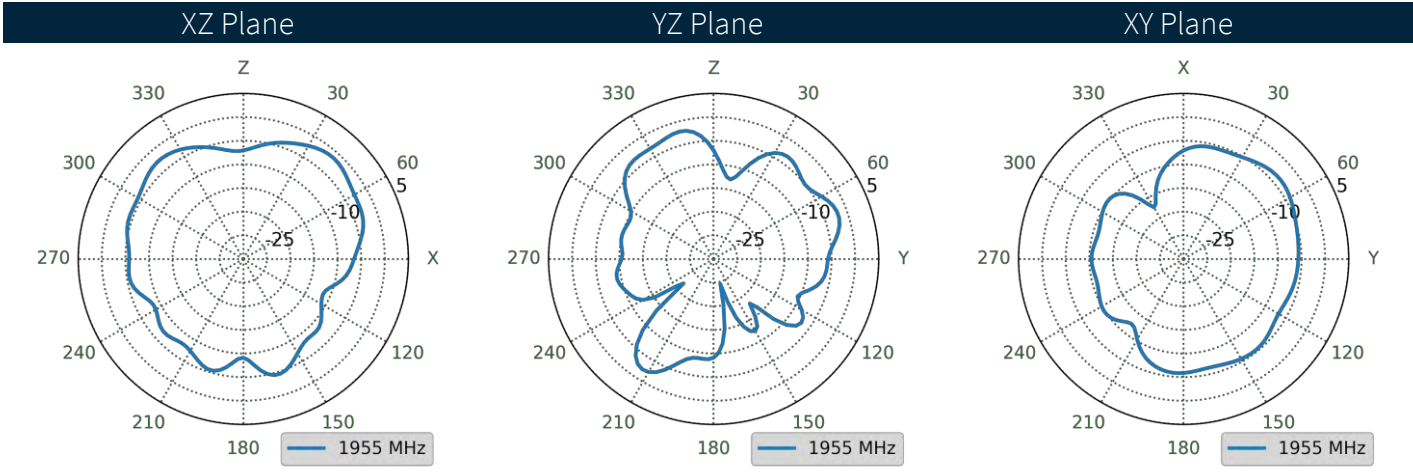
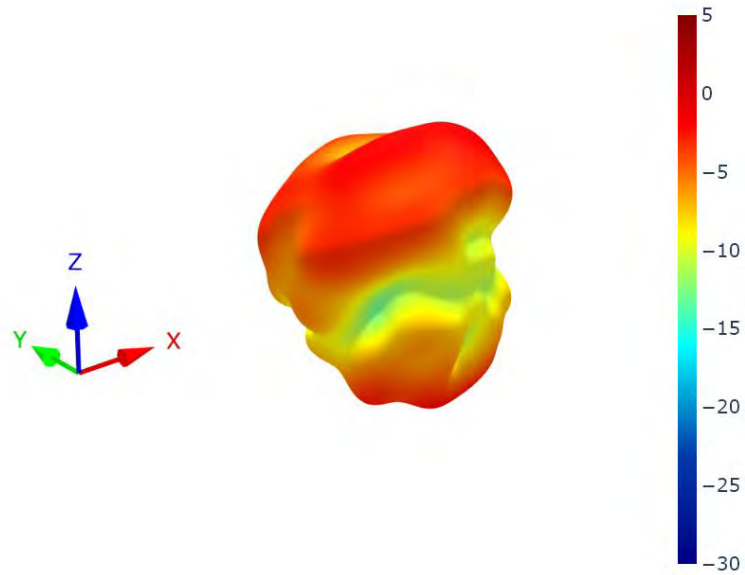

6.28 Cellular1 - 60x60cm Metal Ground Plane Patterns at 2495 MHz

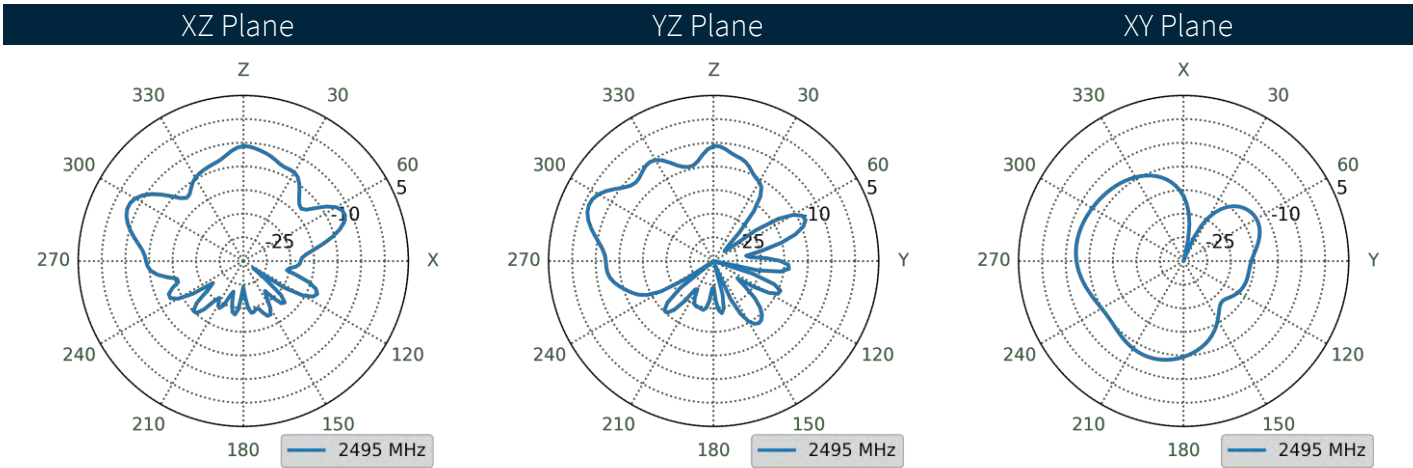
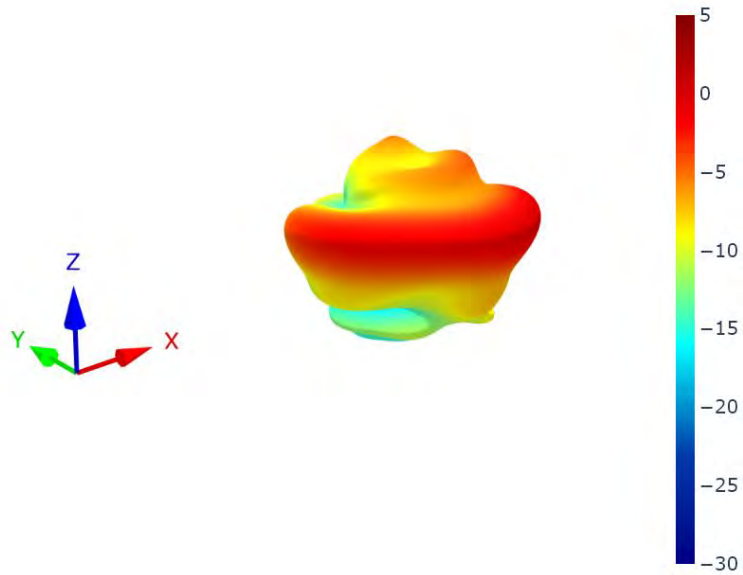

6.29 Cellular1 - Free Space Patterns at 2495 MHz

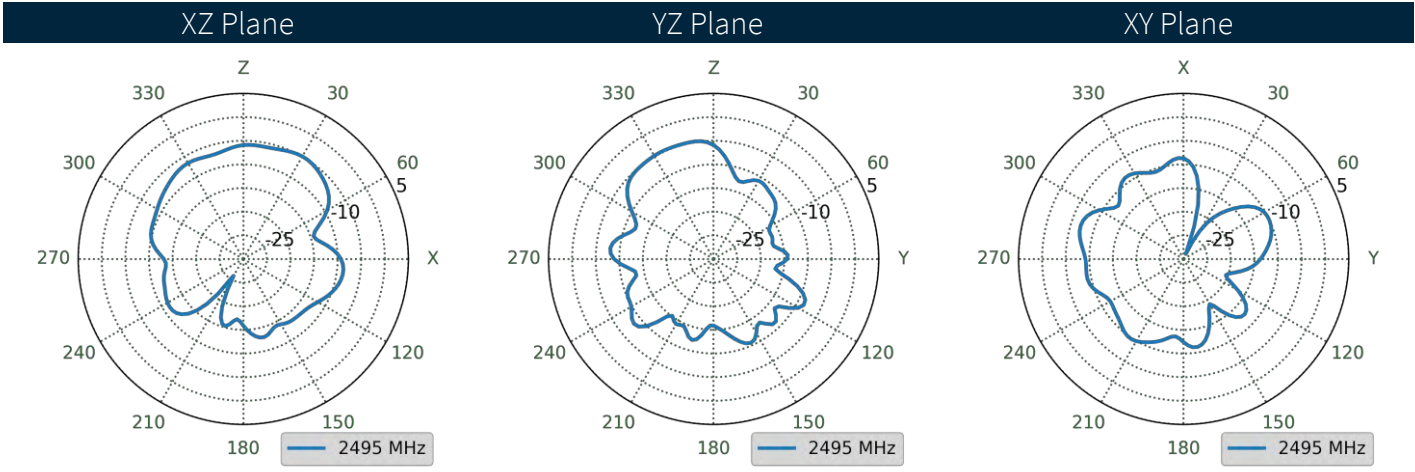
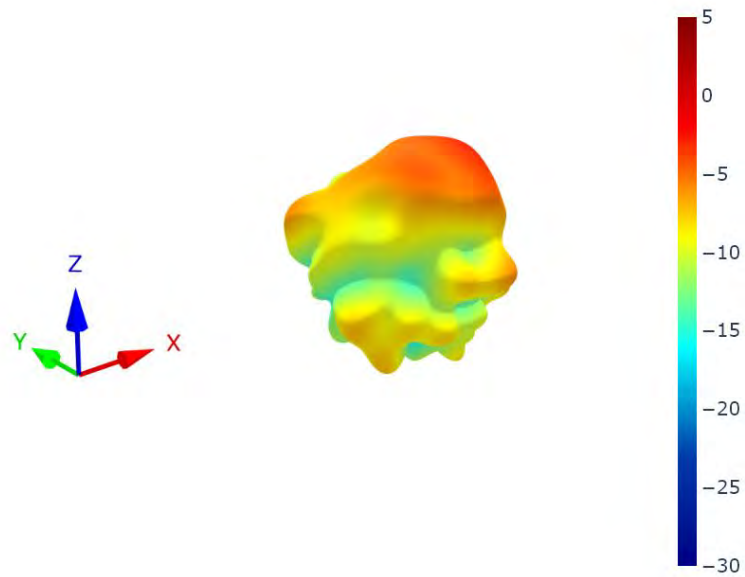

## 6.30 Cellular2 - 60x60cm Metal Ground Plane Patterns at 2495 MHz

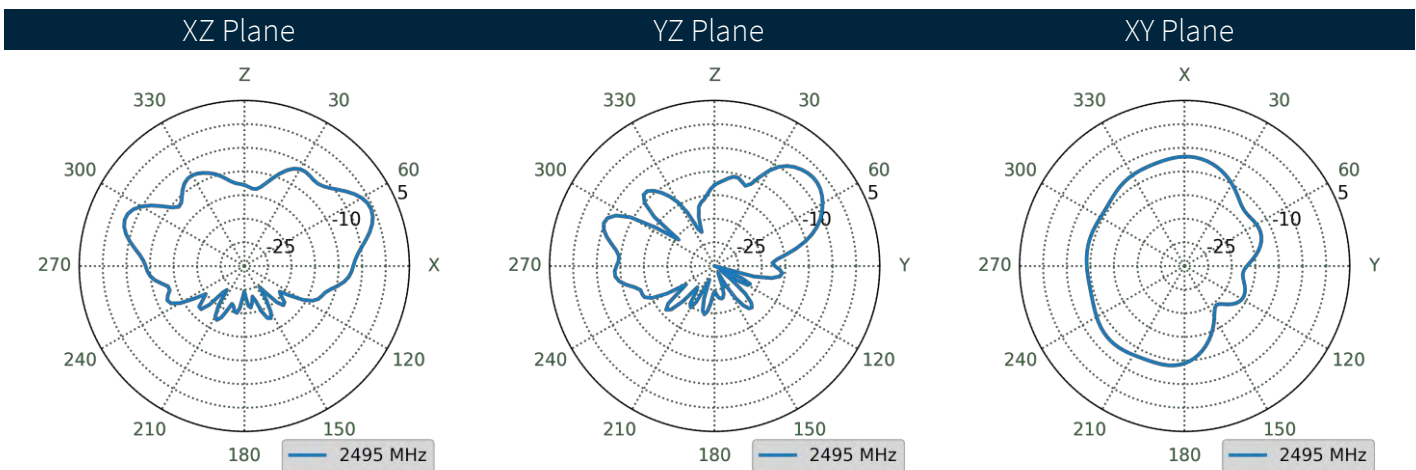
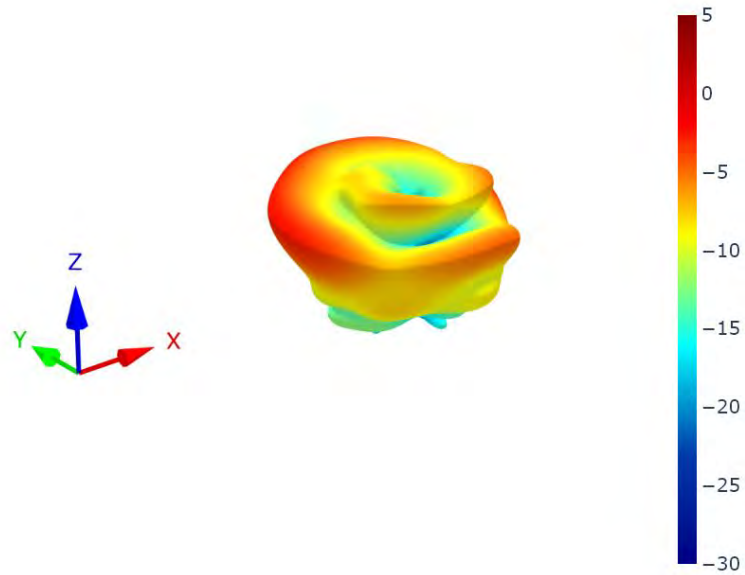

6.31 Cellular2 - Free Space Patterns at 2495 MHz

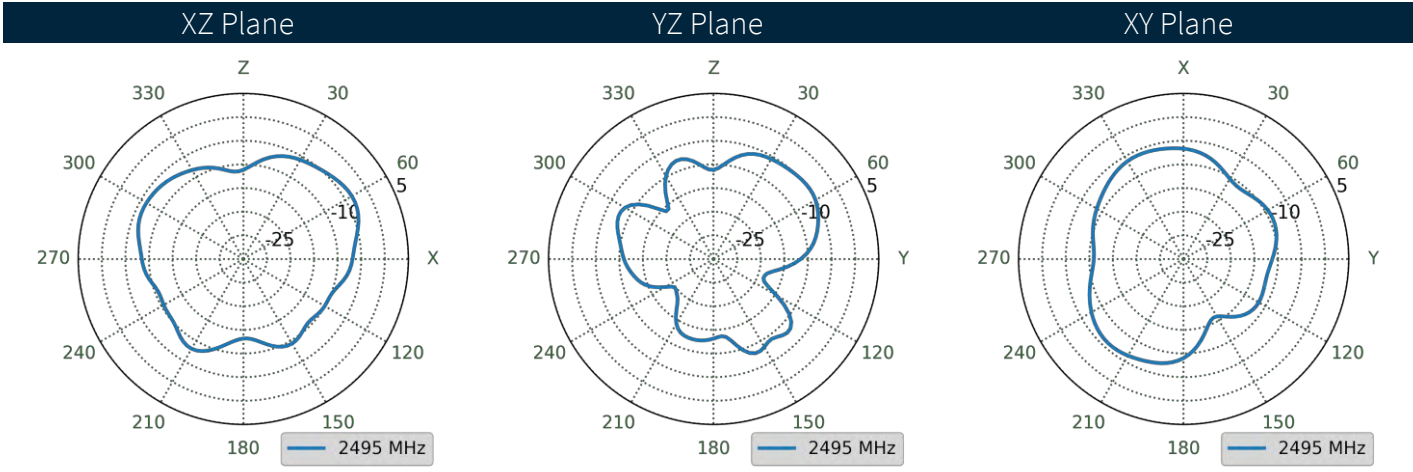
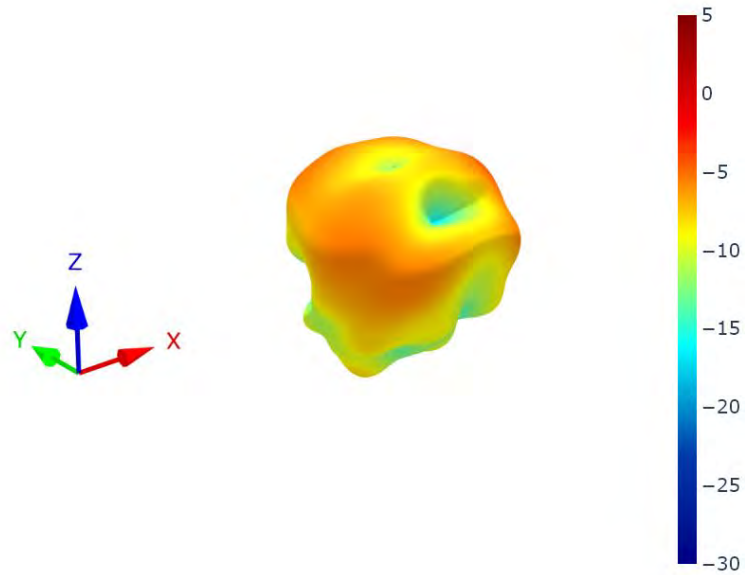



6.32 Cellular1 - 60x60cm Metal Ground Plane Patterns at 4150 MHz

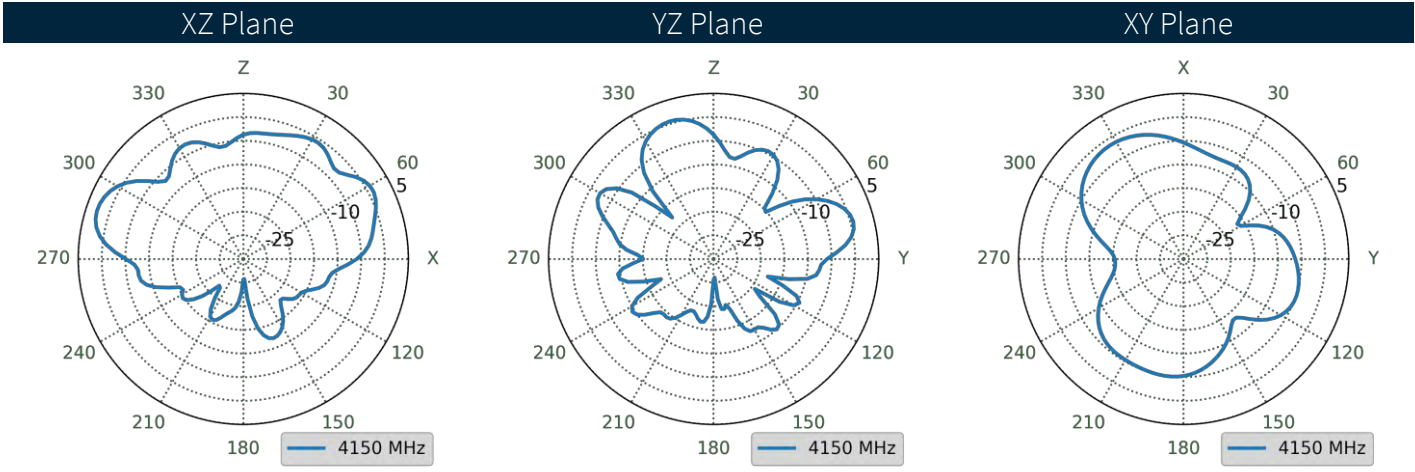
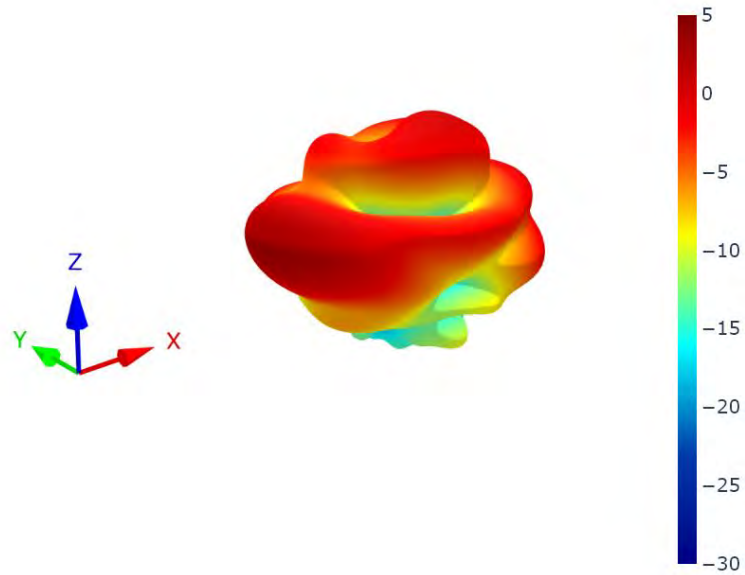

6.33 Cellular1 - Free Space Patterns at 4150 MHz

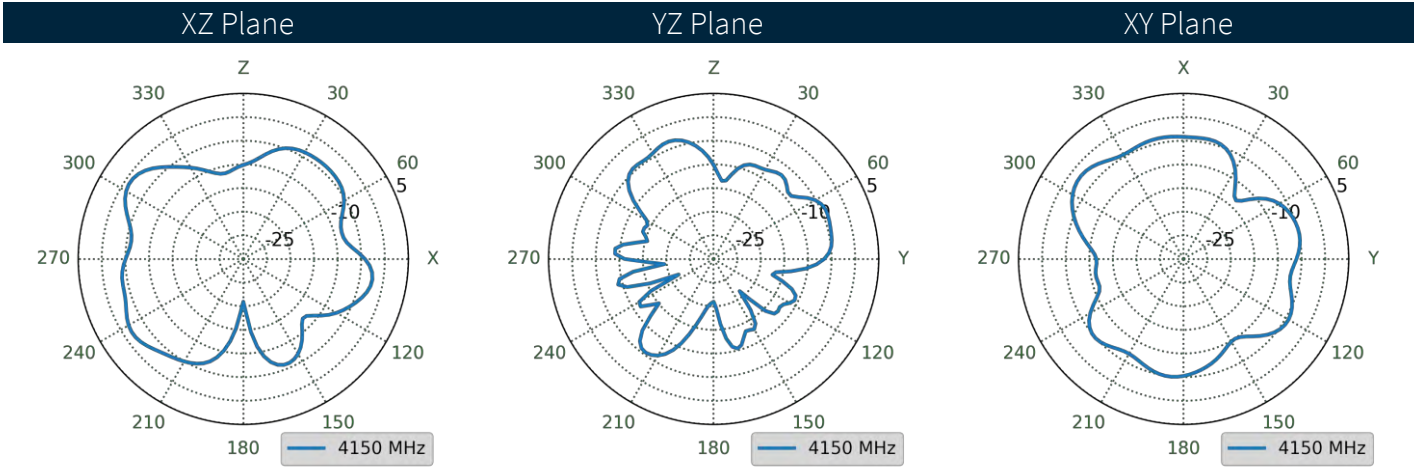
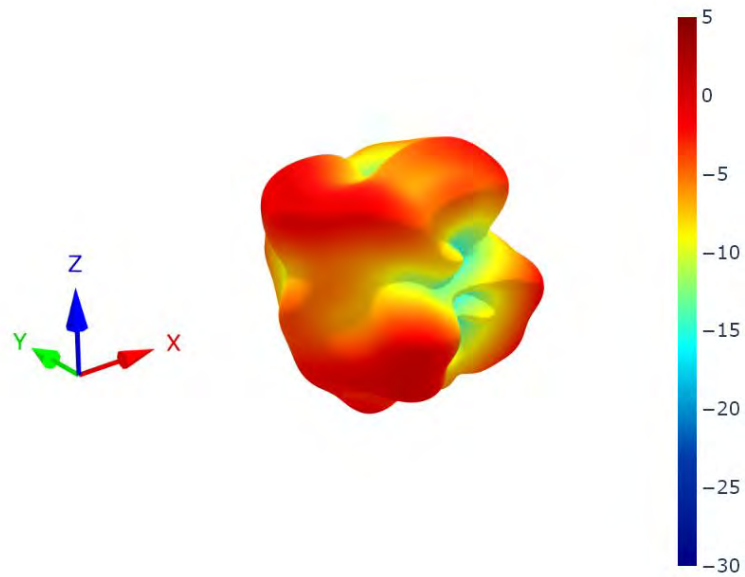

6.34 Cellular2 - 60x60cm Metal Ground Plane Patterns at 4150 MHz

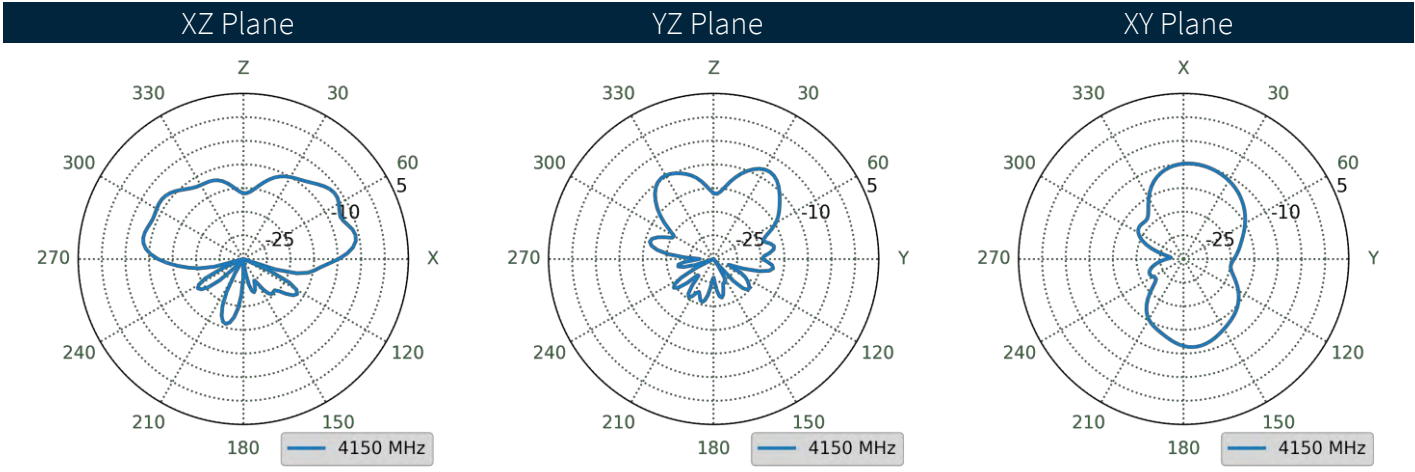
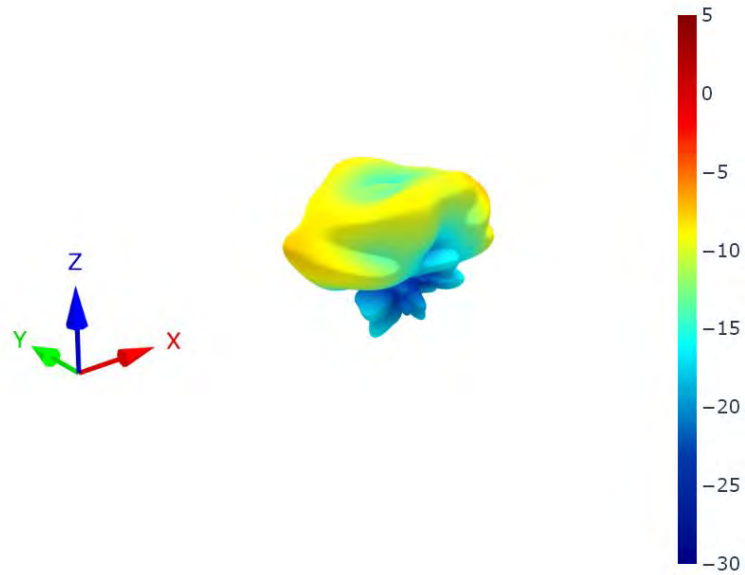

6.35 Cellular2 - Free Space Patterns at 4150 MHz

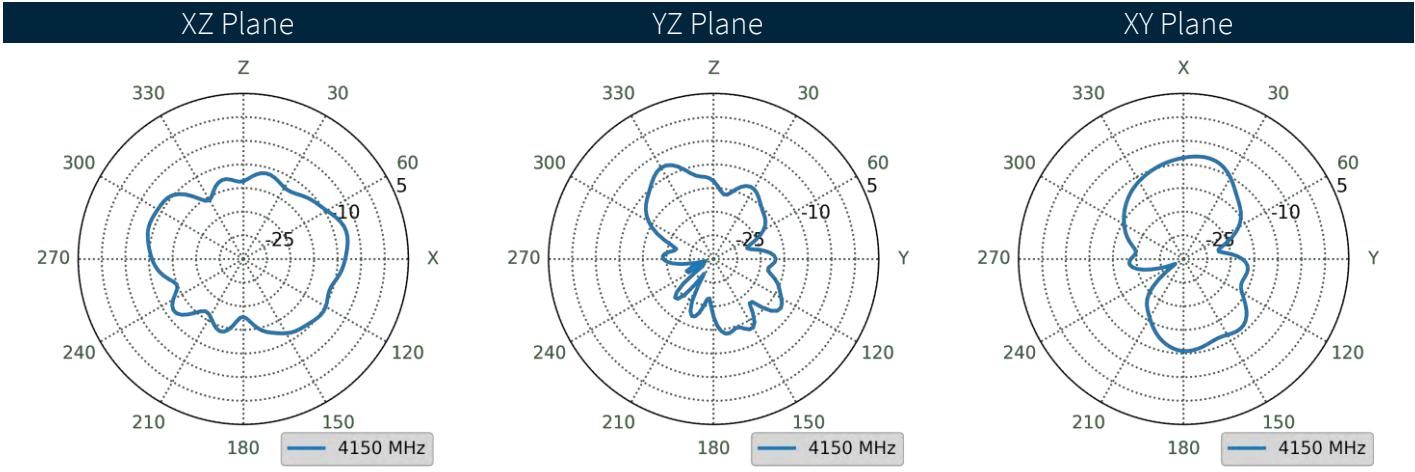
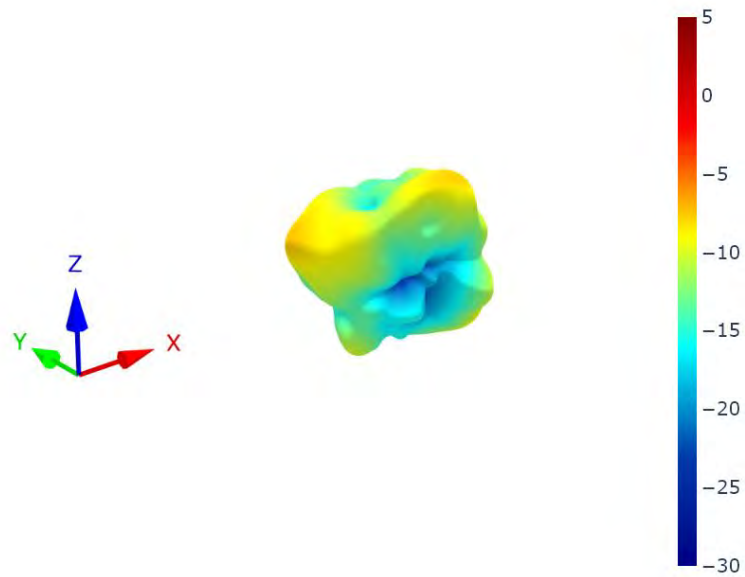

6.36 Cellular1 - 60x60cm Metal Ground Plane Patterns at 5535 MHz

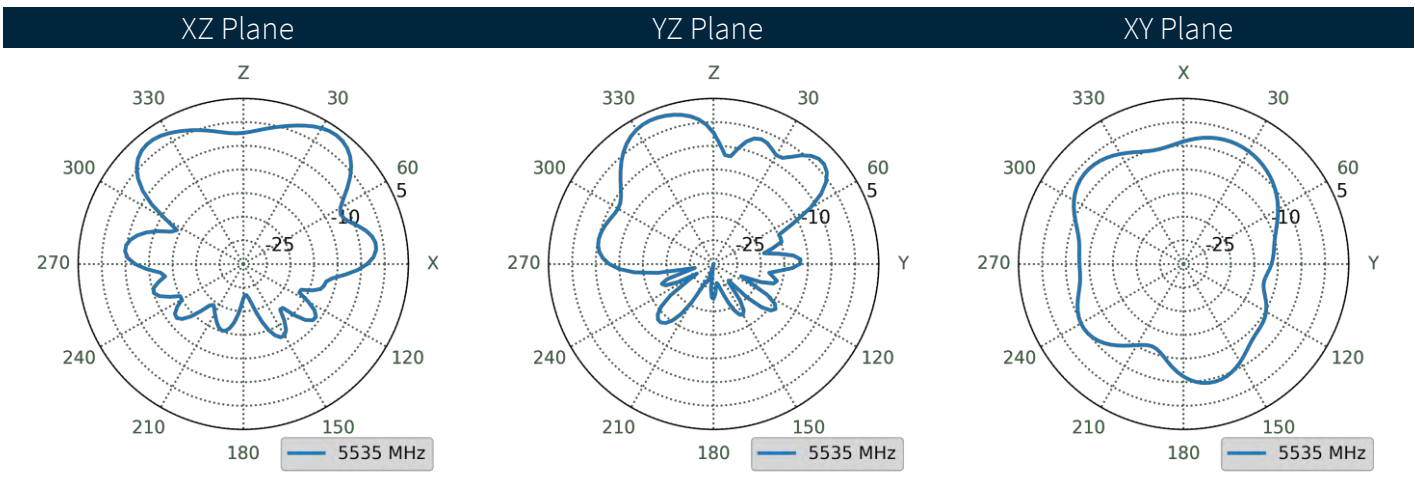
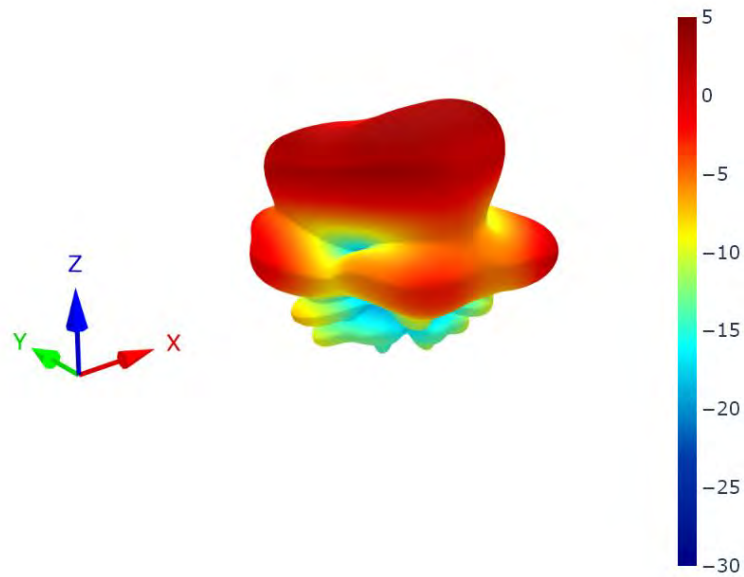

6.37 Cellular1 - Free Space Patterns at 5535 MHz

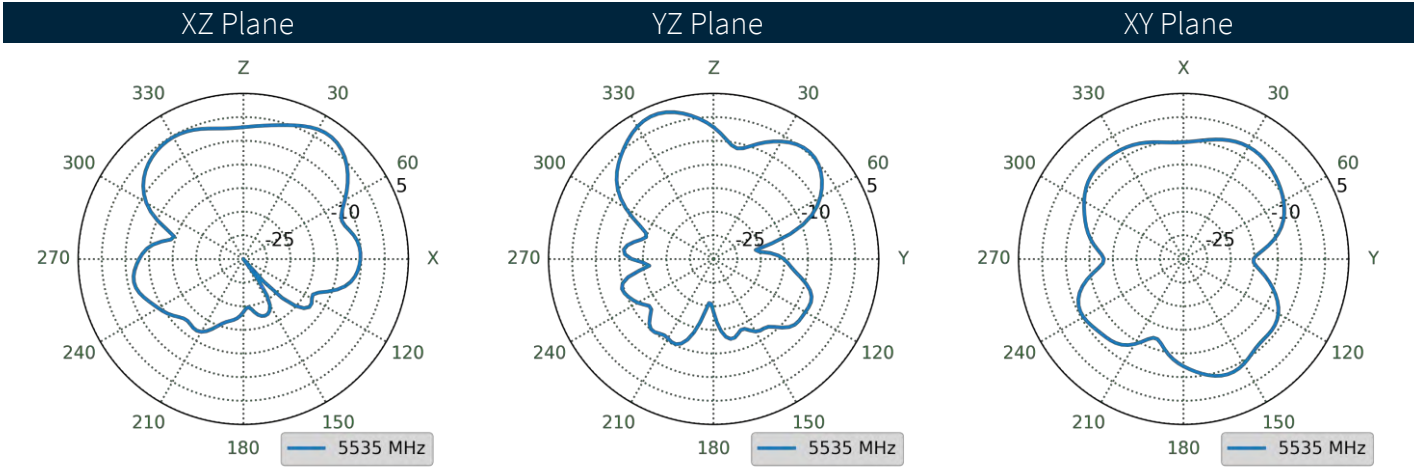
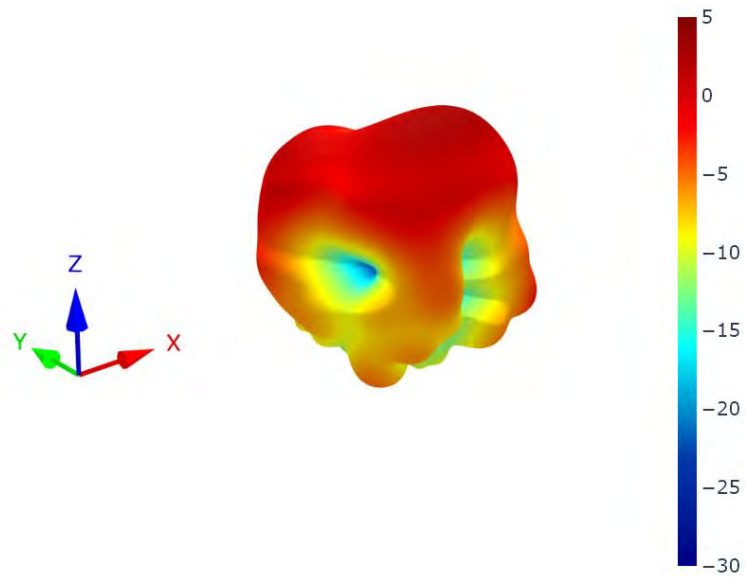

6.38 Cellular2 - 60x60cm Metal Ground Plane Patterns at 5535 MHz

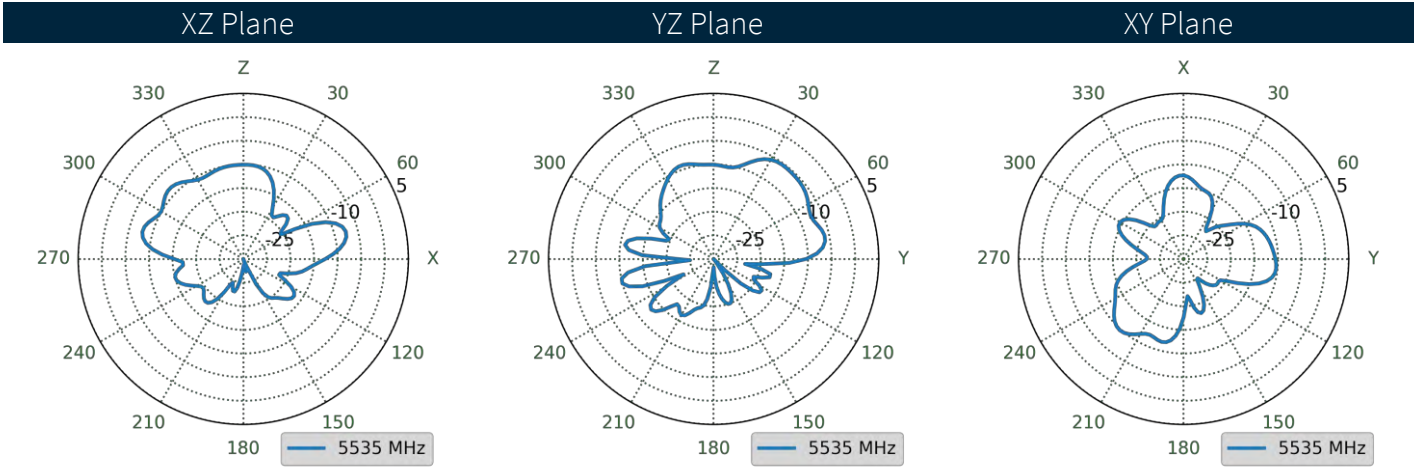
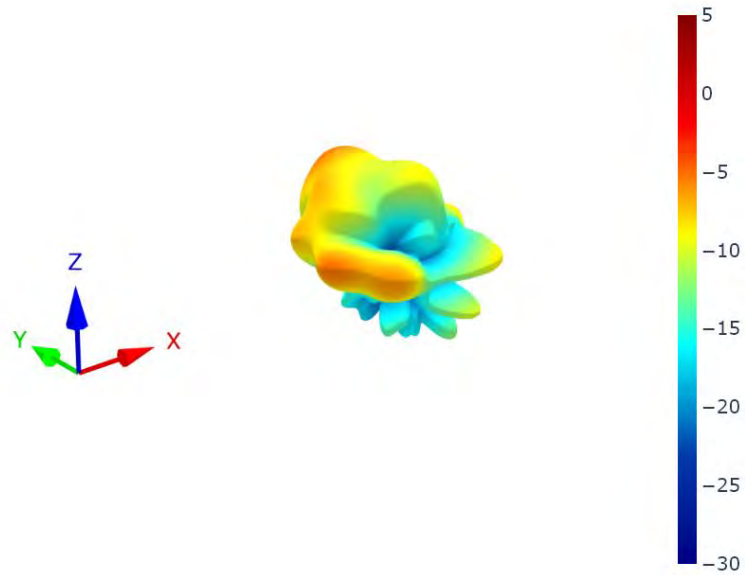

6.39 Cellular2 - Free Space Patterns at 5535 MHz

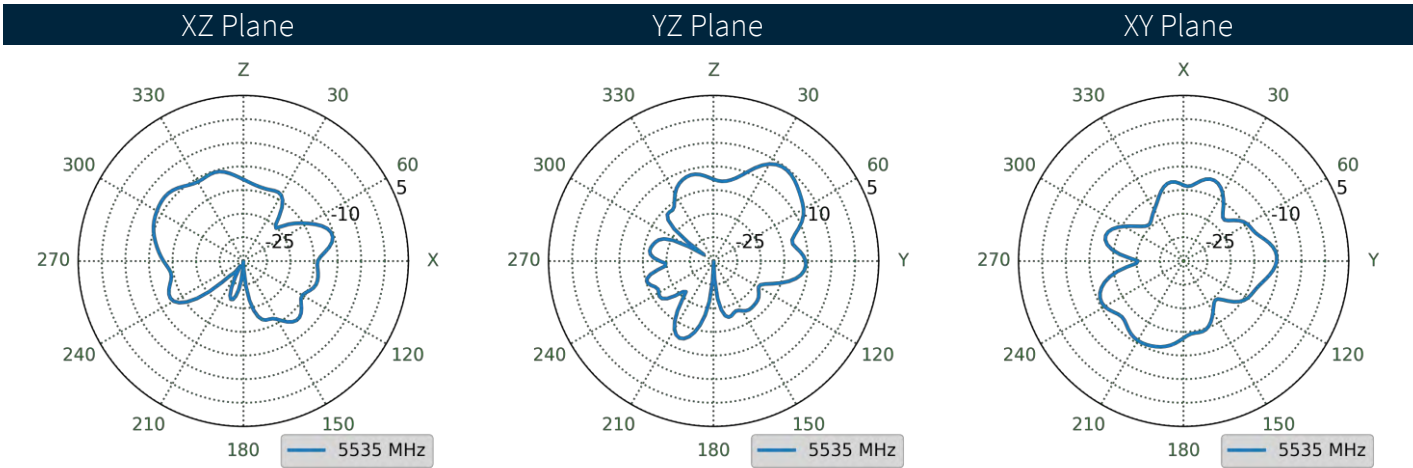
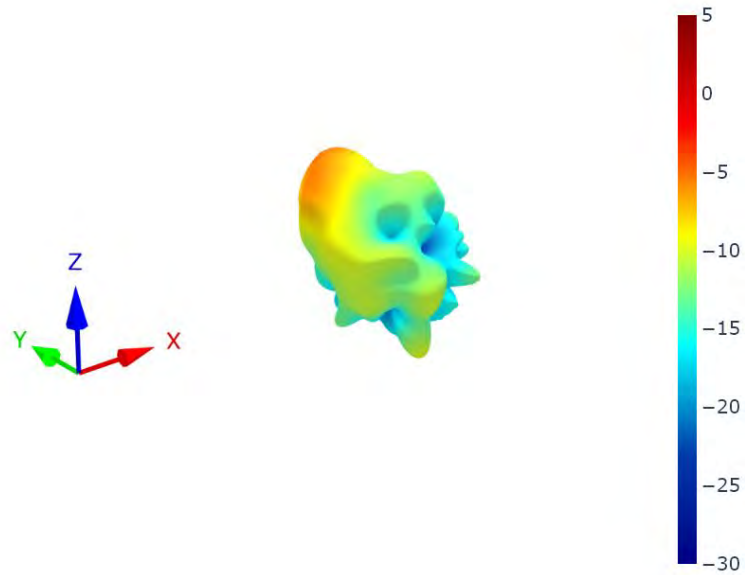



6.40 Wi-Fi1 - 60x60cm Metal Ground Plane Patterns at 2450 MHz

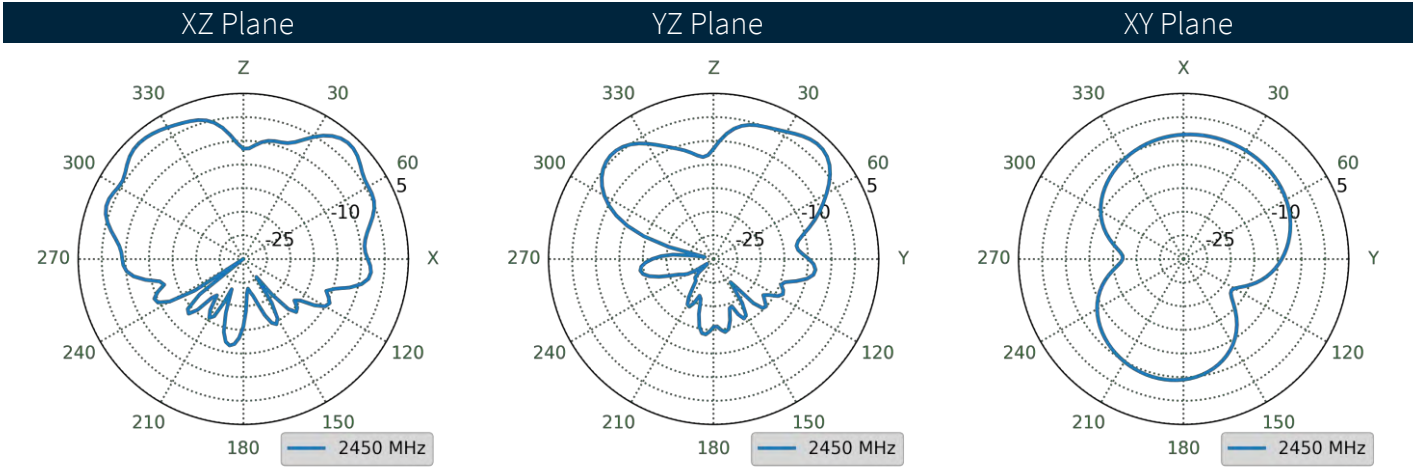
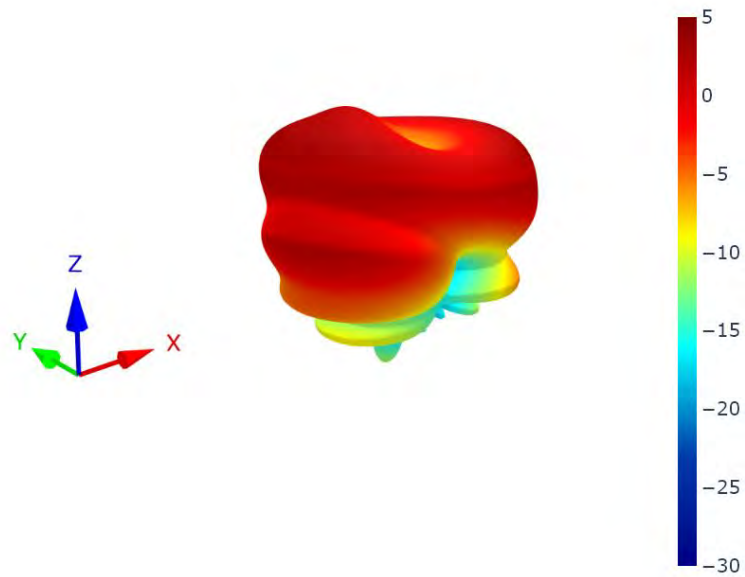

6.41 Wi-Fi1 - Free Space Patterns at 2450 MHz

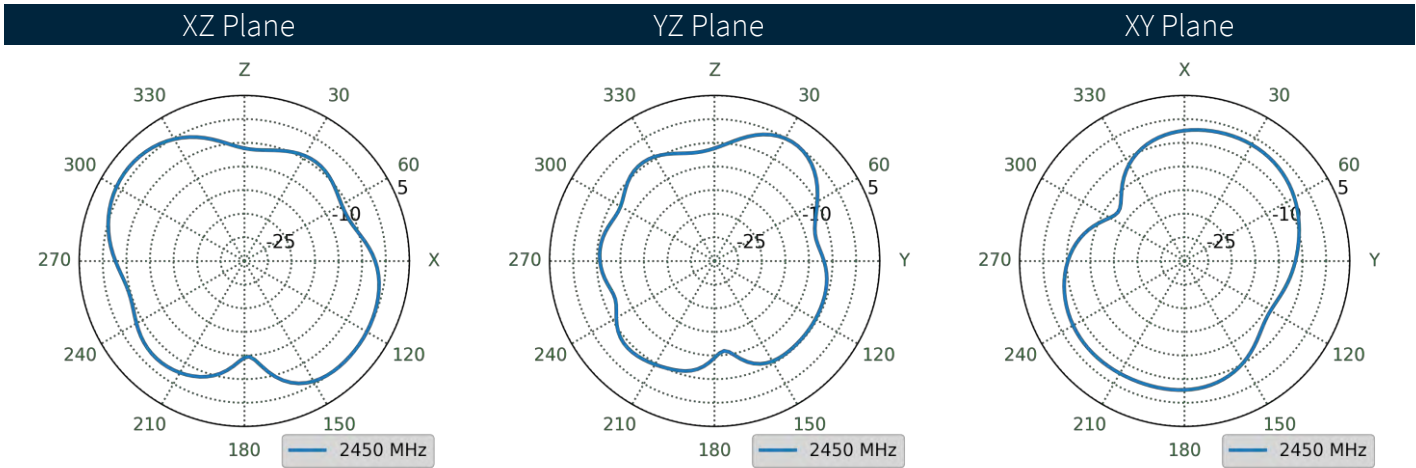
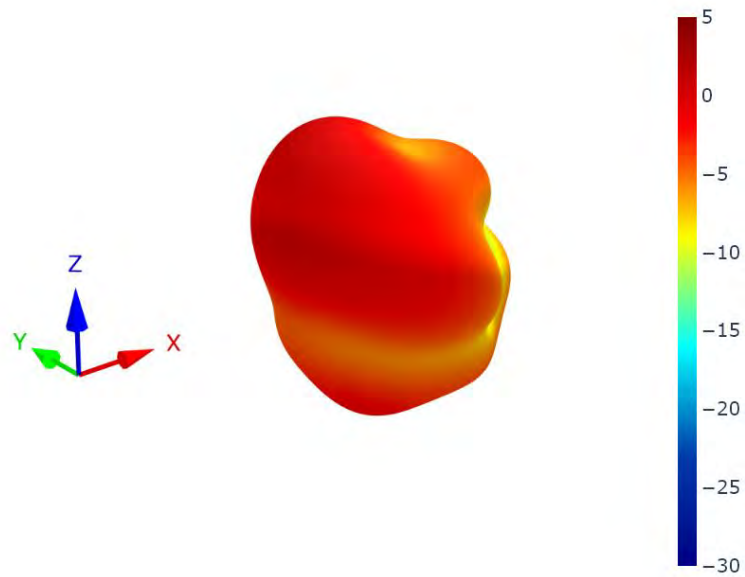

6.42 Wi-Fi2 - 60x60cm Metal Ground Plane Patterns at 2450 MHz

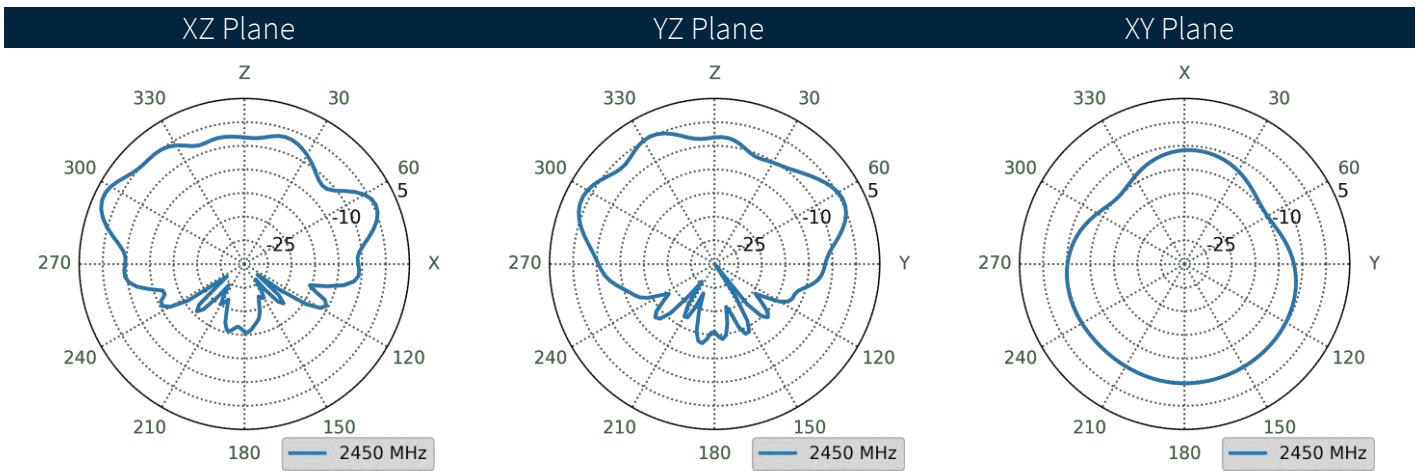
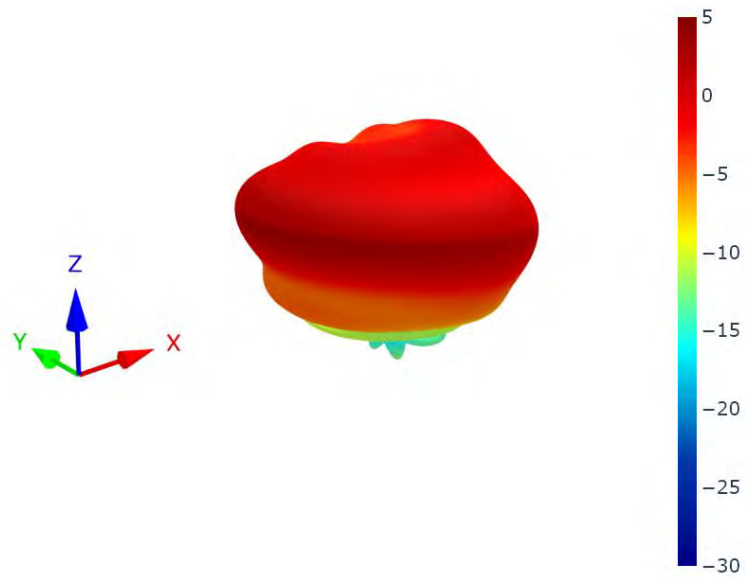

6.43 Wi-Fi2 - Free Space Patterns at 2450 MHz

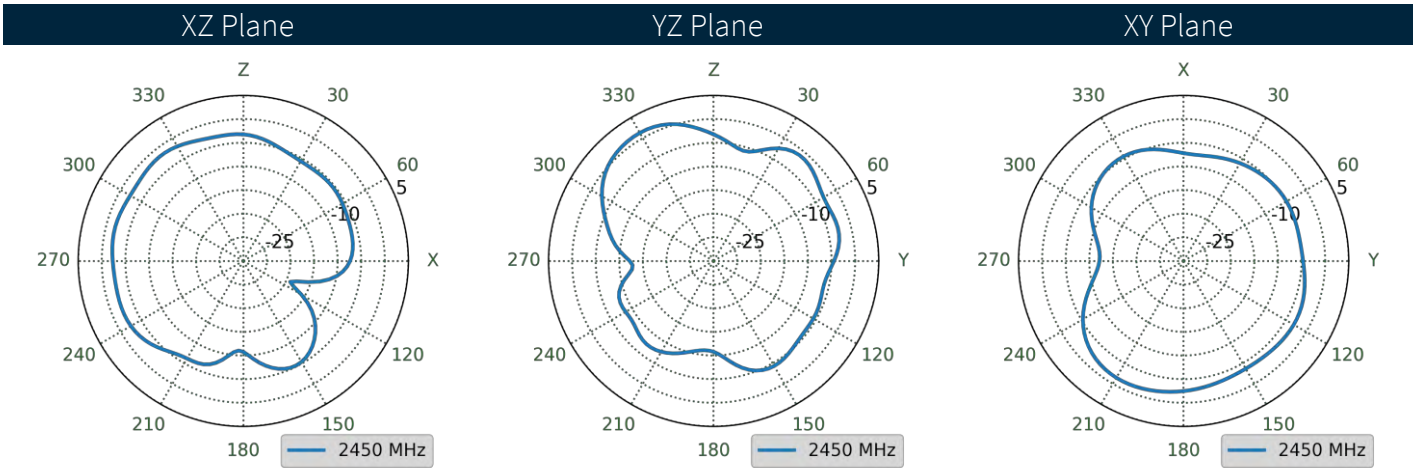
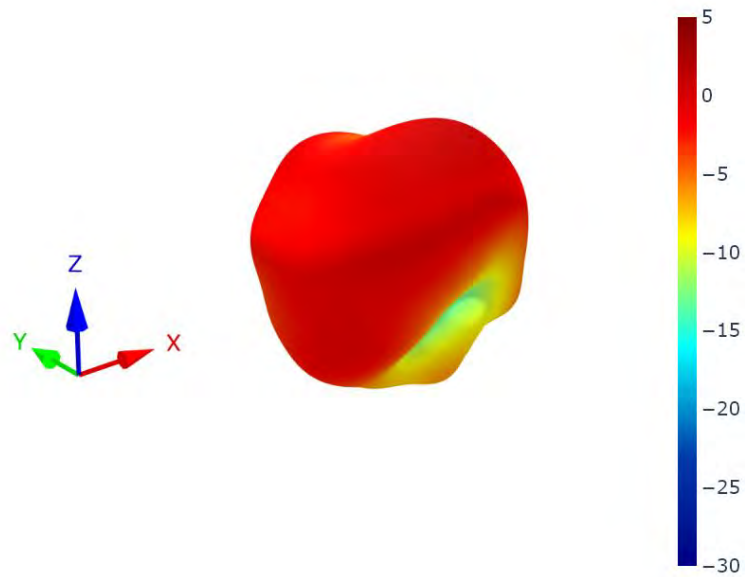

6.44 Wi-Fi1 - 60x60cm Metal Ground Plane Patterns at 5500 MHz

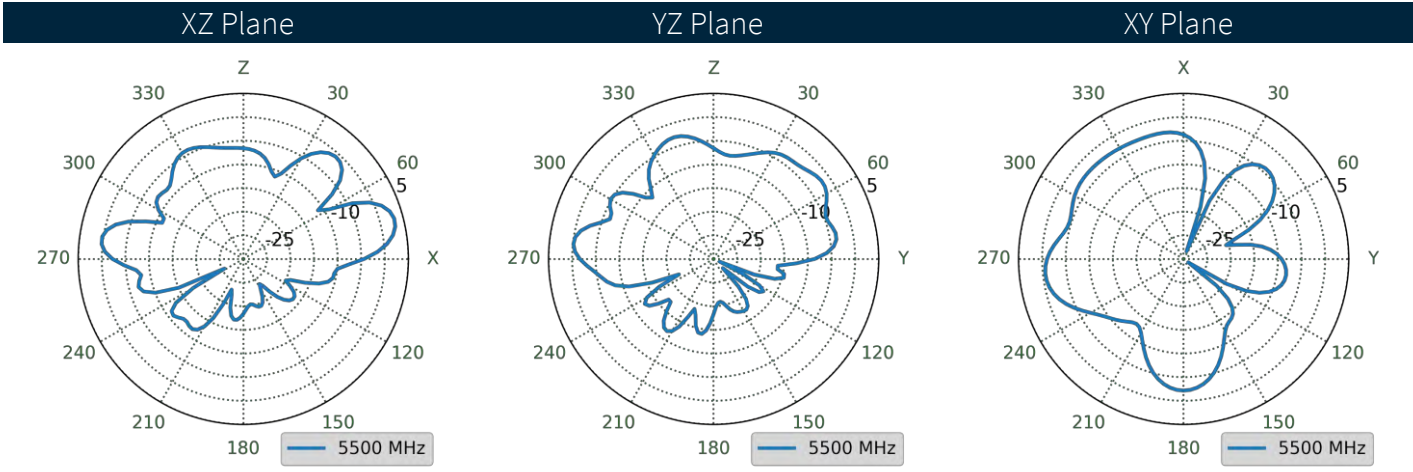
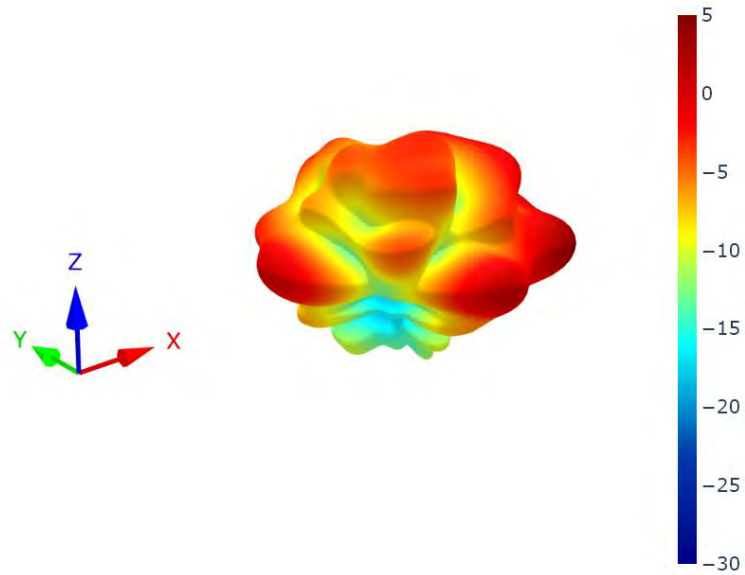

6.45 Wi-Fi1 - Free Space Patterns at 5500 MHz

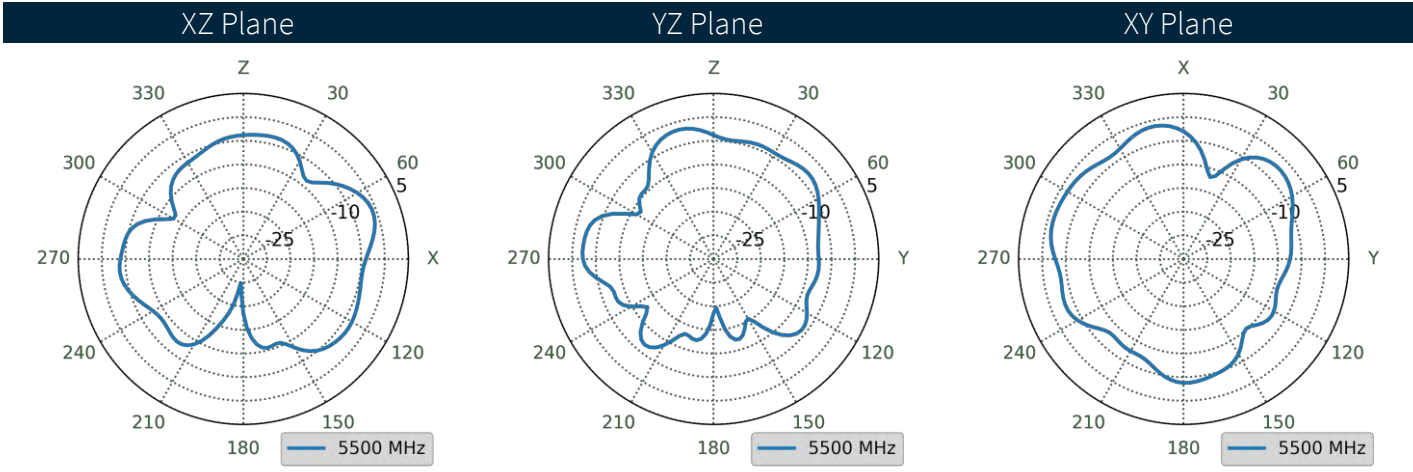
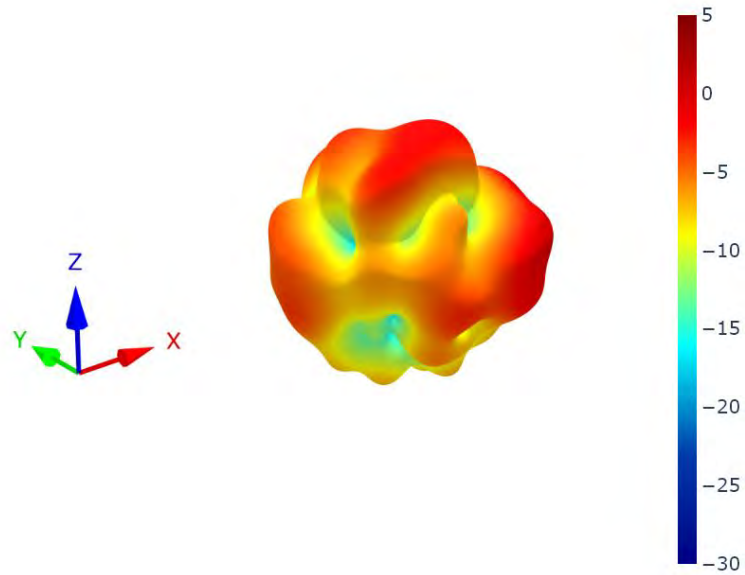

6.46 Wi-Fi2 - 60x60cm Metal Ground Plane Patterns at 5500 MHz

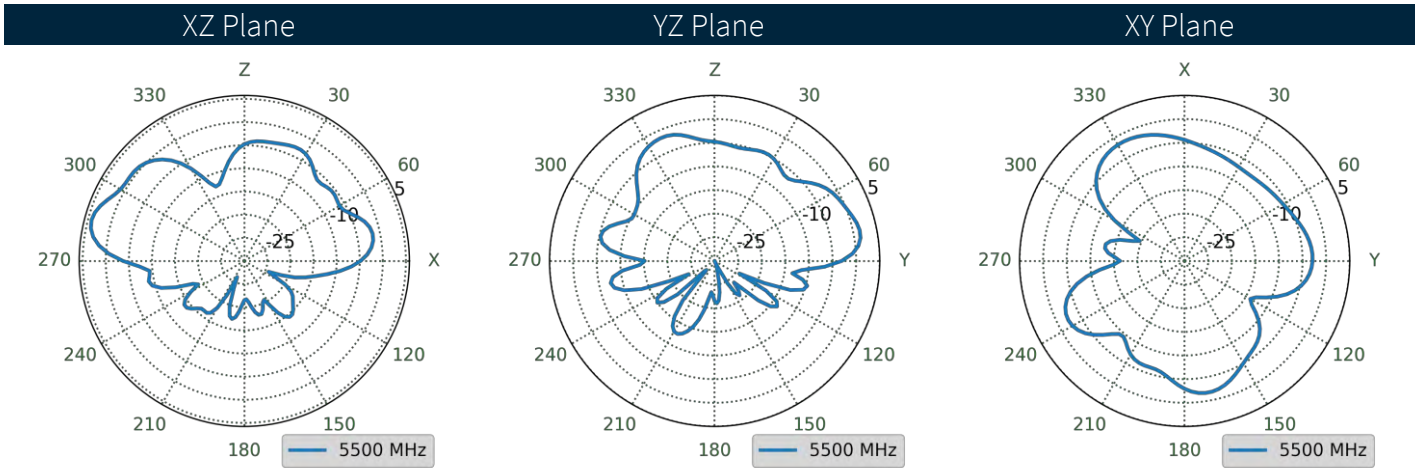
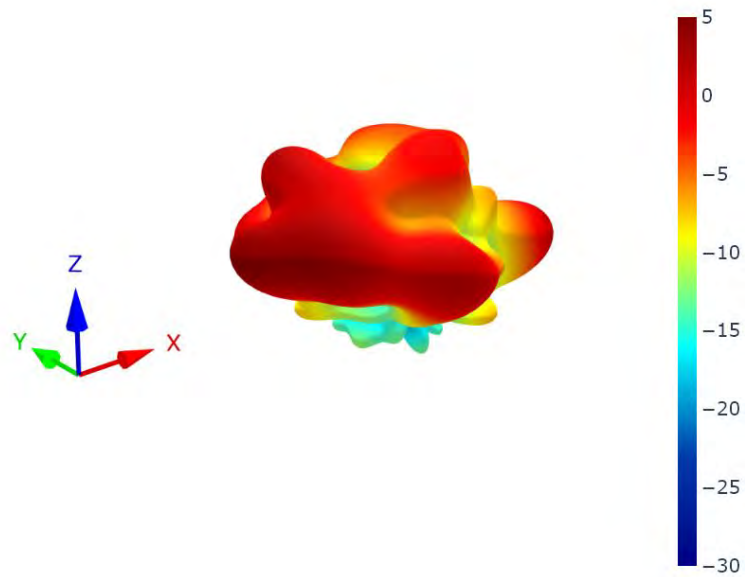

6.47 Wi-Fi2 - Free Space Patterns at 5500 MHz

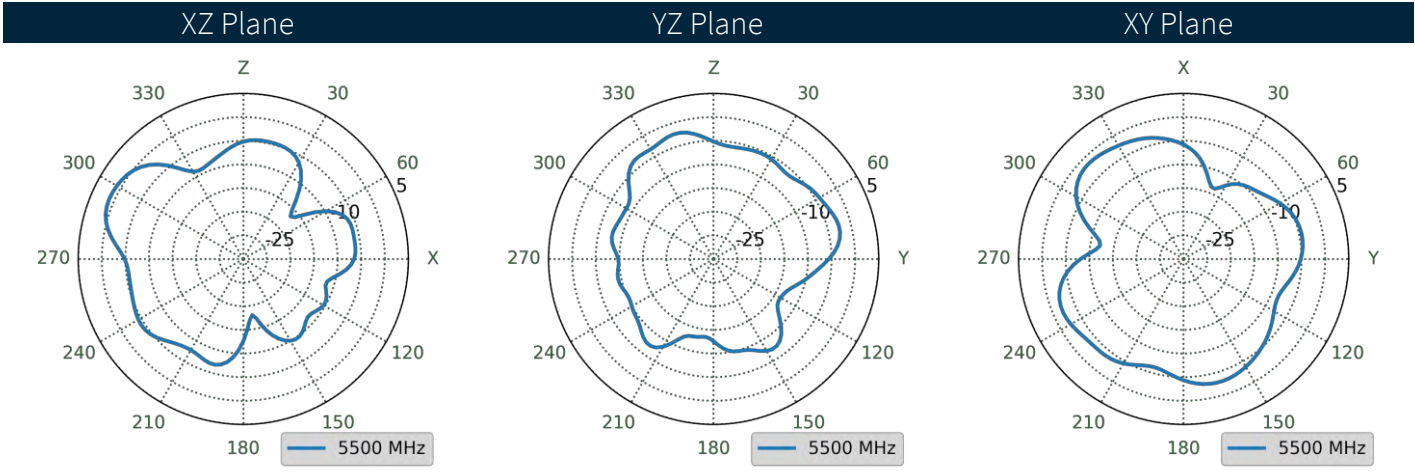
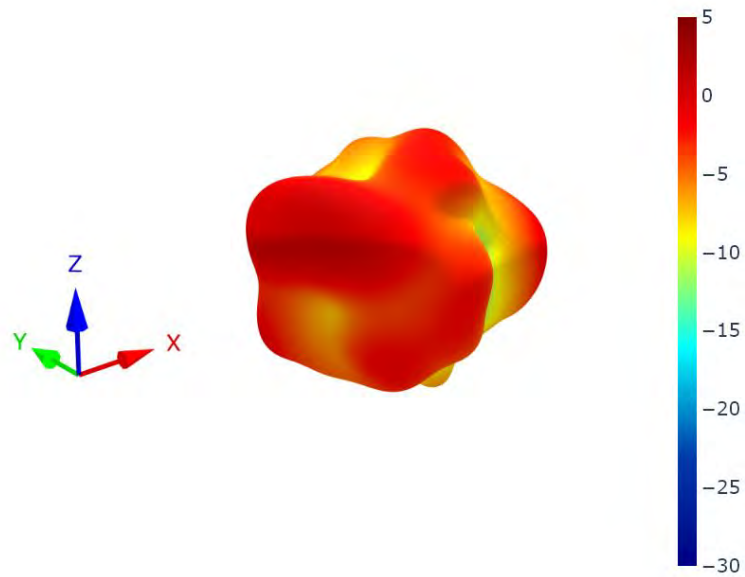



Changelog for the datasheet

**SPE-24-8-285 - MA1047.A.LBICGTT.001**

**Revision: A (Original First Release)**

Date: 2024-12-18

Notes: Initial Release.

Author: Gary West

**Previous Revisions**



[www.taoglas.com](http://www.taoglas.com)



A STELIAU TECHNOLOGY COMPANY

Singel 3 | B-2550 Kontich | Belgium | Tel.+32(0)3 458 30 33  
info@alcom.be | www.alcom.be

Rivium 1e straat 52 | 2909 LE Capelle aan den IJssel | The Netherlands  
Tel.+31(0)10 288 25 00 | info@alcom.nl | www.alcom.nl