

MS6001

Summary Datasheet

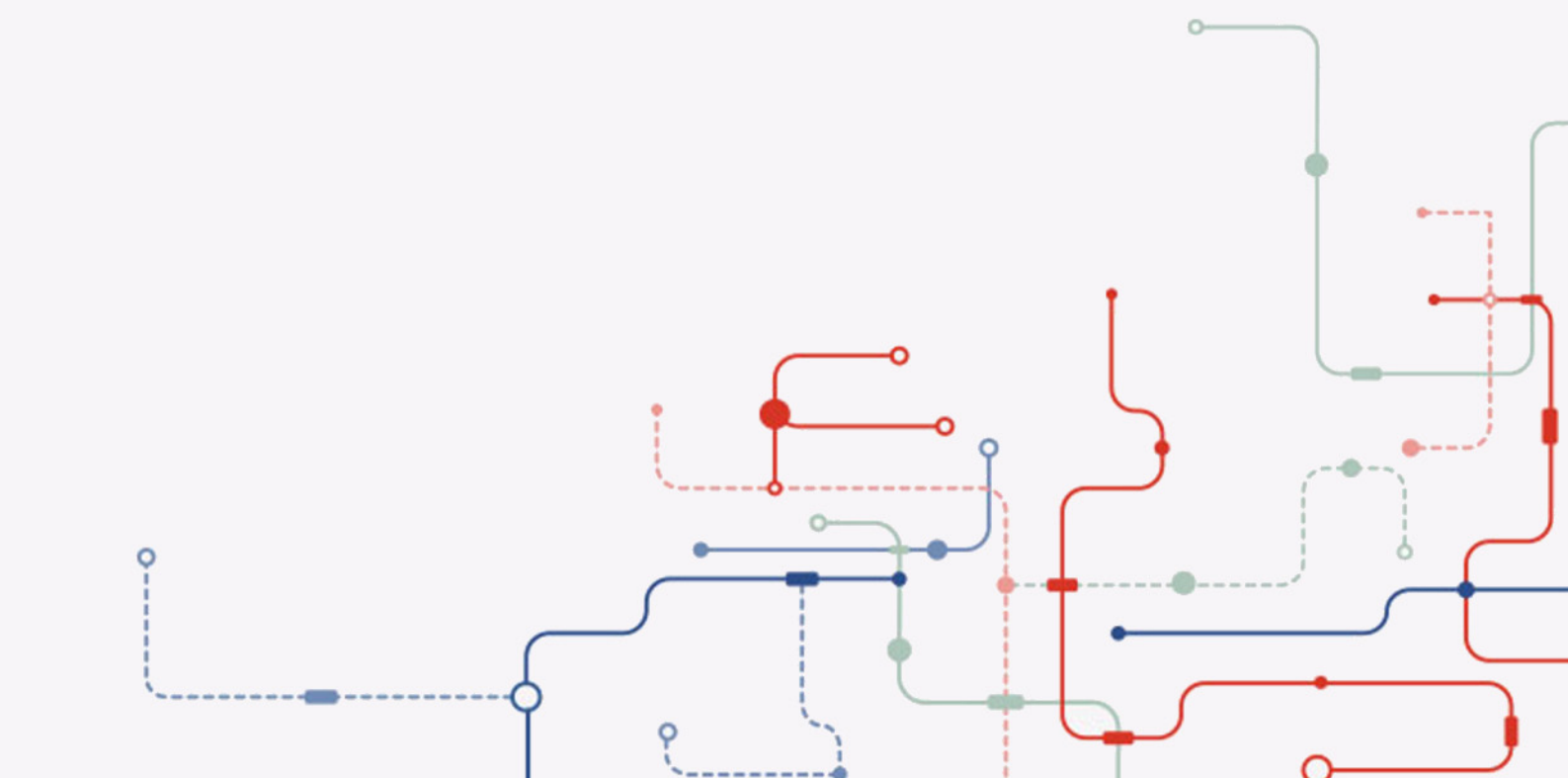

WIS@key

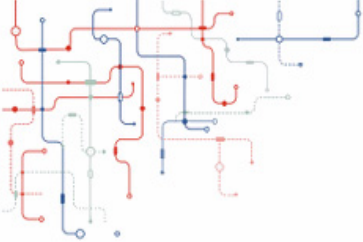

Features

General

- Based on the ARM® SecurCore® SC300™ 32-bit RISC Processor featuring:
 - Harvard architecture
 - Thumb2® High-code-density Instruction Set
 - 3-stage pipeline architecture
 - 8-bit, 16-bit, 32-bit data access
 - Nested Vector Interrupt Controller
 - Memory Protection Unit
- On-chip Programmable System Clock up to 50MHz
- Very Low Power Consumption
 - GSM & ETSI compliant
 - Low power Idle and Power down Modes
- Bond Pad Locations Conforming to ISO7816-2
- ESD Protection : $\pm 4000V$
- Operating range:
 - From 1.62V to 5.5V
 - From - 40°C to 105°C
- Compliant with GSM, 3GPP, EMVCo Specifications

Memory

- 1MBytes of FLASH Memory:
 - Pages of 128 bytes
 - 2 Kbytes of OTP
 - 500,000 Write/Erase Cycles at 25°C using Wear-Leveling
 - 10 Years Data Retention
 - Flash write & erase low power modes
- 64 Kbytes of ROM for Crypto Library, Wear-Leveling and Secure Bootloader code
- 24 Kbytes of RAM Memory (20 Kbytes of ARM CPU Core RAM, 4 Kbytes of Ad-X™3 RAM, shared with the ARM CPU Core)

Peripherals

- One ISO 7816 Controller
 - Up to 625 Kbps at 5MHz
 - Compliant with T=0 and T=1 Protocols
- SWP Slave interface: Single Wire Protocol controller for communications with NFC chip
- High Speed SPI Interface up to 20Mbits/s
- I²C Interface up to 1Mbits/s
- 5 GPIOs (including IO0 and IO1)
- Three 16-bit Timers
- SysTick 24-bit timer, part of the SC300
- Interfaces and Class detectors
- Random Number Generator (RNG)
- Hardware DES/TDES DPA /DEMA Resistant
- Hardware AES
- CRC 16 & 32 Engine (Compliant with ISO/IEC 3309)
- 32-bit Cryptographic Accelerator (Ad-X3 for Public Key Operations)
 - RSA, DSA, ECC, ECDH
- High performance Hardware Java Card Accelerator

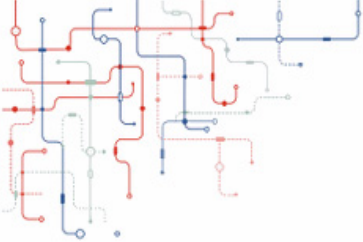

Security

- Dedicated Hardware for Protection Against SPA/DPA/SEMA/DEMA Attacks
- Advanced Protection Against Physical Attack, Including Active Shield, Enhanced Protection Object, Stack Checker, Slope Detector, Parity Errors
- Environmental Protection Systems
- Voltage Monitor
- Frequency Monitor
- Temperature Monitor
- Light Protection
- Secure Memory Management/Access Protection
- Memory Protection Unit, part of the SC300

Description

The MS6001 architecture is based on the ARM® SecurCore® SC300 which offer high performance and very low power consumption. The core features a Thumb-2 instruction set, low interrupt latency, hardware divide, interruptible/continuable multiple load and store instructions, automatic state save and restore for interrupts, tightly integrated interrupt controller and multiple core buses capable of simultaneous accesses. Pipeline techniques are employed ensuring that all parts of the processing and memory systems can operate continuously.

The SC300 instruction set provides the exceptional performance expected of a modern 32-bit architecture, with the high code density of 8-bit and 16-bit microcontrollers. The processor closely integrates a configurable nested vectored interrupt controller (NVIC), to deliver industry leading interrupt performance. To offer efficient low-power modes, the NVIC features a deep sleep function that enables the entire device to be rapidly powered down.

The MS6001 features a ROM memory dedicated to the storage of low level drivers, bootloader, Wear Leveling and cryptographic code. A large flash memory mapped in both data and code space provide a flexible way to store user data and program code.

The Ad-X3 hardware cryptographic accelerator featured in the MS6001 is dedicated to perform fast encryption or authentication functions.

Thanks to the built-in MPU of the SC300, the MS6001 can enforce privilege rules, separate processes, enforce access rules over the entire 4GB addressing space.

Additional security features include fault injection resistance, hardware shield, scrambling of program, data and addresses, power analysis countermeasures and memory accesses controller by privileged modes.

Thanks to its dedicated set of peripherals, the MS6001 is an ideal product for application such as a Secure Element, compliant to ETSI standards. Moreover, through its specific choice of communication interfaces, the MS6001 is able to provide a tailored solution to applications in embedded systems.

Development Tools

- IAR Embedded Workbench® EWARM ⁽¹⁾
- Software Libraries and Application Notes

Certification Targeted

- EMVCo
- AIS-31
- CC EAL5+
- FIPS 140-3

1. Licence not included - contact IAR

Figure 1 MS6001 ARM CPU Core Architecture

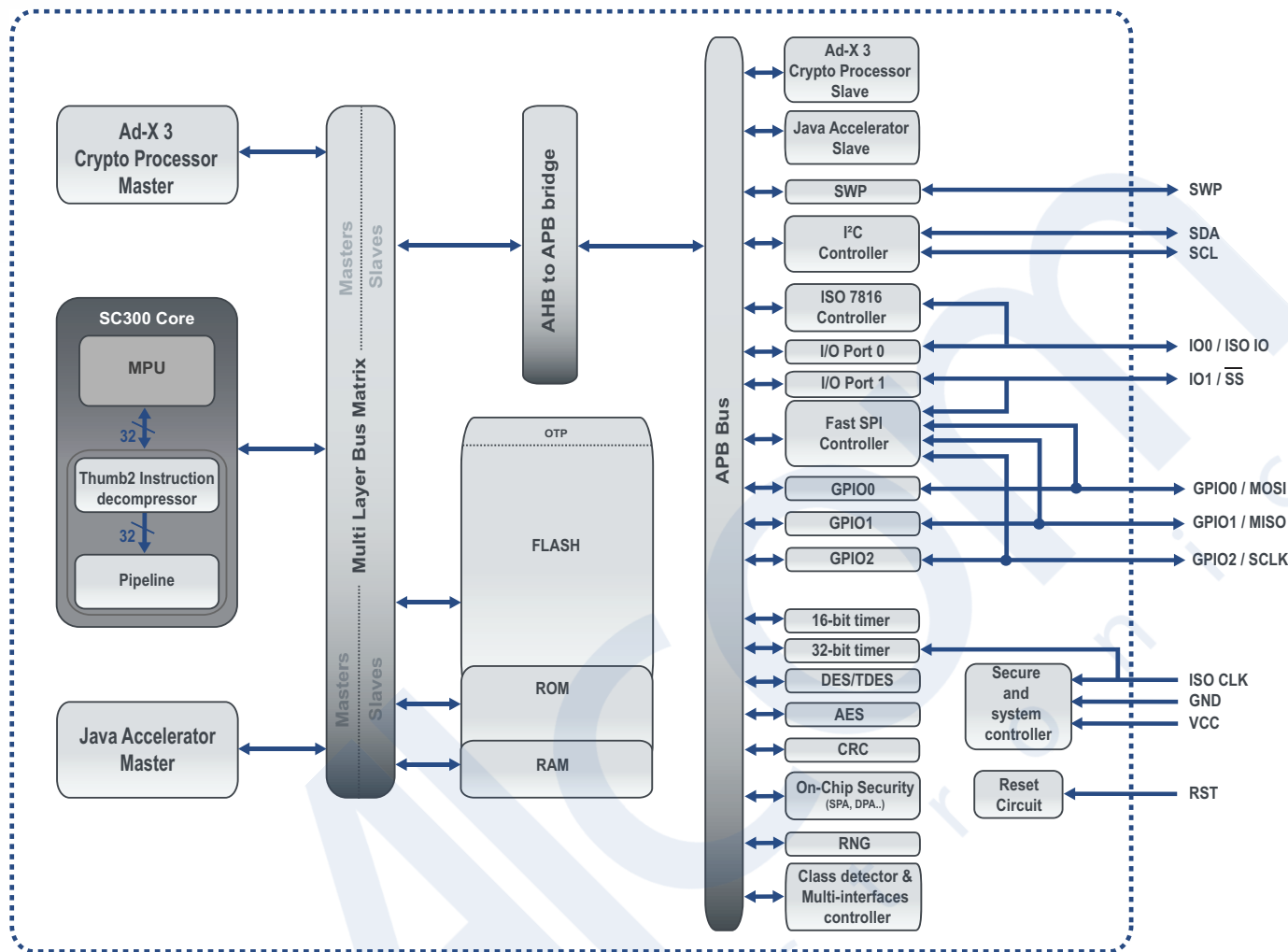



AC/DC Characteristics

Maximum Ratings

| Parameter | Symbol | Min. | Max. | Unit |
|-----------------------|----------|------|------|------|
| Supply Voltage | V_{CC} | -0.3 | 7 | V |
| Operating Temperature | T_A | -40 | +105 | °C |

AC/DC Characteristics (1.62V - 5.50V range; T= -40°C to +105°C)

| Symbol | Parameter | Conditions | Min. | Typ. | Max. | Units |
|------------------|--|--|---|--|-----------------------|-----------|
| V_{CC} | Supply Voltage | | 1.62 | | 5.5 | V |
| F_{VFO} | Processor Clock Input Frequency | with $V_{CC}=4.5V$ config 20MHz config 50MHz | 18 46 | 20 50 | 24 61 | MHz |
| $F_{peripheral}$ | Peripheral Clock Frequency | with $V_{CC}=4.5V$ | 18 | 22 | 24 | MHz |
| V_{MAX} | Voltage Monitor: High Level Detection | | 6.1 | 6.3 | 6.4 | V |
| V_{MIN} | Voltage Monitor: Low Level Detection | | 1.1 | 1.2 | 1.6 | V |
| T_{MAX} | Temperature monitor High Level Detection | | | 110 | | °C |
| T_{MIN} | Temperature monitor Low Level Detection | | | -40 | | °C |
| V_{POR} | Power-on Reset Voltage | | 1 | 1 | 1.45 | V |
| t_{POR} | Power-on Reset Period | $V_{CC}=5V$ V_{CC} rise time=10 μ s LowPowerStartup=0 LowPowerStartup=1 | | 112 226 | | μ s |
| t_{TOUT} | Reset Delay Time-out Period | warm reset ISO400 fuse = 0 | | 523 | | t_{CYC} |
| | | warm reset ISO400 fuse = 1 | the longest of 523 t_{CYC} or 7 t_{CYC} + 403 t_{isoclk} | | | |
| | | POR (cold reset) LowPowerStartup=0 LowPowerStartup=1 | | 980 2549 | | t_{CYC} |
| t_{FLASHW} | FLASH Write Time | per word | 50 | 55 | 60 | μ s |
| t_{FLASHE} | FLASH Erase Time | per 2Kbytes sector | 2 | 2+0.5 | 10 | ms |
| t_{CYC} | CPU Cycle Time | LowPowerStartup=0 LowPowerStartup=1 | | 4.10 ⁹ / F_{VFO} 10 ⁹ / F_{VFO} | | ns |
| RST I_{IL} | Leakage Current RST | $V_{IN}=0V$ | | 0 | | μ A |
| RST I_{IH} | Leakage Current RST | $V_{IN}=V_{CC}$ | | 0 | | μ A |
| RST V_{IH} | Input High Voltage, RST signal | | 0.7xV _{CC} | NA | V _{CC} +0.3 | V |
| RST V_{IL} | Input Low Voltage, RST signal | | -0.3 | NA | 0.2 x V _{CC} | V |
| CLK I_{IL} | Leakage Current CLK | $V_{IN} = 0$ | | 0 | | μ A |
| CLK I_{IH} | Leakage Current CLK | $V_{IN} = V_{CC}$ | | 0 | | μ A |
| CLK V_{IH} | Input High Voltage, CLK signal | | 0.7xV _{CC} | NA | V _{CC} +0.3 | V |

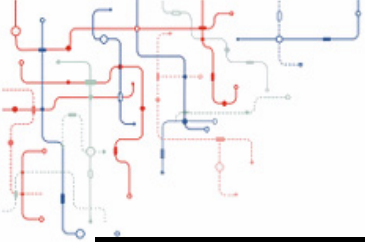

| Symbol | Parameter | Conditions | Min. | Typ. | Max. | Units |
|----------------------------|---|--|---------------------|-----------------------------|----------------------|-----------|
| CLK V_{IL} | Input Low Voltage, CLK signal | | -0.3 | NA | $0.2 \times V_{CC}$ | V |
| I/O I_{IL} | Leakage Current I/O | $V_{IN}=0$ | | 0 | | μA |
| I/O I_{IH} | Leakage Current I/O | $V_{IN}=V_{CC}$ | | 0 | | μA |
| I/O V_{IH} | Input High Voltage, I/O signal | | $0.7 \times V_{CC}$ | NA | $V_{CC}+0.3$ | V |
| I/O V_{IL} | Input Low Voltage, I/O signal | | -0.3 | NA | $0.2 \times V_{CC}$ | V |
| I/O V_{OH} | Output High Voltage, I/O signal | $I_{OH}=20\mu A$ $R_{PULLUP}=20K$ | $0.7 \times V_{CC}$ | | | V |
| I/O V_{OL} | Output Low Voltage, I/O signal | $I_{OL}<1mA$, ClassA | | | $0.08 \times V_{CC}$ | V |
| I/O V_{OL} | Output Low Voltage, I/O signal | $I_{OL}<0.5mA$, ClassB | | | $0.15 \times V_{CC}$ | V |
| I/O V_{OL} | Output Low Voltage, I/O signal | $I_{OL}<0.5mA$, ClassC | | | $0.15 \times V_{CC}$ | V |
| T_r | I/O Output Rise Time | $C_{out} = 30 \text{ pF}$, $R_{PULLUP} = 220K$ | 9.2 | 12.1 | 18.3 | ns |
| T_f | I/O Output Fall Time | $C_{out} = 30 \text{ pF}$ | 10.1 | 13.0 | 20.1 | ns |
| $R_{I/O \text{ PULLUP}}$ | RST Pin Pullup IO0, IO1, GPIO0 to 2 Pin Pullup SCK Pin Pullup SWP Pin Pullup | | | 220 220 220 900 | | $k\Omega$ |
| $R_{I/O \text{ PULLDOWN}}$ | RST Pin Pulldown IO0, IO1, GPIO0 to 2 Pin Pulldown SCK Pin Pulldown SWP pad Pulldown | | | 1000 1000 1000 900 | | $k\Omega$ |

Note: 1. In deep sleep Mode, the external clock can be stopped. The Frequency and temperature Monitors are switched off



Typical power consumption.

| Symbol | Parameter | Conditions | Min. | Typ. | Max. | Units |
|-------------|------------------------------|---|------|----------------------|------|---------|
| I_{PDN-T} | IDD total in Power down mode | config 20MHz 4.5V < VCC < 5.50V 2.7V < VCC < 4.5V 1.62V < VCC < 2.7V | | 97 86 80 | | μA |
| | | config 50MHz 4.5V < VCC < 5.50V 2.7V < VCC < 4.5V 1.62V < VCC < 2.7V | | 121 105 98 | | |
| I_{RUN} | IDD when CPU runs | config 20MHz 4.5V < VCC < 5.50V 2.7V < VCC < 4.5V 1.62V < VCC < 2.7V | | 5.1 4.6 4.4 | | mA |
| | | config 50MHz 4.5V < VCC < 5.50V 2.7V < VCC < 4.5V 1.62V < VCC < 2.7V | | 8.6 7.9 7.6 | | |
| I_{Ad-X3} | IDD when Ad-X3 runs | config 20MHz 4.5V < VCC < 5.50V 2.7V < VCC < 4.5V 1.62V < VCC < 2.7V | | 6.3 5.9 5.7 | | mA |
| | | config 50MHz 4.5V < VCC < 5.50V 2.7V < VCC < 4.5V 1.62V < VCC < 2.7V | | 12 11.3 11.0 | | |
| I_{Worst} | IDD when all features run | config 20MHz 4.5V < VCC < 5.50V 2.7V < VCC < 4.5V 1.62V < VCC < 2.7V | | 8.8 8.3 8.1 | | mA |
| | | config 50MHz 4.5V < VCC < 5.50V 2.7V < VCC < 4.5V 1.62V < VCC < 2.7V | | 17.9 17.2 16.8 | | |



Pin and Packages Configurations

Module

| | |
|---|--|
| GND | Ground (reference voltage) |
| VCC | Power supply input |
| ISO IO | Input or Output for serial data (ISO 7816) |
| ISO CLK | ISO CLK ISO 7816 input clock |
| ISO $\overline{\text{RST}}$ | ISO Reset signal input |
| SWP | SWP dedicated pin |

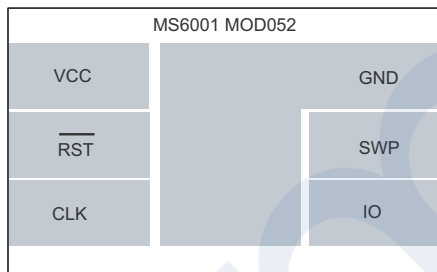

QFN20

| | |
|--|------------------------------|
| GND | Ground (reference voltage) |
| VCC | Power supply input |
| IO1 / $\overline{\text{SS}}$ | IO1 or SPI Slave Select |
| GPIO0 / MOSI | GPIO0 or SPI MOSI |
| GPIO1 / MISO | GPIO1 or SPI MISO |
| GPIO2 / SCK | GPIO2 or SPI clock |
| SDA | I2C SDA |
| SCL | I2C SCL |
| SWP | Single Wire Protocol |
| IO0 / ISO_IO | IO0 or ISO IO |
| ISO_CLK | ISO CLK ISO 7816 input clock |
| $\overline{\text{RST}}$ | Reset |

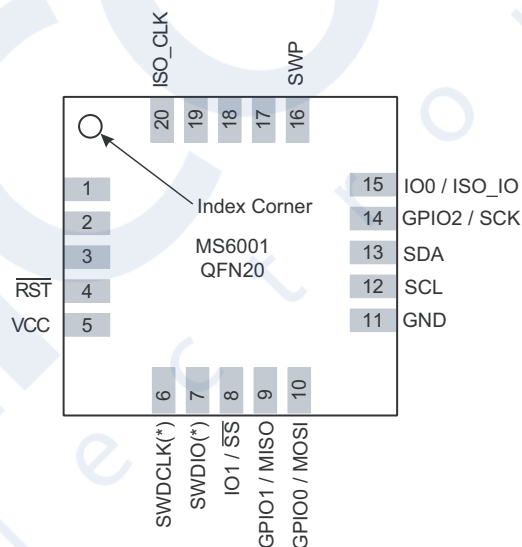

| | |
|------------------|-------------------------|
| SWDCLK(*) | Single Wire Debug Clock |
| SWDIO(*) | Single Wire Debug IO |

(*) only for engineering sample

| Configuration | Interfaces Available | Package |
|---------------|---|-------------|
| QFN20 | ISO (or 1 GPIO) + SWP + I2C + SPI (or 4 GPIO) | QFN20 (4*4) |

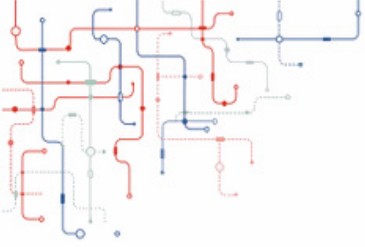

Package outline

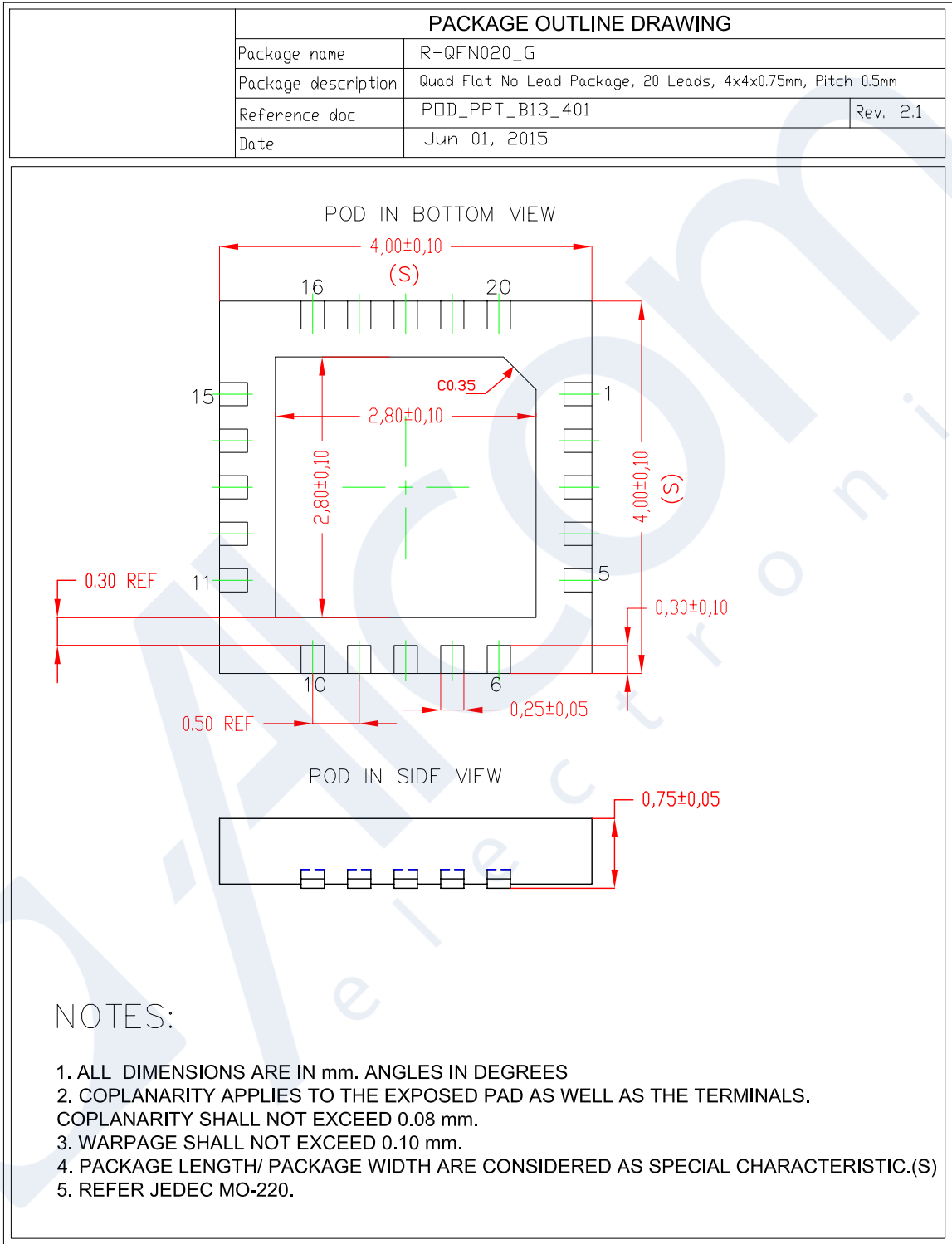

The photographs and information contained in this document are not contractual and may be changed without notice. Brand and product names may be registered trademarks or trademarks of their respective holders.
 Note: This is a summary document. A complete document will be available under NDA. For more information, please contact your local WiseKey sales office.



Singel 3 | B-2550 Kontich | Belgium | Tel. +32 (0)3 458 30 33 | info@alcom.be | www.alcom.be
 Rivium 1e straat 52 | 2909 LE Capelle aan den IJssel | The Netherlands | Tel. +31 (0)10 288 25 00 | info@alcom.nl | www.alcom.nl

6631CS - 18Jun18