

Salud Series White COB LED Arrays

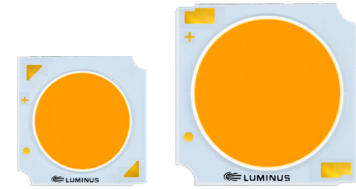

Contents

Part Number Nomenclature 2
CCT, CRI & R9 Specification. .2
Chromaticity Bin Structure .3
Ordering Part Numbers.4
Operating Characteristics . .6
Optical and Electrical Characteristics8
Typical Spectrum 12
Radiation Pattern 13
Mechanical Dimension . . . 13
Shipping Container 15
Label Information 15
Technology Review 16
Test Specifications 16
Handling Notes 17

Features:

- Specially engineered to deliver high Melanopic Flux
- High Melanopic/Photopic ratios for all CCTs especially low values
- All Products CRI values > 90
- LES sizes from 6mm to 22mm
- CCT 3000K, 3500K, 4000K, 5000K
- Excellent optical emission uniformity and color over angle consistency
- Exceptional long term color stability
- Superior thermal conductivity for uniform heat spreading
- Environmentally friendly: RoHS and REACH compliant



Applications

- Architectural And Specialty
- Spotlights/Track Lights
- Downlights
- Low Blue Spectrum Lamps
- Hospitality Lighting
- Museum
- Human Centric Lighting



Part Number Nomenclature

All Luminus COB products are packaged and labeled with part numbers as outlined in the table on page 4. Luminus may include any smaller chromaticity bin that is contained in the larger bin as part of the ordered part. When shipped, each package will contain only a single flux and chromaticity bin. The part number designation is as follows:

CXM	—	6	—	NN	—	XX	—	VV	—	QQPP	—	FG	—	W
Product Family	LES ¹	CCT ²	Min. CRI ³	Typical Voltage	Package Configurator ⁴	Flux Bin	Chromaticity Bin							
Chip on Board, Multi-die	6.3mm LES diameter	See Note 2 below	CRI See Table Below	Volts (V)	TU31	Lumens	See page 3 for bins							

Notes:

1. Light Emitting Surface (LES) Diameter.

- 6 = 6.3mm
- 9 = 9.8mm
- 11 = 11.7mm
- 14 = 14.5mm
- 22 = 22mm

2. Correlated Color Temperature (CCT), NN nomenclature corresponds to the following:

- 30 = 3000K
- 35 = 3500K
- 40 = 4000K
- 50 = 5000K

3. Minimum Color Rendering Index (CRI).

4. T is a standard substrate; U refers to Salud COB; 3 indicates Generation 3 platform COB, 1 indicates the chromaticity is below the Black Body Locus (BBBL).

5. Luminus part numbers may be accompanied by prefixes or suffixes. The most common is the "Rev01" suffix indicating a part is fully released and carries a full warranty. These additional characters may appear on shipping labels, packing slips and invoices. In all cases the basic part number described above will always be included.

CCT, CRI, R9 and M/P Values

Correlated Color Temperatures	XX Value	CRI	*R9 (Min.)	R9 (Typ.)	M/P (Typ.)
3000K	90	>90	>85	92	0.65
3500K	90	>90	>90	95	0.74
4000K	90	>90	>90	98	0.85
5000K	90	>90	>90	97	1.03

Note: R9 values have a tolerance of +/- 5%



Chromaticity Bin Structure
Chromaticity Bins: 1931 CIE Color Space

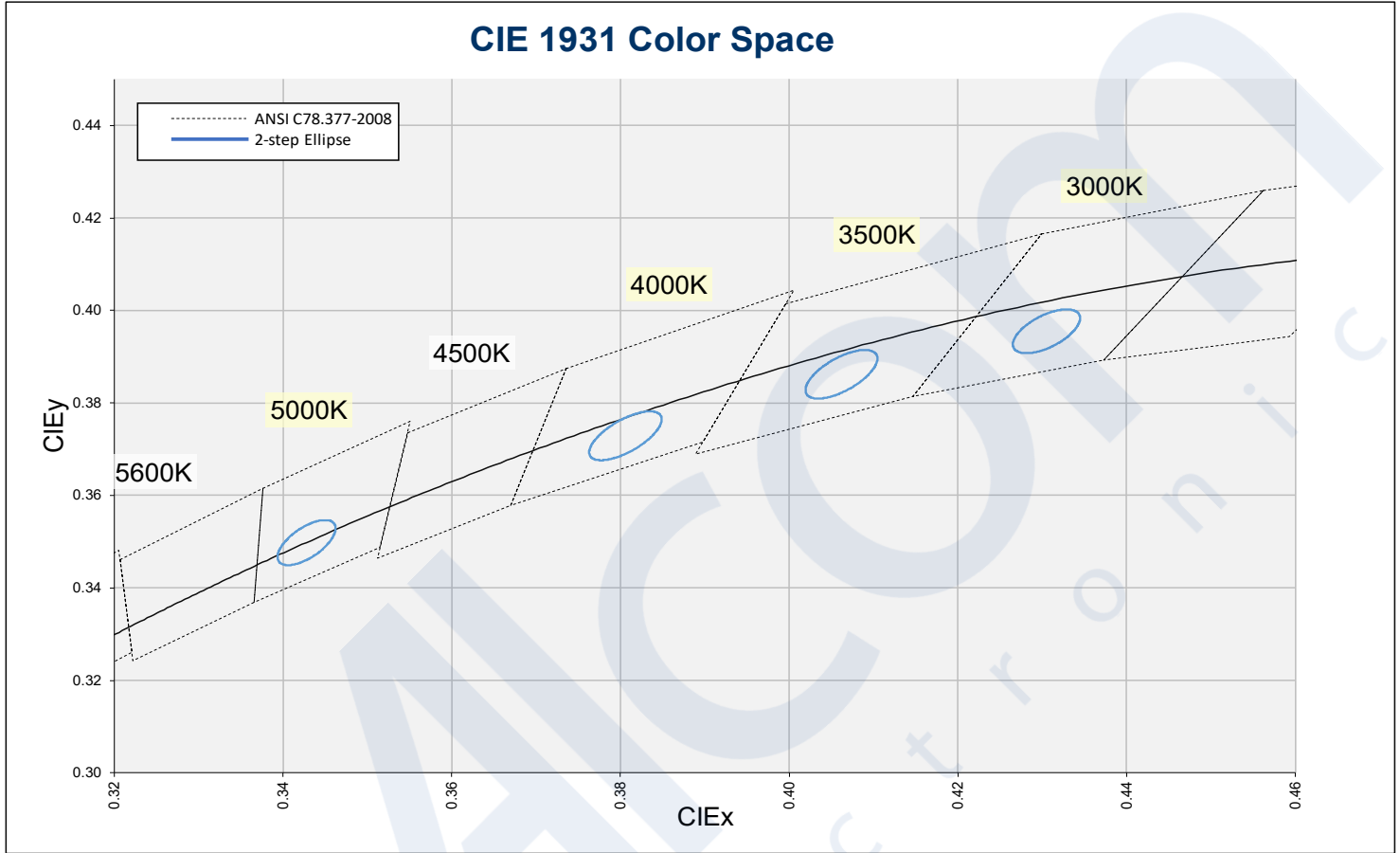

The following tables describe the chromaticity bin center points, the orientation angle for the MacAdam ellipse (θ°), and the maximum radii for the ellipses. The ANSI Bins are shown in the graph for reference.

CCT	Center Point		Angle	2-step Bin	
	CIE _x	CIE _y	θ°	a	b
3000K	0.4305	0.3955	53.2	0.00556	0.00272
3500K	0.4062	0.3862	54.0	0.00618	0.00276
4000K	0.3806	0.3729	53.7	0.00626	0.00268
5000K	0.3428	0.3498	59.6	0.00548	0.00236

Note: Luminus maintains a +/- 0.005 tolerance on chromaticity (CIE_x and CIE_y) measurements



Ordering Part Numbers - Salud

The following tables describe products with typical flux and minimum flux measured at typical current and specified at $T_j = 85^\circ\text{C}$. The values at 25°C are calculated and shown for reference only.

Output Flux (lm)			LES Diameter (mm)	Typ. Current (mA)	2-step MacAdam Ellipse
Typ. (85°C)	Min. (85°C)	Calculated Typ. (25°C)			
530	490	580	6.3	150	CXM-6-30-90-36-TU31-F4-2
565	525	620			CXM-6-35-90-36-TU31-F4-2
570	530	630			CXM-6-40-90-36-TU31-F4-2
585	545	645			CXM-6-50-90-36-TU31-F4-2
530	490	580	6.3	300	CXM-6-30-90-18-TU31-F4-2
565	525	620			CXM-6-35-90-18-TU31-F4-2
570	530	630			CXM-6-40-90-18-TU31-F4-2
585	545	645			CXM-6-50-90-18-TU31-F4-2
1,310	1,220	1,440	9.8	360	CXM-9-30-90-36-TU31-F4-2
1,395	1,295	1,535			CXM-9-35-90-36-TU31-F4-2
1,415	1,315	1,555			CXM-9-40-90-36-TU31-F4-2
1,450	1,350	1,595			CXM-9-50-90-36-TU31-F4-2

*Note: Luminus maintains a +/- 6% tolerance on flux measurements.
Luminus maintains a +/- 2% tolerance on CRI measurements.*



Ordering Part Numbers - Salud

The following tables describe products with typical flux and minimum flux measured at typical current and specified at $T_j = 85^\circ\text{C}$. The values at 25°C are calculated and shown for reference only.

Output Flux (lm)			LES Diameter (mm)	Typ. Current (mA)	2-step MacAdam Ellipse
Typ. (85°C)	Min. (85°C)	Calculated Typ. (25°C)			
1,630	1,515	1,795	11.7	450	CXM-11-30-90-36-TU31-F4-2
1,735	1,615	1,910			CXM-11-35-90-36-TU31-F4-2
1,760	1,635	1,935			CXM-11-40-90-36-TU31-F4-2
1,810	1,680	1,990			CXM-11-50-90-36-TU31-F4-2
2,590	2,405	2,845	14.5	720	CXM-14-30-90-36-TU31-F4-2
2,755	2,565	3,030			CXM-14-35-90-36-TU31-F4-2
2,795	2,600	3,070			CXM-14-40-90-36-TU31-F4-2
2,870	2,670	3,155			CXM-14-50-90-36-TU31-F4-2
4,235	3,940	4,660	22	1050	CLM-22-30-90-36-TU31-F4-2
4,510	4,195	4,965			CLM-22-35-90-36-TU31-F4-2
4,570	4,250	5,030			CLM-22-40-90-36-TU31-F4-2
4,700	4,370	5,165			CLM-22-50-90-36-TU31-F4-2

*Note: Luminus maintains a +/- 6% tolerance on flux measurements.
Luminus maintains a +/- 2% tolerance on CRI measurements.*



CXM-6 Operating Characteristics¹

Parameter - 36V	Symbol	Minimum	Typical	Maximum	Unit
Forward Current ²	I_f		150	300	mA
Forward Voltage ³	V_f	31.0	33.5	37.0	V
Parameter - 18V	Symbol	Minimum	Typical	Maximum	Unit
Forward Current ²	I_f		300	600	mA
Forward Voltage ³	V_f	15.5	16.2	18.5	V
Power			5.0	12	W
Operating Case Temperature	T_c			105	°C
Light Emitting Surface Diameter	LES		6.3		mm
Thermal Resistance (junction-to-case)	Θ_{jc}		1.0		°C/W
Junction Temperature	T_j			140	°C
Viewing Angle			120		Degree

CXM-9 Operating Characteristics¹

Parameter	Symbol	Minimum	Typical	Maximum	Unit
Forward Current ²	I_f		360	720	mA
Forward Voltage ³	V_f	31.0	33.5	37.0	V
Power			12.1	26.6	W
Operating Case Temperature	T_c			105	°C
Light Emitting Surface Diameter ⁴	LES		9.8		mm
Thermal Resistance (junction-to-case)	Θ_{jc}		0.5		°C/W
Junction Temperature	T_j			140	°C
Viewing Angle			120		Degree

CXM-11 Operating Characteristics¹

Parameter	Symbol	Minimum	Typical	Maximum	Unit
Forward Current ²	I_f		450	900	mA
Forward Voltage ³	V_f	31	33.5	37	V
Power			15.2	40.5	W
Operating Case Temperature	T_c			105	°C
Light Emitting Surface Diameter	LES		11.7		mm
Thermal Resistance (junction-to-case)	Θ_{jc}		0.35		°C/W
Junction Temperature	T_j			140	°C
Viewing Angle			120		Degree



CXM-14 Operating Characteristics¹

Parameter	Symbol	Minimum	Typical	Maximum	Unit
Forward Current ²	I_f		720	1,440	mA
Forward Voltage ³	V_f	31.0	33.5	37.0	V
Power			24.1	53.5	W
Operating Case Temperature	T_c			105	°C
Light Emitting Surface Diameter	LES		14.5		mm
Thermal Resistance (junction-to-case)	Θ_{jc}		0.23		°C/W
Junction Temperature	T_j			140	°C
Viewing Angle			120		Degree

CLM-22 Operating Characteristics¹

Parameter	Symbol	Minimum	Typical	Maximum	Unit
Forward Current ²	I_f		1,050	2,100	mA
Forward Voltage ³	V_f	31.0	33.5	37.0	V
Power			35.2	77.7	W
Operating Case Temperature	T_c			105	°C
Light Emitting Surface Diameter	LES		22.0		mm
Thermal Resistance (junction-to-case)	Θ_{jc}		0.16		°C/W
Junction Temperature	T_j			140	°C
Viewing Angle			120		Degree

Notes:

1. Ratings are based on operation at a constant junction temperature of $T_j = 85^\circ\text{C}$.
2. To prevent damage refer to operating conditions and derating curves for appropriate maximum operating conditions
3. Voltage is rated at typical forward current. For voltage at higher drive current, refer to performance graphs.
4. Device operation not recommended at drive currents less than 10% of the typical value
5. Caution must be taken not to stare at the light emitted from these LEDs. Under special circumstances, the high intensity could damage the eye.
6. All product operating specifications are subject to change without advance notice.



CXM-6, 36V Optical & Electrical Characteristics

Relative Output Flux vs. Forward Current @ 85°C

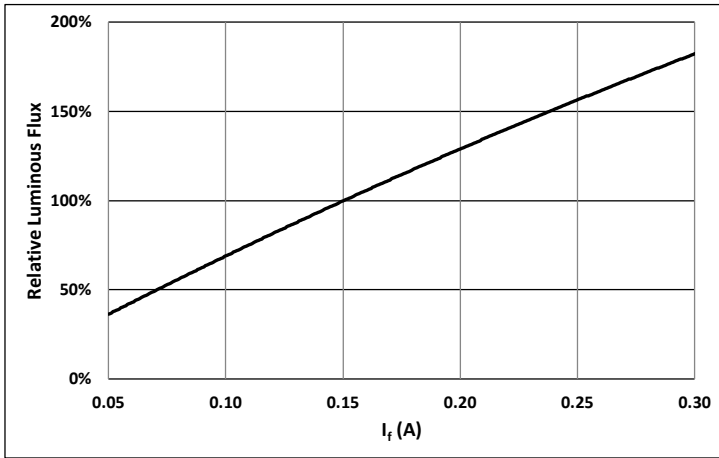

Forward Voltage vs. Forward Current @ 85°C

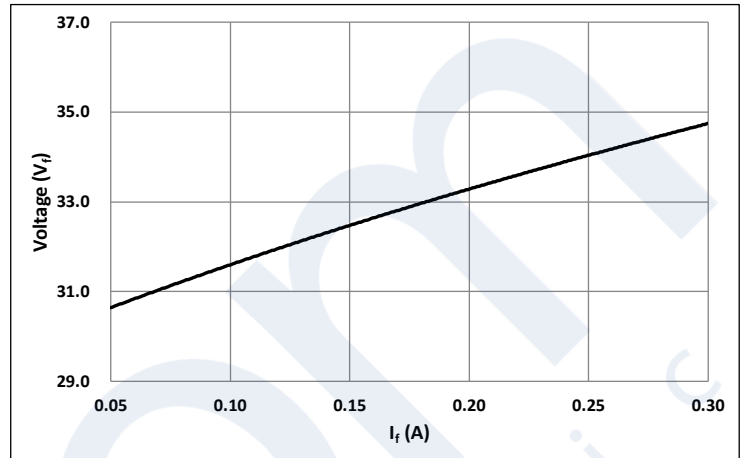

Relative Output Flux vs. Junction Temperature

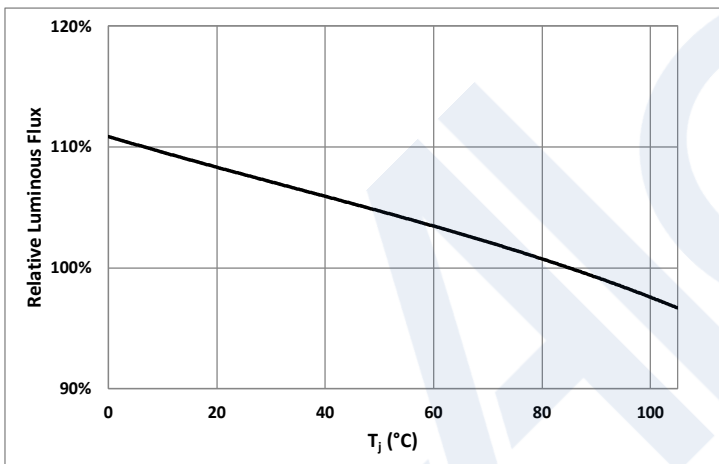

Change in Voltage vs. Junction Temperature

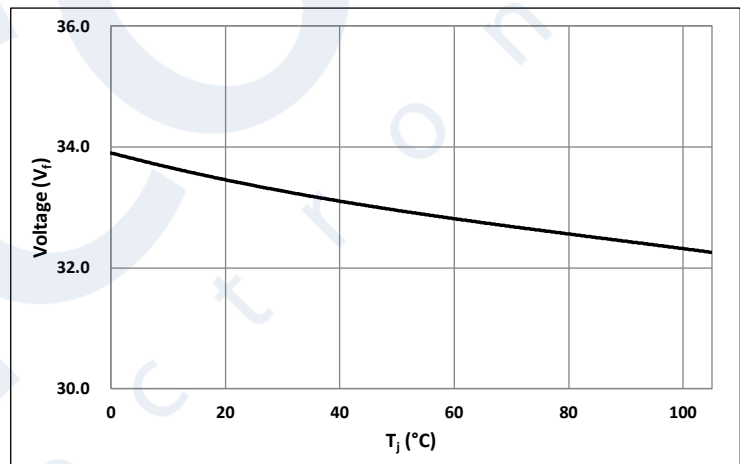

CXM-6, 18V Optical & Electrical Characteristics

Relative Output Flux vs. Forward Current @ 85°C

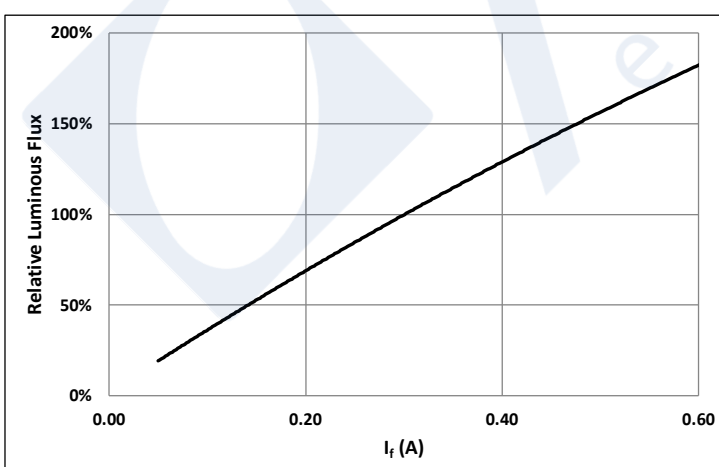

Forward Voltage vs. Forward Current @ 85°C

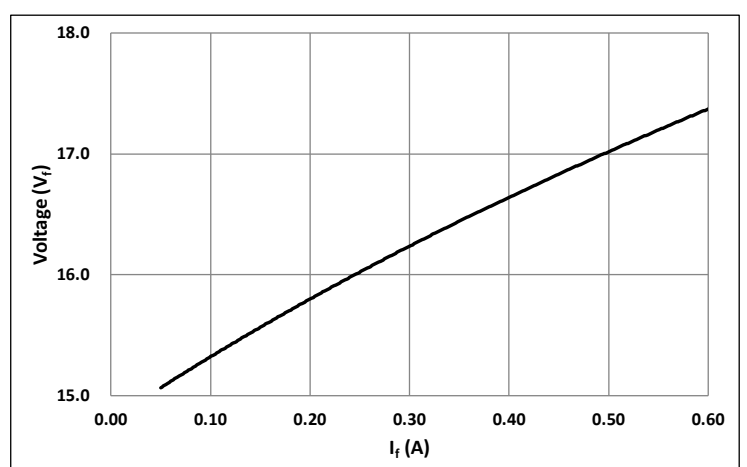



CXM-6 18V Optical & Electrical Characteristics

Relative Output Flux vs. Junction Temperature

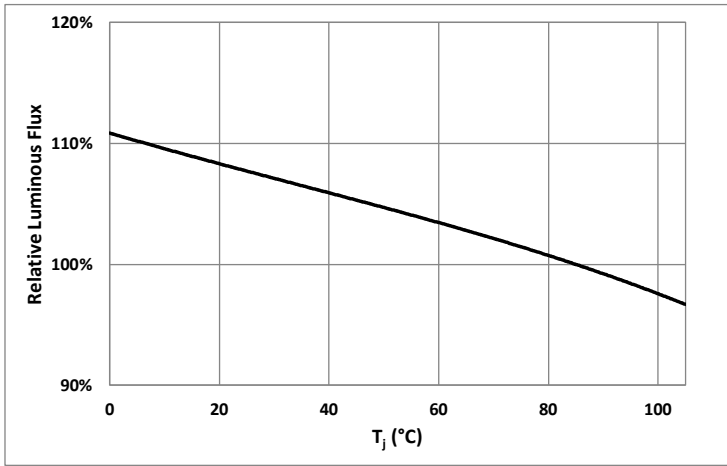

Change in Voltage vs. Junction Temperature

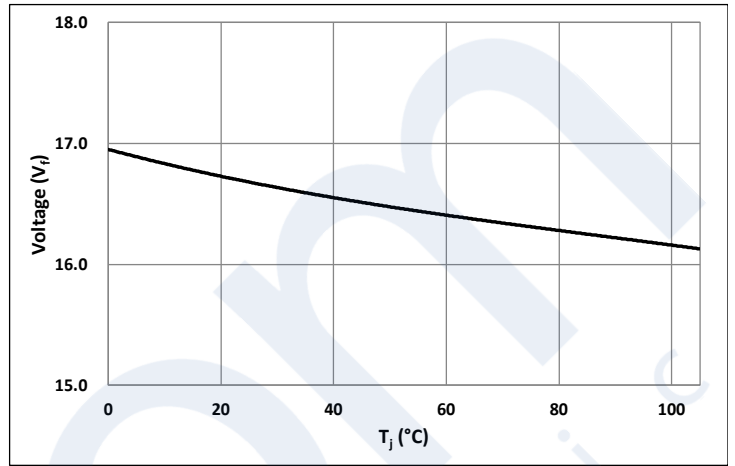

CXM-9 Optical & Electrical Characteristics

Relative Output Flux vs. Forward Current @ 85°C

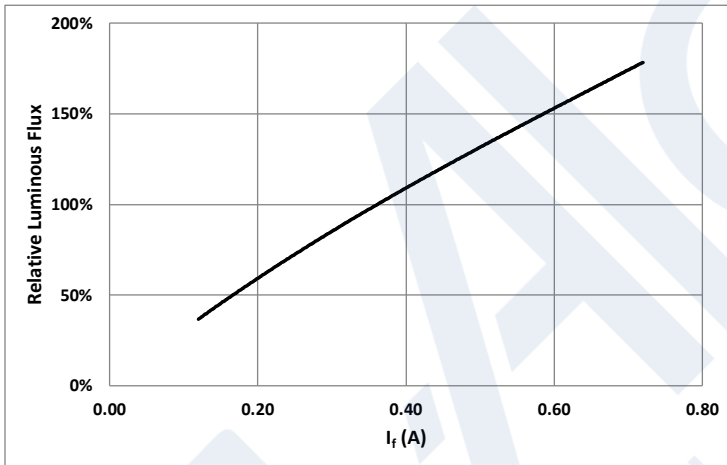

Forward Voltage vs. Forward Current @ 85°C

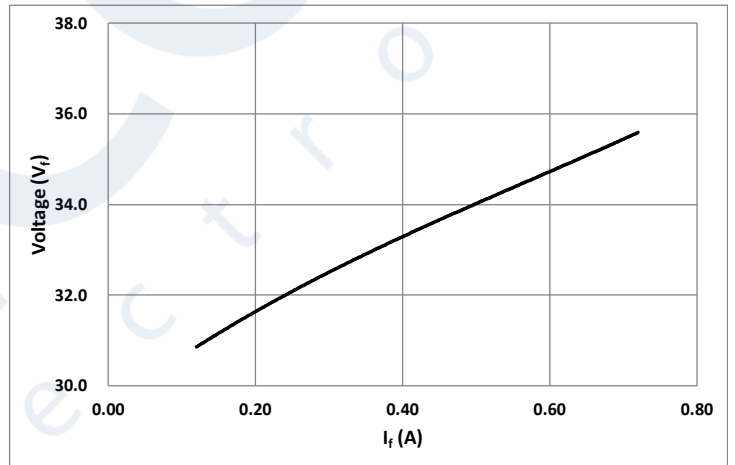

Relative Output Flux vs. Junction Temperature

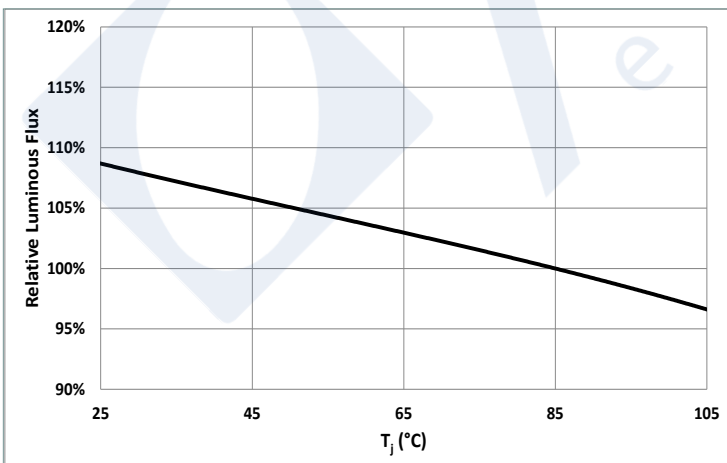

Change in Voltage vs. Junction Temperature

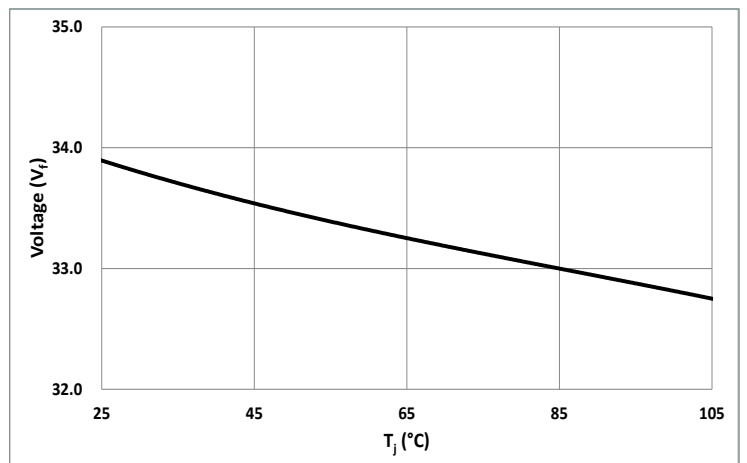



CXM-11 Optical & Electrical Characteristics

Relative Output Flux vs. Forward Current @ 85°C

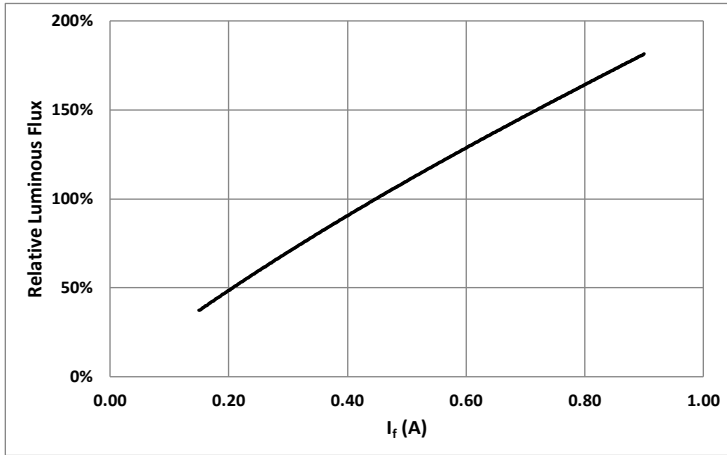

Forward Voltage vs. Forward Current @ 85°C

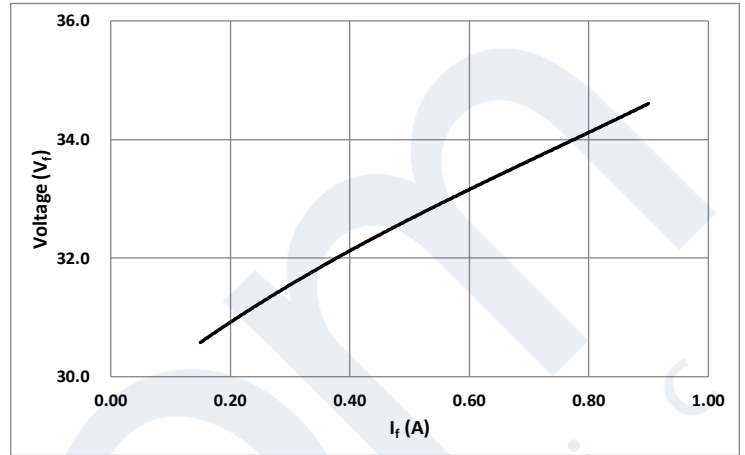

Relative Output Flux vs. Junction Temperature

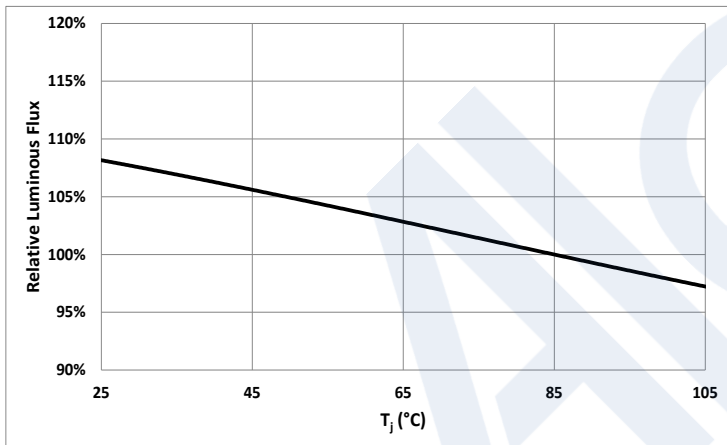

Change in Voltage vs. Junction Temperature

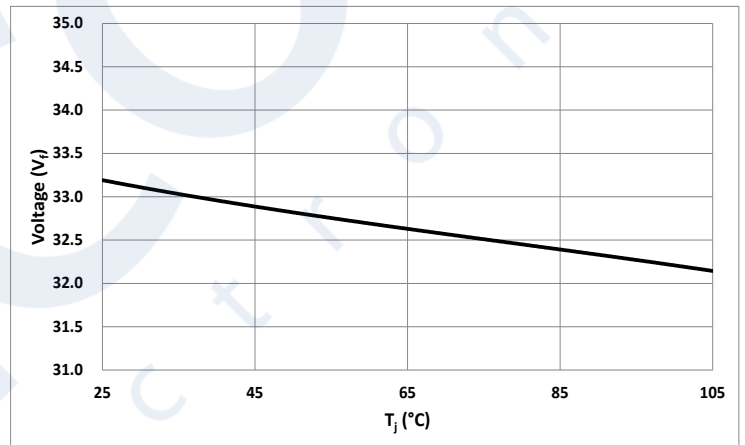

Change in CIE_x/y vs. Junction Temp. (3000K, 90CRI)

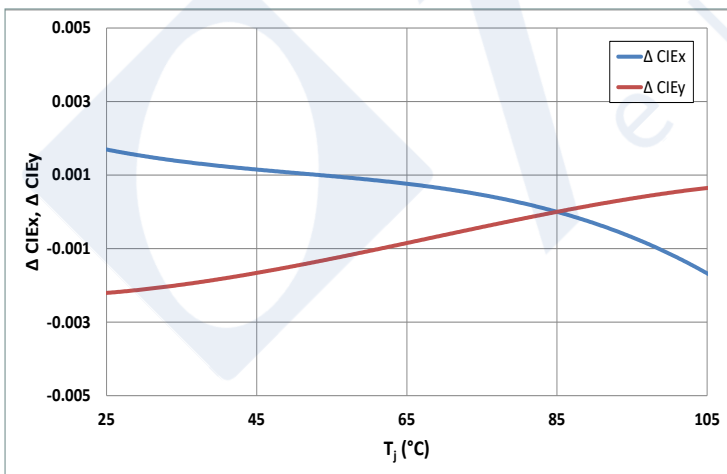

Change in CIE_x/y vs. Forward Current (3000K, 90CRI)

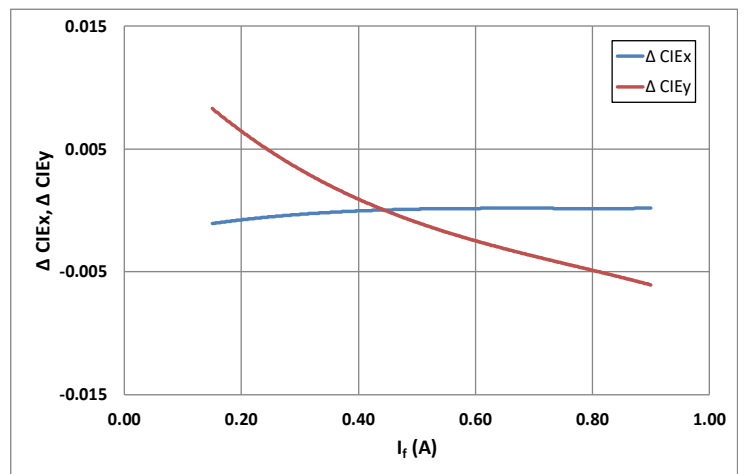



CXM-14 Optical & Electrical Characteristics

Relative Output Flux vs. Forward Current @ 85°C

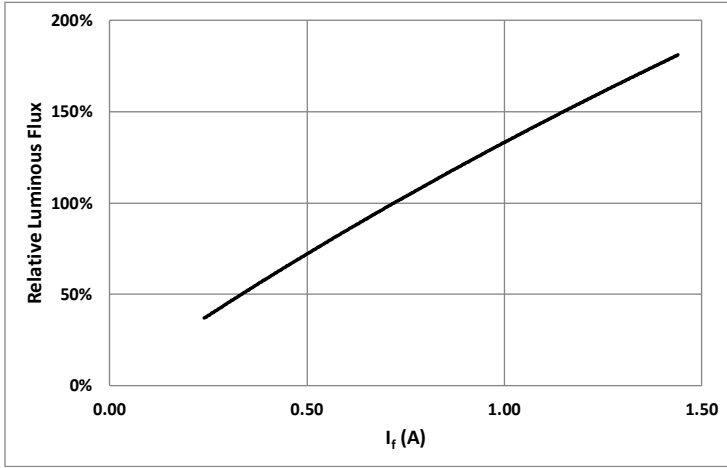

Forward Voltage vs. Forward Current @ 85°C

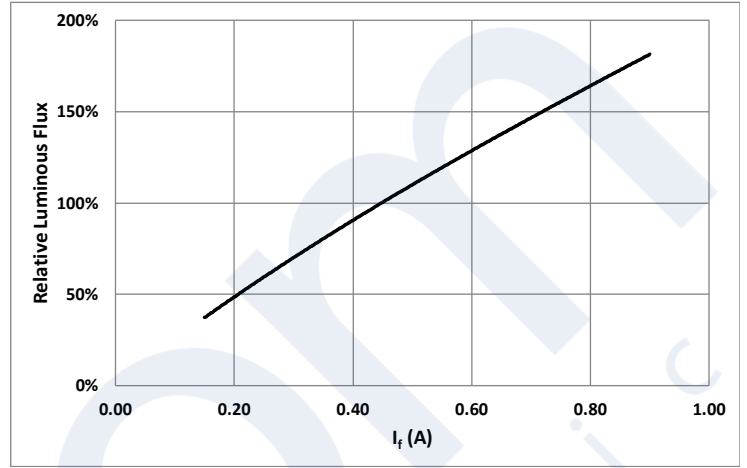

Relative Output Flux vs. Junction Temperature

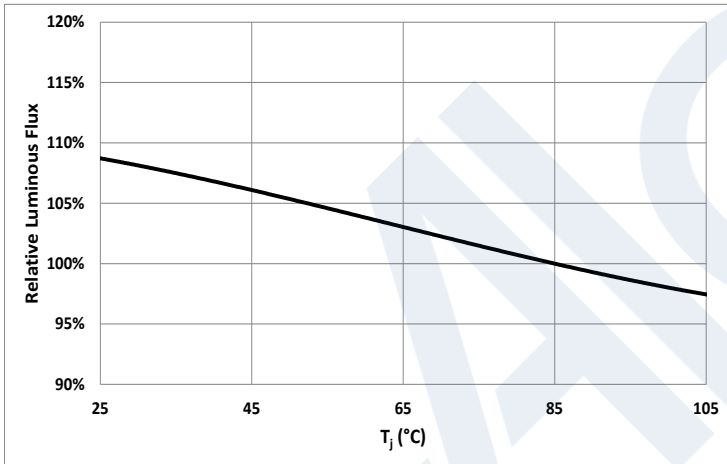

Change in Voltage vs. Junction Temperature

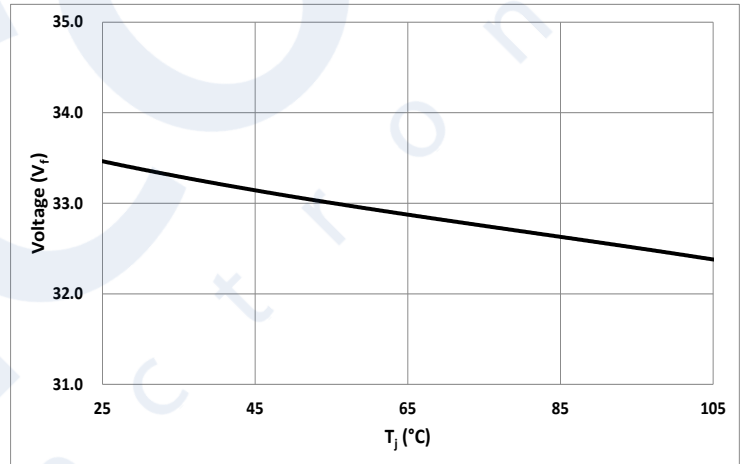

Change in CIE_x/y vs. Junction Temp. (3000K, 90CRI)

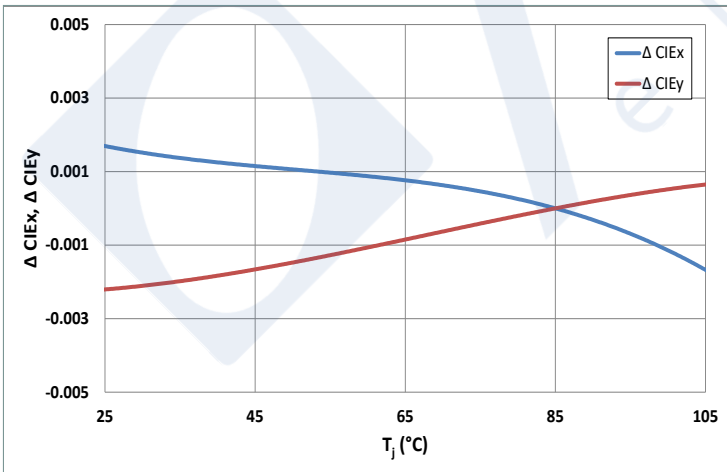

Change in CIE_x/y vs. Forward Current (3000K, 90CRI)

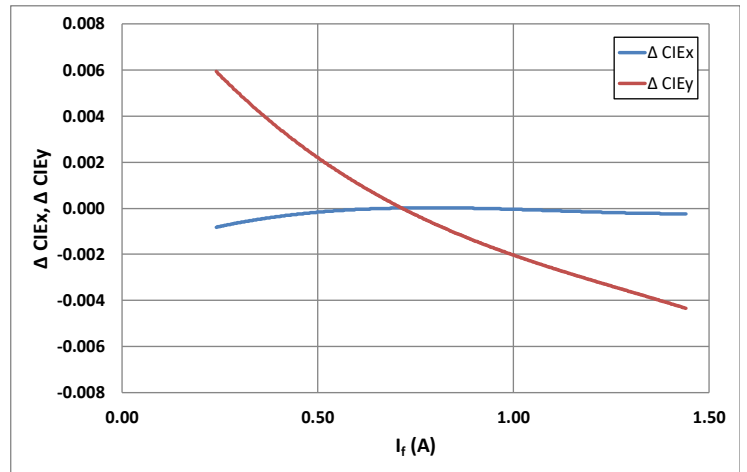



CLM-22 Optical & Electrical Characteristics

Relative Output Flux vs. Forward Current @ 85°C

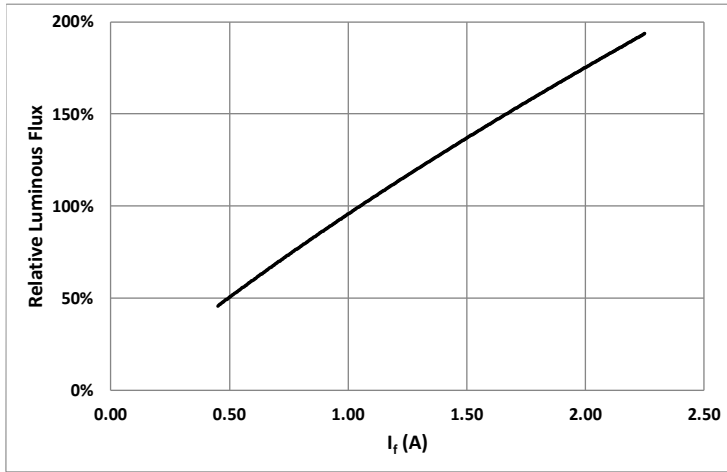

Forward Voltage vs. Forward Current @ 85°C

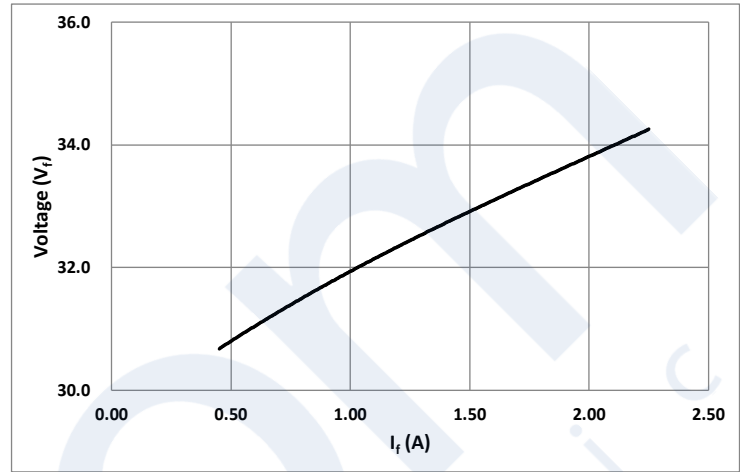

Relative Output Flux vs. Junction Temperature

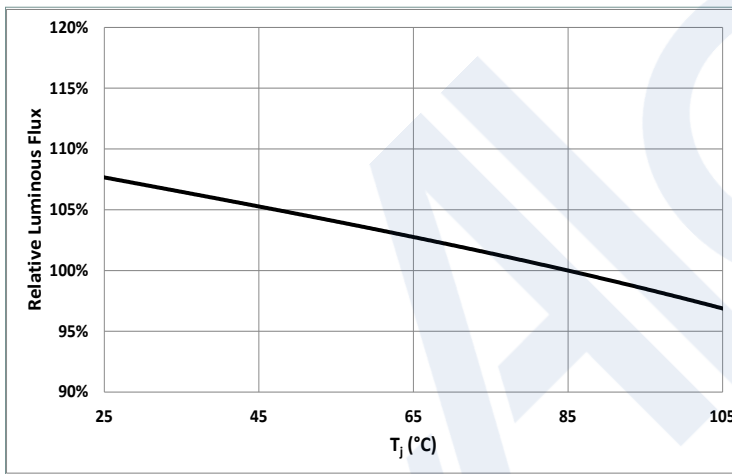

Change in Voltage vs. Junction Temperature

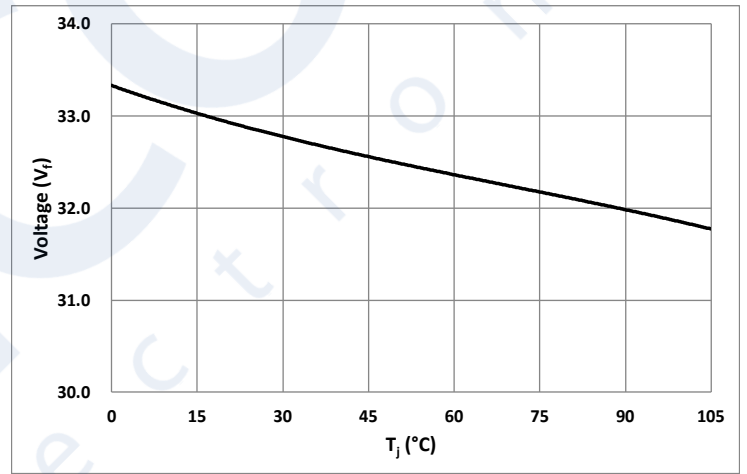

Change in CIE_x/y vs. Junction Temp. (3000K, 90CRI)

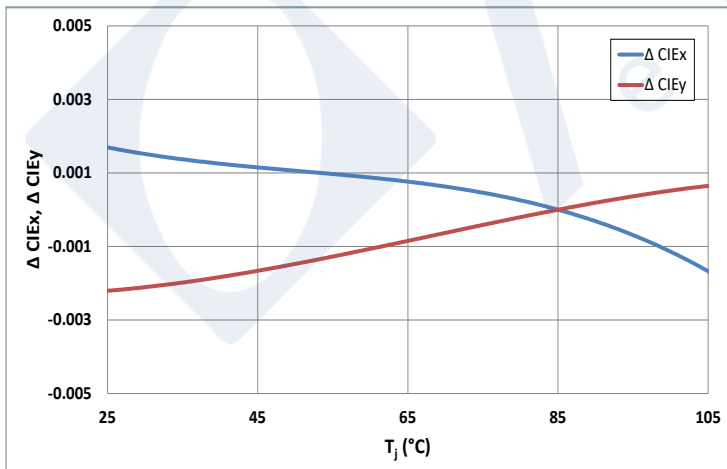

Change in CIE_x/y vs. Forward Current (3000K, 90CRI)

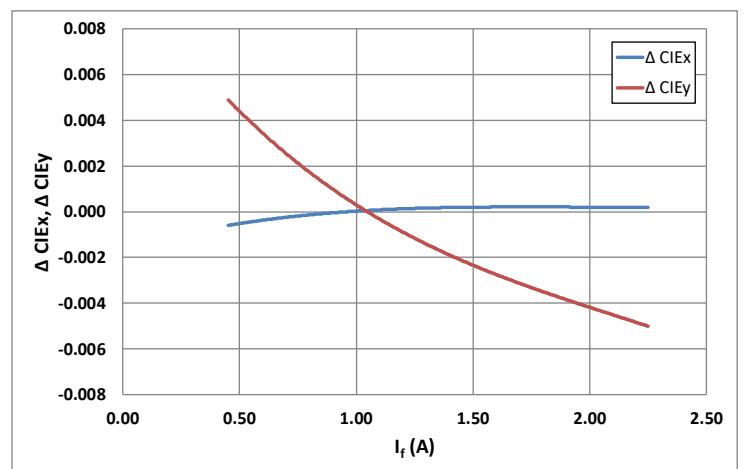



Typical Spectrum¹

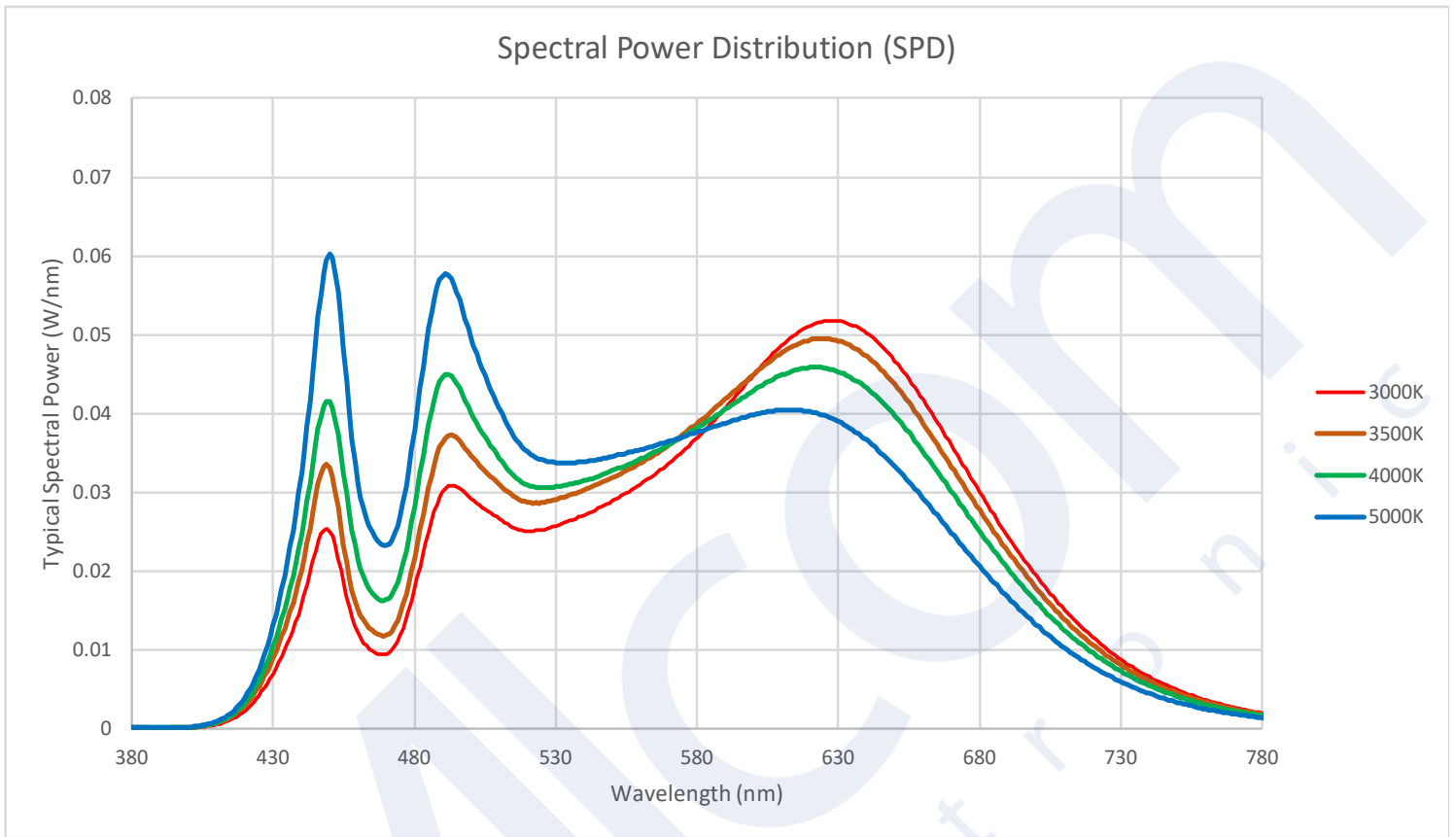

Radiation Pattern

Typical Polar Radiation Pattern

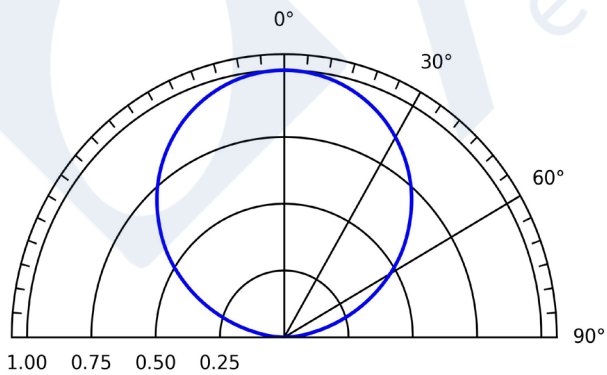

Typical Angular Radiation Pattern

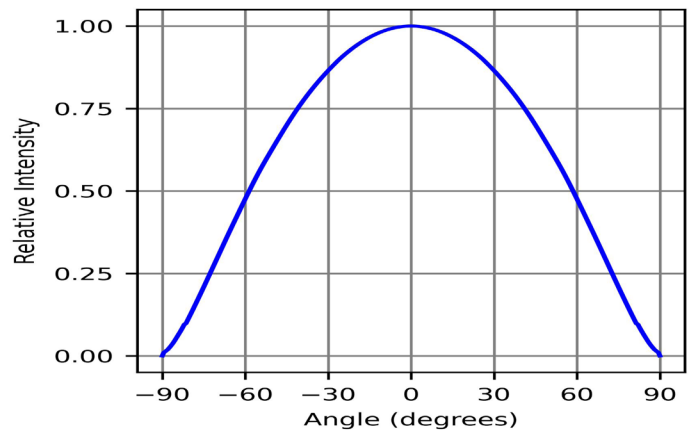



Mechanical Dimensions CXM-6-TU Series

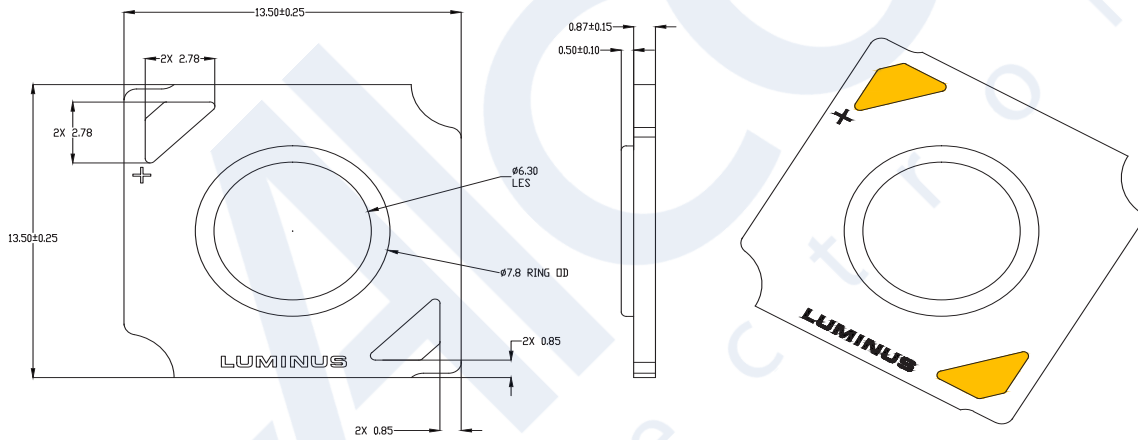

Mechanical Dimensions CXM-9-TU Series

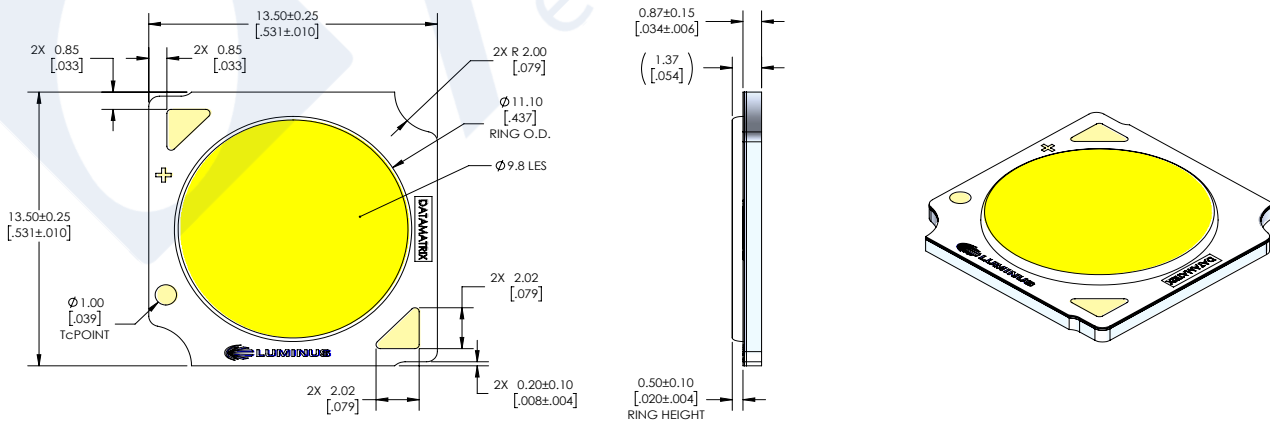



Mechanical Dimensions CXM-11-TU Series

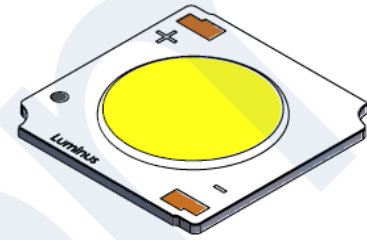
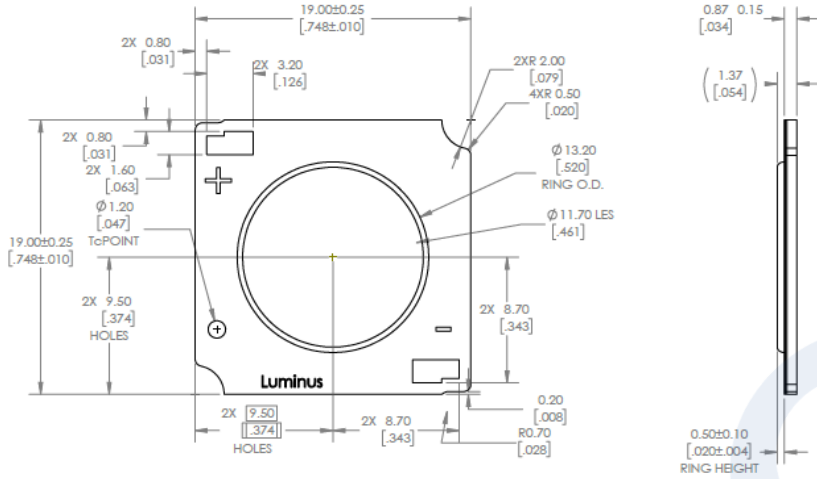

CXM-14-TU Series

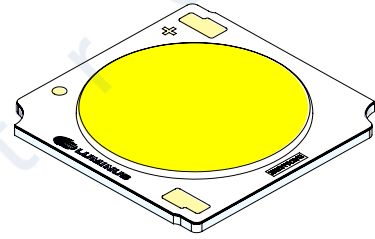
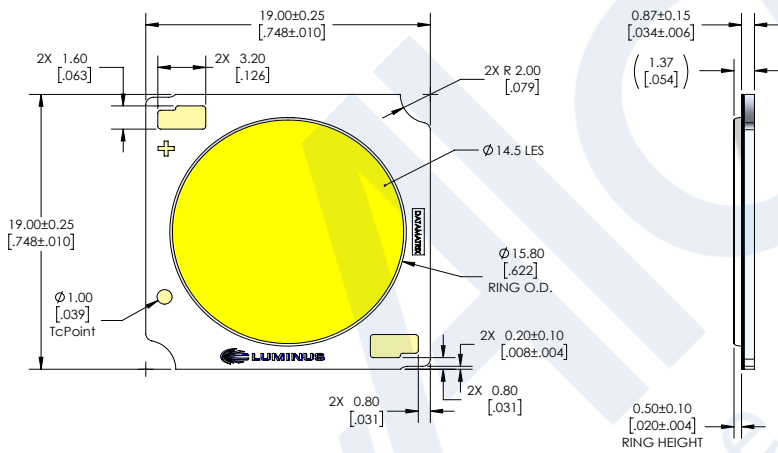

CLM-22-TU Series

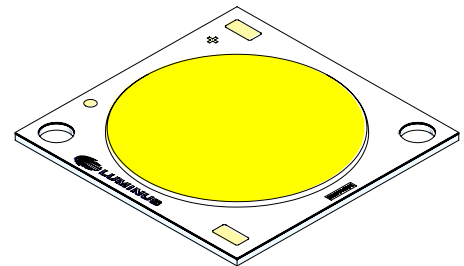
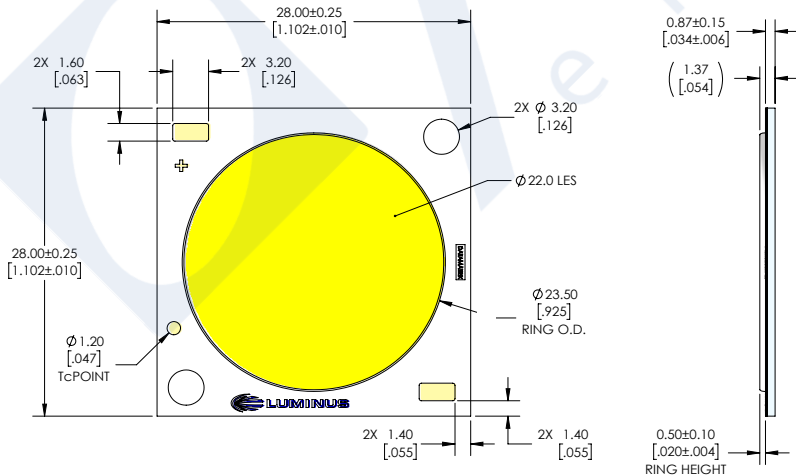

Note: Unless otherwise specified, tolerance is ± 0.3mm

CXM-6, CXM-9-TU Shipping Container



Package model -- for illumination

Note: 80 pcs per tray and 5 trays are stacked together to be sealed in an anti-static bag.



Note: The anti-static bag is boxed for easier storage, 400 pcs per box.

CXM-11, CXM-14-TU Shipping Container



Package model -- for illumination

Note: 45 pcs per tray and 5 trays are stacked together to be sealed in an anti-static bag.



Note: The anti-static bag is boxed for easier storage, 225 pcs per box.

CLM-22 Shipping Container



Package model -- for illumination

Note: 20 pcs per tray and 5 trays are stacked together to be sealed in an anti-static bag.



Note: The anti-static bag is boxed for easier storage, 100 pcs per box.

Label Information

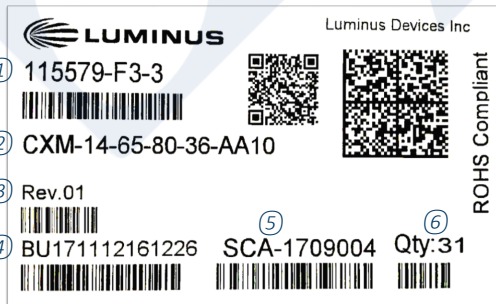

Label model -- for illustration purposes only

Notes:

- ① Manufacturers part number, flux bin and chromaticity bin
- ② Customer part number
- ③ Rev.01 indicates a fully released product
- ④ Box ID
- ⑤ Production ID
- ⑥ Total number of units in a box



Technology Overview

Luminus Chip-on-Board (COB) Salud Series LEDs are engineered to deliver high melanopic/photopic (M/P) ratio performance to enable more human centric light sources. The carefully crafted devices are able to deliver M/P ratios with as much as 2x the values for the warmest CCTs. This is done while maintaining CRI > 90 and R9 values over 85 in all cases and >90 in many.

Reliability

Designed from the ground up, the Luminus COB LED is one of the most reliable light sources in the world today.

UL Recognized Compliance

Luminus COB arrays are tested in accordance with ANSI/UL 8750 to ensure safe operation for their intended applications.

REACH & RoHS Compliance

All LED products manufactured by Luminus are REACH and RoHS compliant and free of hazardous materials, including lead and mercury.

Test Specifications

Every Luminus LED is fully tested to ensure it meets the high quality standards customers have come to expect from Luminus' products.

Traceability

Each Luminus COB LED is marked with a 2D bar code that contains a unique serial number. With this serial number, Luminus has the ability to provide customers with actual test data measurements for a specific LED. In addition, the 2D bar code is linked to manufacturing date codes that enables traceability of production processes and materials.

Testing Temperature

Luminus COB products are measured at temperatures typical for the LED operating in the fixture. Each device is tested at 85°C junction temperature eliminating the need to scale data sheet specifications to real world situations.

Chromaticity Bin Range

Chromaticity binning delivers color consistency for every order. Standard products are delivered with a 3-step MacAdam ellipse. This ensures color performance matching in the application. For the most demanding application, Luminus is one of only a few companies that can provide a 2 SCDM bin distribution. These tightly controlled, small distribution bins provide customers predictable, repeatable colors.



Handling Notes

Luminus products are designed for robust performance in general lighting application. However, care must be taken when handling and assembling the LEDs into their fixtures. To avoid damaging Luminus COBs please follow these guidelines.

The following is an overview of the application notes detailing some of the practices to follow when working with these devices. More detailed information is available on the Luminus web site at www.luminus.com.

General Handling

Devices are made to be lifted or carried with tweezers on two adjacent corners opposite the contact pads. At no time should the devices be handled by or should anything come in contact with the light emitting surface (LES) area. This area includes the yellow colored circular area and the ring surrounding it. There are electrical connections under the LES which if damaged will cause the device to fail. In addition, the ring frame itself should not be used for moving, lifting or carrying the device. Also do not attach any optics or mechanical holders to the ring as it is not capable to handle the mechanical stress.

Storage Condition

Please follow the conditions below.

Before opened	Temperature 5~30°C, relative humidity less than 60%.
After opened	Temperature 5~30°C, relative humidity less than 60%. After opening, LED should be kept in an aluminum moisture proof bag with a moisture absorbent material
Avoid Corrosive gas	Avoid exposing to air with corrosive gas. If exposed, electrode surface would be damaged, which may affect soldering. More detailed information is available on the Luminus Applications Resources web pages.

Static Electricity

Luminus COBs are electronic devices which can be damaged by electrostatic discharge (ESD). Please use appropriate measures to assure the devices do not experience ESD during their handling and or storage. ESD protection guidelines should be used at all time when working with Luminus COBs.

Storage	Luminus products are delivered in ESD shielded bags and should be stored in these bags until used
Transporting	When transporting the devices from one assembly area to another, ESD shielded carts and carriers should be used
Assembly	Individuals handling Luminus COBs during assembly should be trained in ESD protection practices. Assemblers should maintain constant conductive contact with a path to ground by means of a wrist strap, ankle straps, mat or other ESD protection system



Chemical Compatibility

The resin material used to form the LES can get hydrocarbons from the surrounding environment. As a result, certain chemical compounds (H₂SO₄, H₂S, SO₂, NH₃, H₃PO₄, etc.) are not recommended for use with the Luminus products. Use of these compounds can cause damage to the light output of the device and may permanently damage the device. Please refer to the table below for a list of the compounds not recommended for use with the Luminus COB products.

Common Chemicals Know to Adversely Affect Luminus Devices		
Acetates	Ethers	Potassium hydroxide
Acetic acid	Cl, F or Br containing compounds	Siloxanes
Acrylates	Liquid hydrocarbons	Sodium Hydroxide
Aldehydes	Hydrochloric Acid	Sulfur compounds
Aldehydes	Ketones	Sulfuric Acid
Amines	Nitric Acid	Toluene
Benzene	Phosphoric acid	Xylenes
Dienes		

Thermal Interface Material (TIM)

Proper thermal management is critical for successful operation of any LED system. Excess operating temperature can reduce the light output of the device. And excessive heating can cause permanent damage to the device. Proper TIM material is a crucial component for effective heat transfer away from the LED during normal operation. Please refer to www.luminus.com for specific recommendations for TIM solutions and the compounds not recommended for use with the Luminus COB products.