



Luminus Dynamic COB Four Channel RGBW Tunable Preliminary Datasheet

RGBW Tunable LED Spot Modules

Features:

- Four channel red, green, blue, and warm white MP-1616 XNOVA Cube LEDs on metal PC board
- High lumen density for directional lighting
- Enables system beam angles from 10 to 40 degrees
- Phosphor converted red and green technology ensures consistency with blue and white LEDs over a wide temperature range and current range
- Specified “hot” performance and 100% factory tested at $T_j=85^{\circ}\text{C}$
- Environmentally friendly: RoHS and REACH compliant

Applications:

- Human centric lighting
- Hospitality / hotel / restaurant lighting
- Residential lighting
- Indoor and outdoor decorative lighting
- Circadian lighting in hospitals, offices, or schools

Products Families

- CTM-9-RGBW-12-TW01: Typical 2W per channel, 9.5mm LES
- CTM-14-RGBW-24-TW01: Typical 4W per channel, 14.5mm LES
 - RGBW = Red, Green, Blue, and 2700K 90 CRI White
 - “12” = 12V typical voltage
 - “24” = 24V typical voltage
 - TW01 = standard configuration

Technical Data

Electrical data @ T_j=85°C

Part number	Nominal forward current per channel	Nominal input power per channel	Nominal voltage per channel	Maximum voltage per channel	Maximum forward current per channel*	Maximum input power per channel*
CTM-9-RGBW-12-TW01	200mA	2W	12V	13V	250mA	3.25W
CTM-14-RGBW-24-TW01	200mA	4W	24V	26V	250mA	6.5W

* Luminaire thermal system capability and power derating curves must be considered. In order to drive all channels simultaneously at nominal current, the luminaire's thermal system must be appropriately engineered to dissipate the thermal load and avoid absolute maximum case temperatures and junction temperatures.

Photometric Data @ T_j=85°C and Nominal Forward Current (200mA):

Part number	Dominant wavelength of blue (min, max)	Minimum flux (lumens)	Nominal flux (lumens)	CCT of warm white		Minimum flux (lumens)	Nominal flux (lumens)
				CRI (min)			
CTM-9-RGBW-12-TW01	455, 460nm	52	58	2700K	90	197	219
CTM-14-RGBW-24-TW01	455, 460nm	104	115	2700K	90	394	438

Part number	Dominant wavelength of red (min, max)	Minimum flux (lumens)	Nominal flux (lumens)	Dominant wavelength of green		
				(min, max)	Minimum flux (lumens)	Nominal flux (lumens)
CTM-9-RGBW-12-TW01	620, 630nm	42	47	525, 535nm	300	325
CTM-14-RGBW-24-TW01	620, 630nm	84	94	525, 535nm	600	650

Chromaticity Bins and Ellipse Definitions @ $T_j=85^\circ\text{C}$:

Nominal CCT	Center Point		Angle	3-step Bin	
	CIEx	CIey	$\Theta(^{\circ})$	a	b
2700K	0.4620	0.4078	54.39	0.00964	0.00421

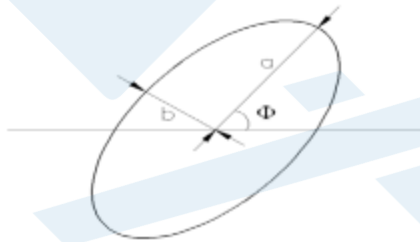

Absolute Maximum Ratings & Optical/Electrical Characteristics:

Parameter	Symbol	Minimum	Typical	Maximum	Unit
Operating case temperature	T_c			105	$^{\circ}\text{C}$
Junction temperature	T_j			125	$^{\circ}\text{C}$
Viewing angle	$2(\Theta/2)$		130		degrees
Reverse voltage	V_r			5	volts
Ambient operating temperature	T_{opr}	-40		+85	$^{\circ}\text{C}$
Storage temperature	T_{sto}	-40		+85	$^{\circ}\text{C}$
Electrostatic Discharge	ESD			2000V	HBM

Mechanical Dimensions & Thermal Resistance:

Part Number	Light Emitting Surface (LES) Diameter	Board Size	Typical Thermal Resistance (Rthj-c)	PCB Thickness
CTM-9-RGBW-12-TW01	9.5mm	12x15mm	1.8 K/W	1mm
CTM-14-RGBW-24-TW01	14.5mm	20x24mm	0.67 K/W	1mm

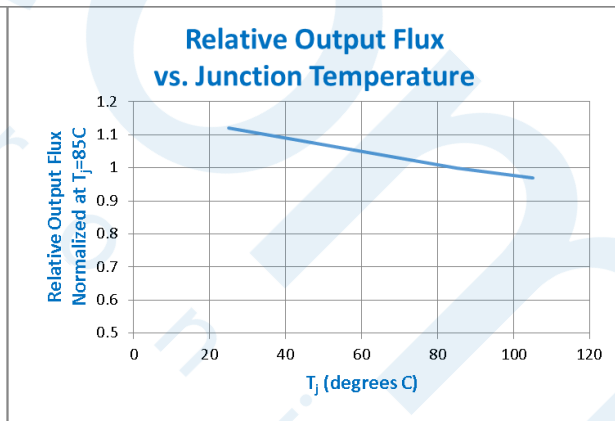
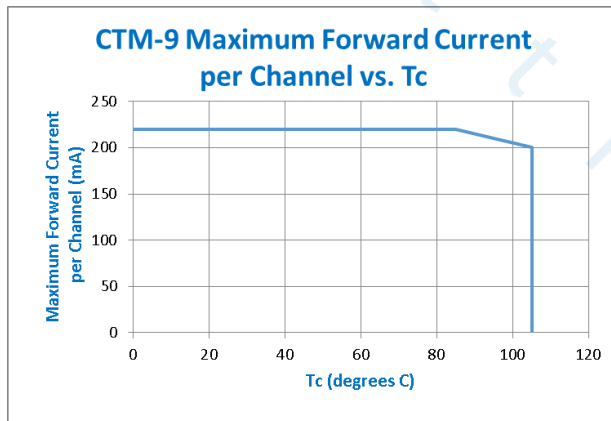
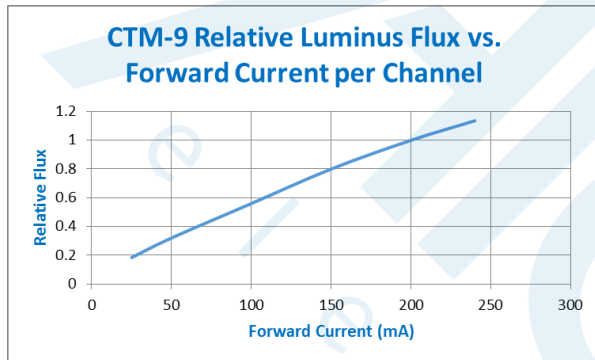

CTM-9 Series Package Dimensions

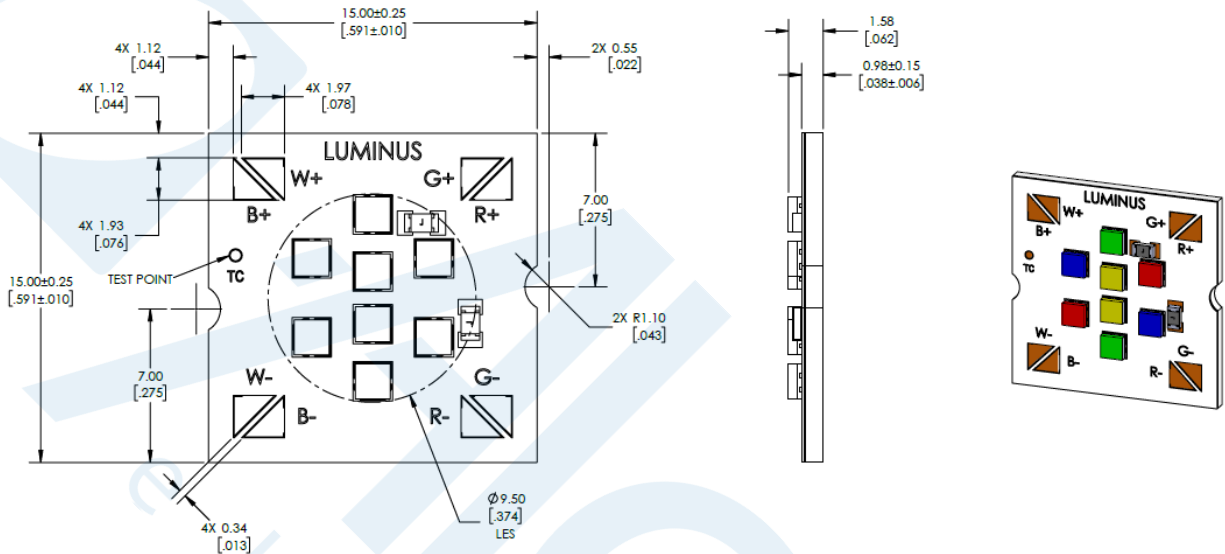

CTM-14 Series Package Dimensions

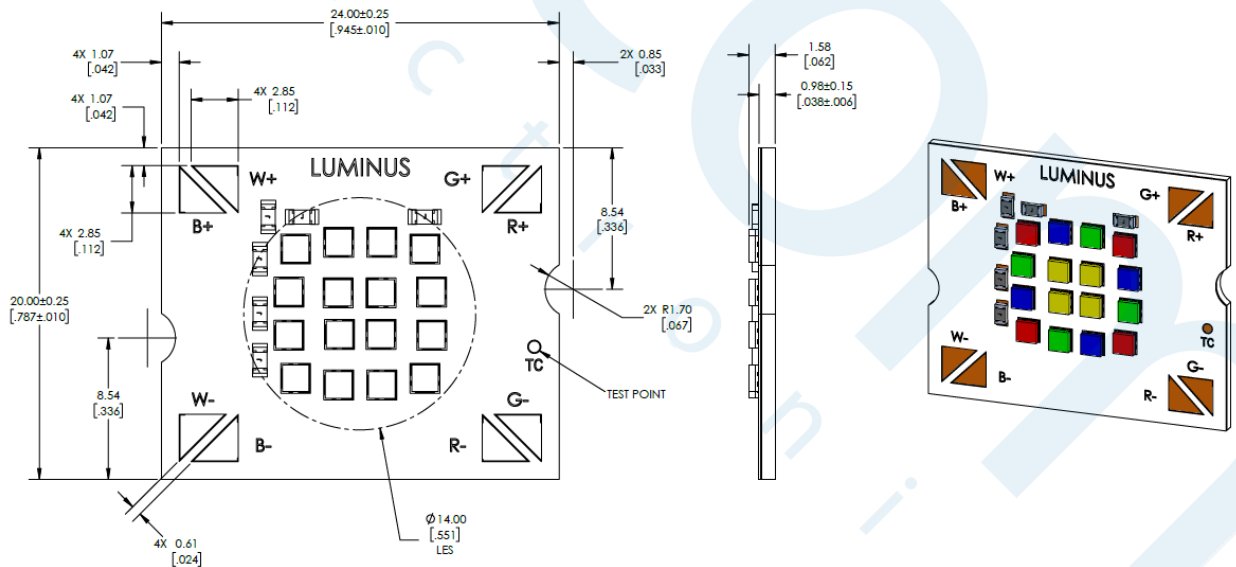

Shipping Container (CTM-9)

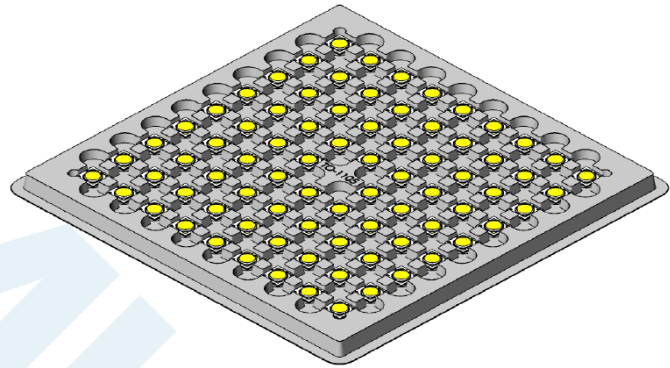
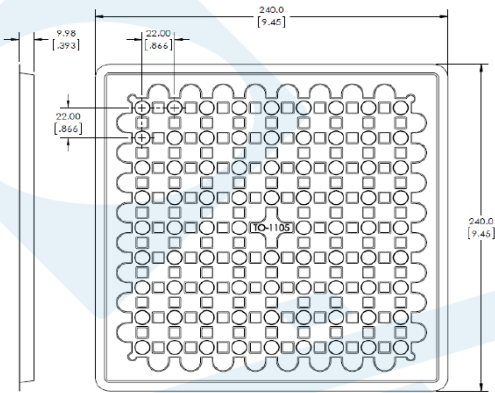

400 pcs per box
Each bag is boxed for easier storage/ stacking



Trays are sealed in an anti-static bag

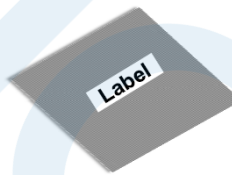

80 pcs per tray
5 trays are stacked together with separate cover

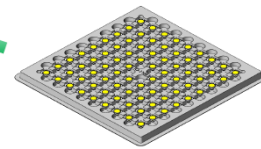

Shipping Container (CTM-14 and CTM-18)

Similar to above but 30 pcs per tray and 150 pcs per box

Shipping Container (CTM-22)

Similar to above but 20 pcs per tray and 100 pcs per box

Luminus Label Model:

	Luminus Devices Inc	RoHS Compliant
XXXXXX-XX-XX (Manufacturer Part Number & Bin Kits)	Rev XX	
<input type="text" value="Bar code"/>	<input type="text" value="Bar code"/>	
XXX-XX-XX-XX-XX-XXXX-XX-X (Customer Part Number)		
XXXXXXXXXXXXXXXXXX (Box ID)	Qty: XX	
<input type="text" value="Bar code"/>	<input type="text" value="Bar code"/>	

Handling Notes for Luminus COBs

Luminus products are designed for robust performance in general lighting applications; however, care must be taken when handling and assembling the LEDs into their fixtures. To avoid damaging Luminus COBs, please follow these guidelines. The following is an overview of the application notes detailing some of the practices to follow when working with these devices. More detailed information is available on the Luminus website at www.luminus.com

General Handling

Devices are made to be lifted or carried with tweezers on two “mouse bite” locations. At no time should the devices be handled by or should anything come in contact with the light emitting surface (LES) area. There are electrical connections under the LES which, if damaged, will cause the device to fail.

Static Electricity

LEDs are electronic devices which can be damaged by electrostatic discharge (ESD). Please use appropriate measures to assure the devices do not experience ESD during their handling and/or storage. ESD protection guidelines should be used at all times when working with LEDs.

Storage: Luminus products are delivered in ESD shielded bags and should be stored in these bags until used.

Assembly: Individuals handling LEDs during assembly should be trained in ESD protection practices. Assemblers should maintain constant conductive contact with a path to ground by means of a wrist strap, ankle straps, mat, or other ESD protection system.

Transporting: When transporting the devices from one assembly area to another, ESD shielded carts and carriers should be used.

Electrical Contact

Luminus COBs are designed with electrical contact pads on their top surface. These pads are clearly marked with “+” and “-” polarity. Wires can be soldered to the contact pads for electrical connections or other solderless connector products are available. If wires are being soldered to the COB product, we recommend attaching these wires prior to mounting the devices to a heat sink. Please contact Luminus for specific recommendations on how to solder wires if not familiar with the standard practice. Luminus can also offer design recommendations for jigs to enable easy soldering of multiple products in rapid succession.

Chemical Compatibility

The resin material used to form the emitters inside the LES can getter hydrocarbons from the surrounding environment. As a result, certain chemical compounds are not recommended for use with Luminus products. Use of these compounds can cause damage to the light output of the device and may permanently damage the device. Please refer to www.luminus.com for a list of the compounds not recommended for use with Luminus COB products.

Thermal Interface Material (TIM)

Proper thermal management is critical for successful operation of any LED system. Excess operating temperature can reduce the light output of the device, and excessive heating can cause permanent damage to the device. Proper TIM material is a crucial component for effective heat transfer away from the LED during normal operation. Please refer to www.luminus.com for specific recommendations for TIM solutions.

Human Eye Safety

Caution must be taken not to stare at the light emitted from Luminus LEDs, as severe eye damage may occur.