

Inductorless, Single Flash LED Driver with Programmable 1.5A Current Source

Features

- I²C interface programming and hardware STROBE control
- Single-channel programmable current source
 - ▶ Flash/Torch/IR modes
 - Flash: Up to 1.5A (128 levels)
 - Torch: Up to 376mA (128 levels)
 - ▶ Input low voltage protection function
 - ▶ Flash time-out protection
 - ▶ LED cathode ground connection for improved thermal dissipation
- LED open/short protection
- I²C fault readback
- RoHS and Green compliant
- Pb-free Packages: WLCSP-8
- -40°C to +85°C Temperature Range

Applications

- Smartphones and Tablets Camera Flash
- IR LED Driver
- Digital Cameras

Brief Description

KTD2691 is the ideal power solution for high-power flash LEDs. It includes one current source which can drive up to 1.5 A of LED flash current or up to 376 mA of torch current, and provides a very small total solution in portable applications. The device has both an I²C interface and a hardware STROBE pin for maximum control flexibility. The integrated current source on/off and current settings in Flash/Torch/IR modes can be programmed by the I²C interface. A selectable input low voltage protection function can prevent a system reset under low battery condition.

Various protection features are integrated into KTD2691 including LED fault (open or short) protection, flash timeout protection and thermal shutdown protection.

KTD2691 is available in a RoHS and Green 8-ball 1.519mm x 0.808mm x 0.500mm WLCSP package with 0.35mm pitch.

Typical Application

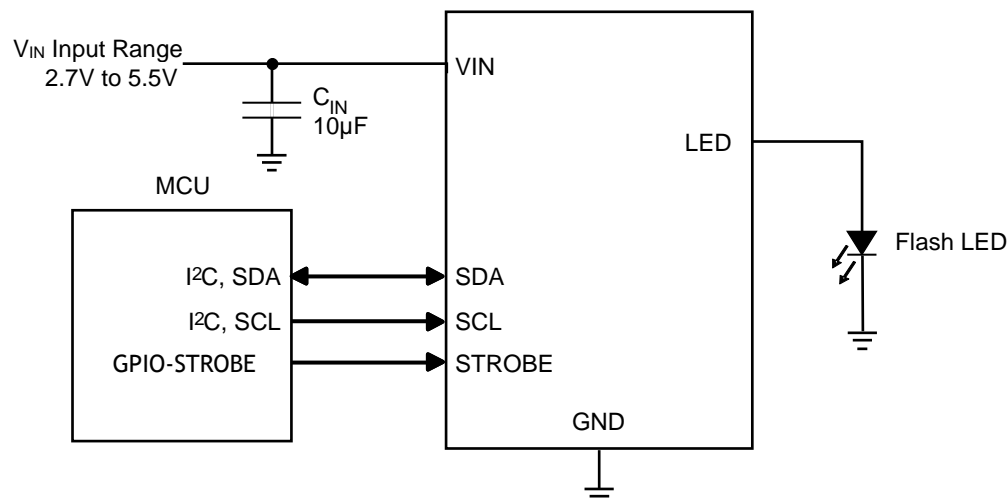

Pin Descriptions

Pin #	Name	Function
A1	GND	Ground pin
A2, C1	VIN	Input supply pin for the device. Connect a 10µF ceramic capacitor to GND.
B1	NC	No connect. Can be left floating or connected to VIN.
B2	STROBE	Active high FLASH/IR enable pin. There is an internal 300kΩ pull-down resistor at this pin to GND.
C2	SDA	Bi-direction data pin of the I ² C interface.
D1	LED	Regulated output current source.
D2	SCL	Clock input pin of the I ² C interface.

WLSCP-8

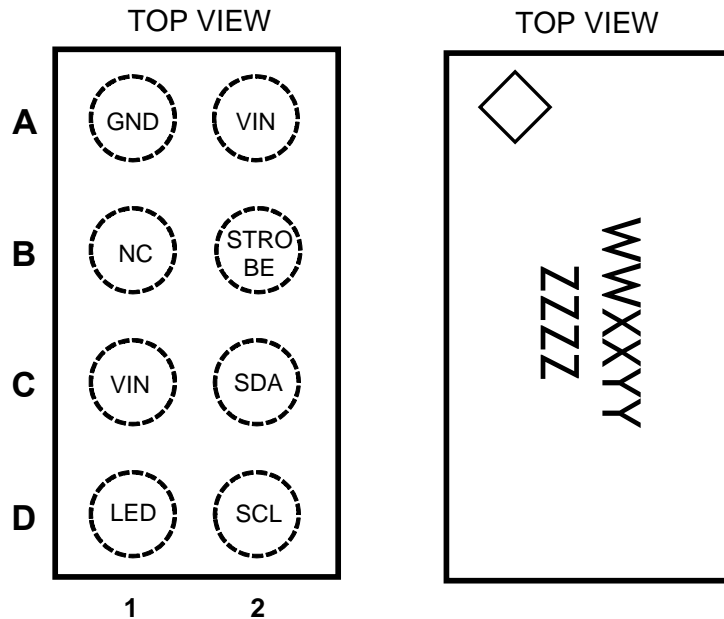

8-Bump 1.519mm x 0.808mm x 0.500mm WLCSP Package

Top Mark
 WW = Device ID Code, XX = Date Code
 YY = Assembly Code, ZZZZ = Serial Number

Absolute Maximum Ratings¹

(T_A = 25°C unless otherwise noted)

Symbol	Description	Value	Units
V _{IN}	Input voltage pins	-0.3 to 6	V
LED	Current source pin	-0.3 to V _{IN} +0.3	V
SCL, SDA, STROBE	Control pins	-0.3 to V _{IN} +0.3	V
T _J	Operating Temperature Range	-40 to 150	°C
T _S	Storage Temperature Range	-65 to 150	°C
T _{LEAD}	Maximum Soldering Temperature (at leads, 10 sec)	300	°C
ESD	HBM electrical static discharge	2.0	kV

Thermal Capabilities

Symbol	Description	Value	Units
θ _{JA}	Thermal Resistance – Junction to Ambient ²	125	°C/W
P _D	Maximum Power Dissipation at T _A ≤ 25°C	1.0 ³	W
ΔP _D /ΔT	Derating Factor Above T _A = 25°C	-8.0	mW/°C

Recommended Operating Range

Description	Value
V _{IN} , LED	2.7V to 5.5V

Ordering Information

Part Number	Marking ⁴	Operating Temperature	Package
KTD2691ERAA-TA	RHXXYYZZZZ	-40°C to +85°C	WLCSP-8

- Stresses above those listed in Absolute Maximum Ratings may cause permanent damage to the device. Functional operation at conditions other than the operating conditions specified is not implied. Only one Absolute Maximum rating should be applied at any one time.
- Junction to Ambient thermal resistance is highly dependent on PCB layout. Values are based on thermal properties of the device when soldered to an EV board.
- Internal shutdown circuitry protects the device from permanent damage. Thermal shutdown activated at typically T_J = 150°C and re-engages at typically 130°C.
- RH = Device ID Code, XX = Date Code, YY = Assembly Code, ZZZZ = Serial Number.

Electrical Characteristics⁵

Unless otherwise noted, the *Min* and *Max* specs are applied over the full operation temperature range of -40°C to +85°C, while *Typ* values are specified at room temperature (25°C), $V_{IN} = 3.6V$.

Symbol	Description	Conditions	Min	Typ	Max	Units	
VIN Supply							
V_{IN}	Input operating range		2.7		5.5	V	
I_Q	IC operating current			0.6		mA	
I_{SB}	V_{IN} pin standby current	Device disabled, I ² C is Standby		0.5	2	μA	
UVLO	Input under voltage lockout	VIN Rising		2.4		V	
UVLO _{HYST}	UVLO hysteresis			0.10		V	
Current Source							
I_D	Output Current Accuracy, Flash Mode	LED = 1500mA setting	$T_A = 25^\circ C$	-5%	1500	+5%	mA
	Output Current Accuracy, Torch Mode	LED = 376mA setting		-9%	376	+9%	mA
V_{HR}	LED Current Source Headroom	LED = 1500mA setting	Flash Mode		500		mV
		LED = 1000mA setting	Flash Mode		490		mV
		LED = 376mA setting	Torch Mode		300		mV
$T_{TIMEOUT}$	Flash Timeout Period	Reg 0x02, bit[4:1] = '1100'		1000		ms	
V_{LVP}	V_{IN} low voltage protection threshold	Reg 0x02, bit[7:5] = '000', $T_A = 25^\circ C$		2.9		V	
I²C-Compatible Voltage Specifications (SCL, SDA)							
V_{IL}	Input Logic Low Threshold				0.4	V	
V_{IH}	Input Logic High Threshold		1.4			V	
V_{OL}	SDA Output Logic Low	$I_{SDA} = 3mA$			0.4	V	
I²C-Compatible Timing Specifications (SCL, SDA), see Figure 1							
t_1	SCL (Clock Period)		2.5			μs	
t_2	Data In Setup Time to SCL High		100			ns	
t_3	Data Out Stable After SCL Low		0			ns	
t_4	SDA Low Setup Time to SCL, Low (Start)		100			ns	
t_5	SDA High Setup Time to after SCL, High (Stop)		100			ns	
Control – STROBE							
V_{TH-L}	Input Logic Low Threshold				0.4	V	
V_{TH-H}	Input Logic High Threshold		1.4			V	
$R_{PULL-down}$	Internal pull-down resistor			300		kΩ	
Thermal Shutdown							
T_{J-TH}	Thermal shutdown threshold			150		°C	
	Thermal shutdown hysteresis			20		°C	

5. KTD2691 is guaranteed to meet performance specifications over the -40°C to +85°C operating temperature range by design, characterization and correlation with statistical process controls.

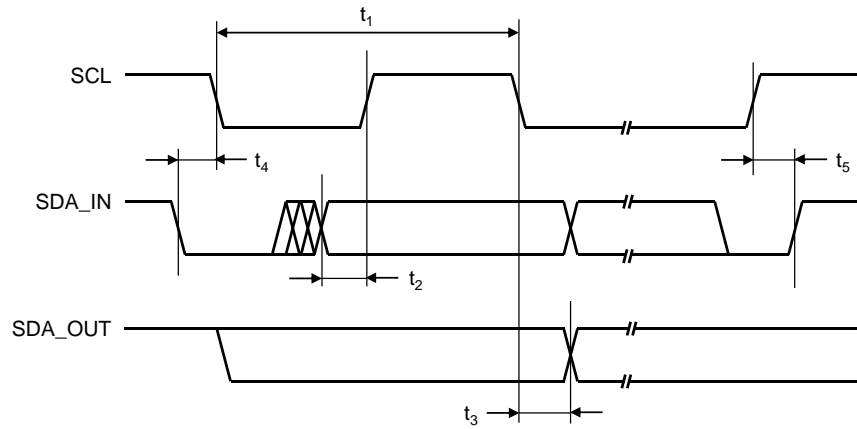
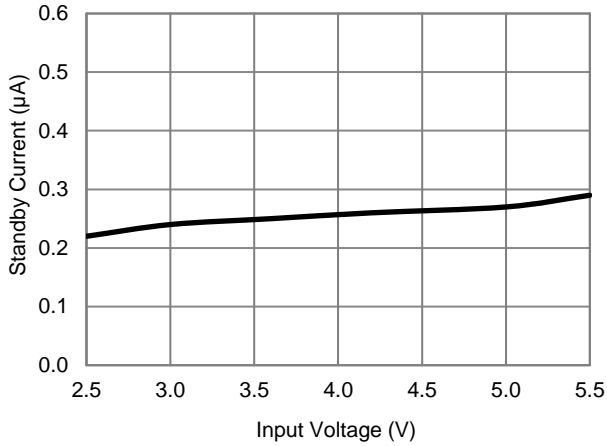

Figure 1. I²C Compatible Interface Timing

Typical Characteristics

$V_{IN} = 3.6V$, $C_{IN} = 10\mu F$, Temp = 25°C unless otherwise specified.

Input Standby Current vs VIN



Input Quiescent Current vs VIN

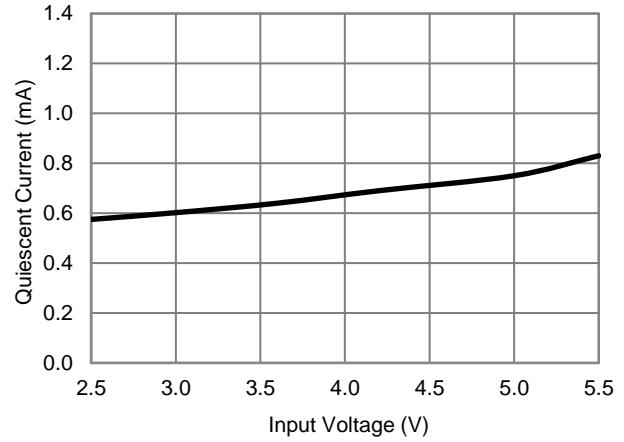

LED Torch Current vs Code

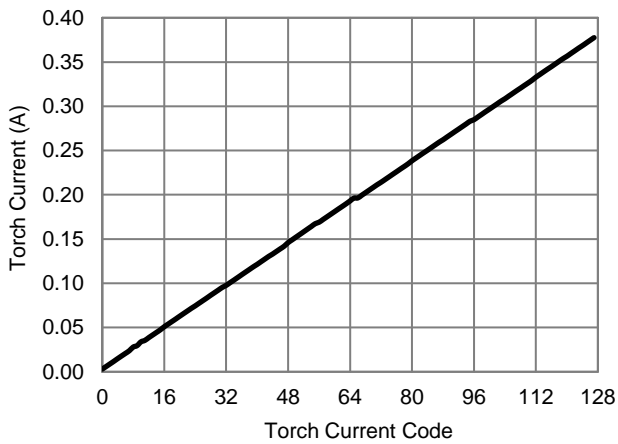

Note: the maximum code value is 127 (7-bit).

LED Flash Current vs Code

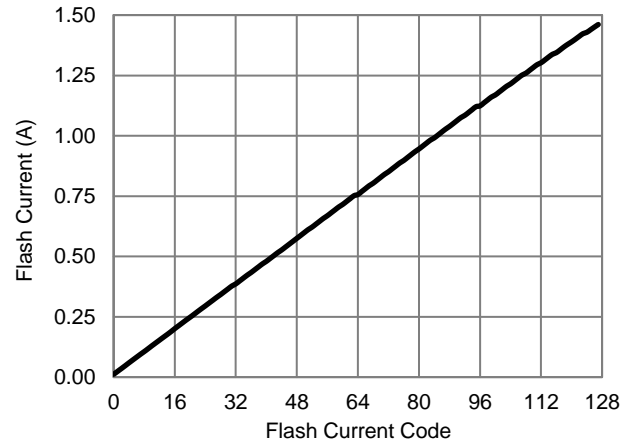

Note: the maximum code value is 127 (7-bit).

Typical Characteristics

$V_{IN} = 3.6V$, $C_{IN} = 10\mu F$, Temp = 25°C unless otherwise specified.

LED Torch Current VS Input Voltage

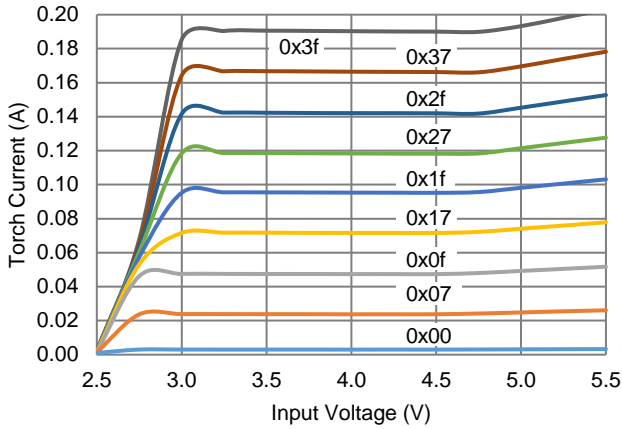

LED Torch Current VS Input Voltage

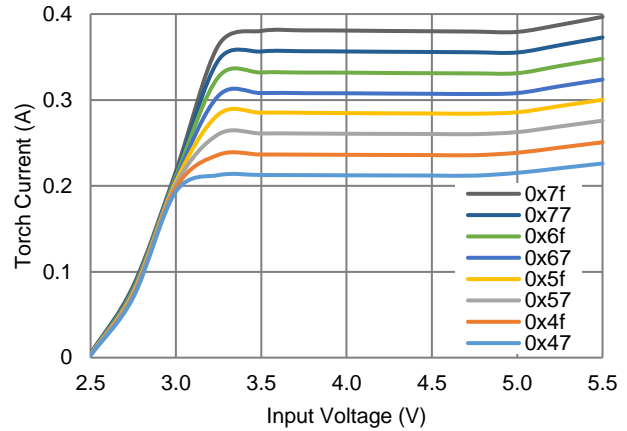

LED Flash Current VS Input Voltage

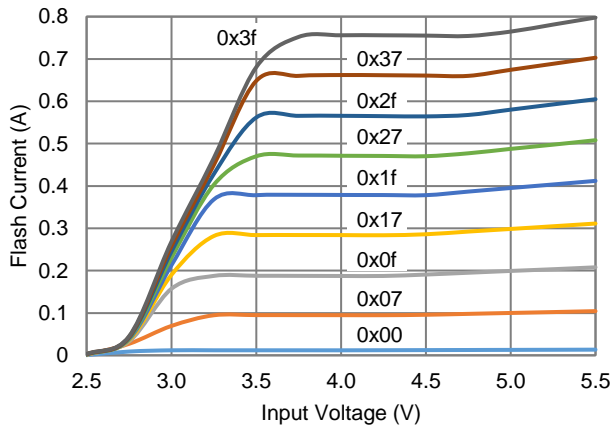

LED Flash Current VS Input Voltage

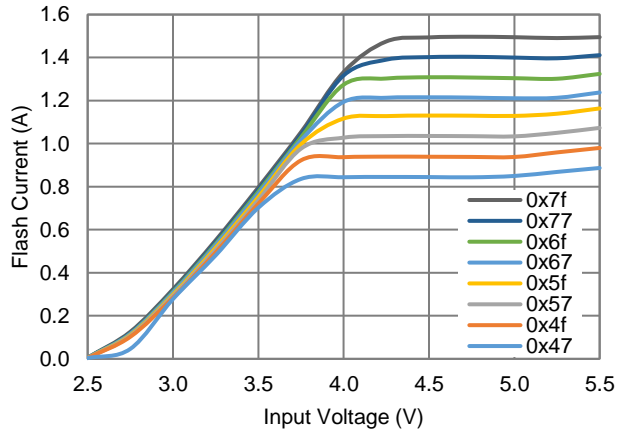

Typical Characteristics

$V_{IN} = 3.6V$, $C_{IN} = 10\mu F$, Temp = 25°C unless otherwise specified.

Flash Turn ON By I2C

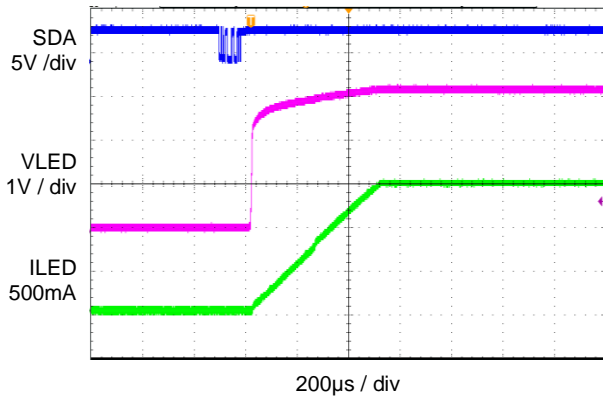

Flash Time-Out (40ms setting)

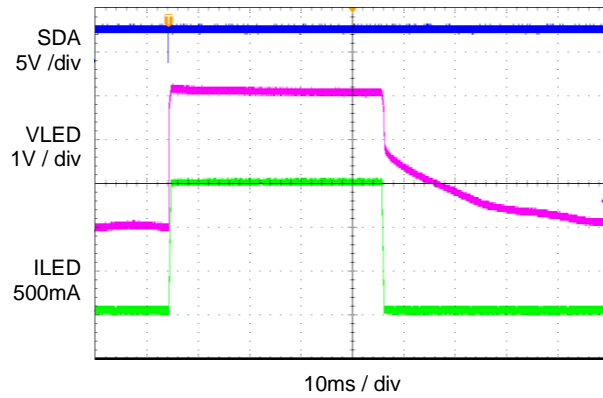

Torch ON By I2C

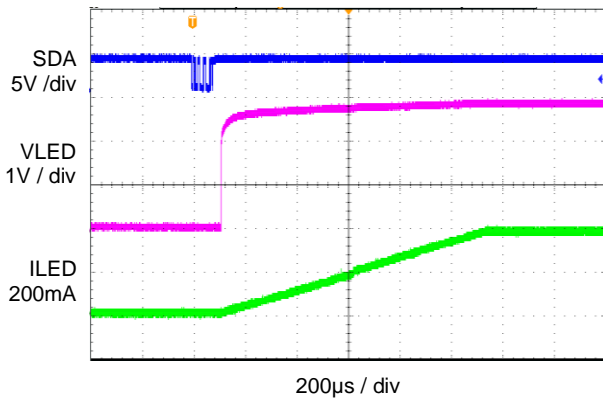

Torch Off By I2C

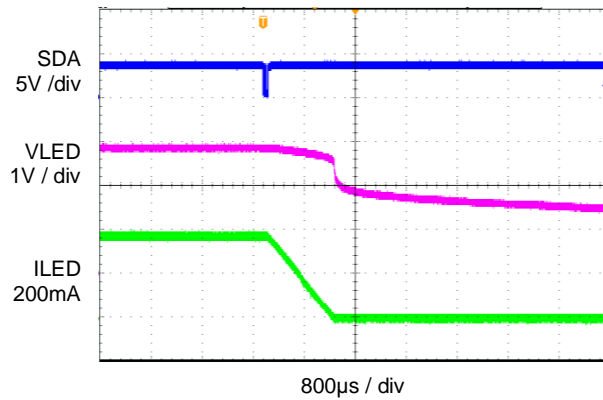

Strobe Turn On

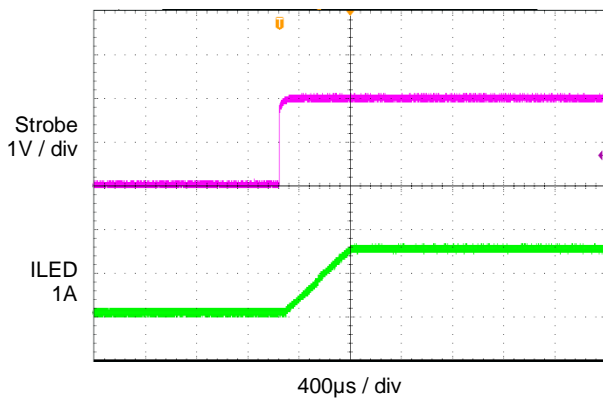

Strobe Turn Off

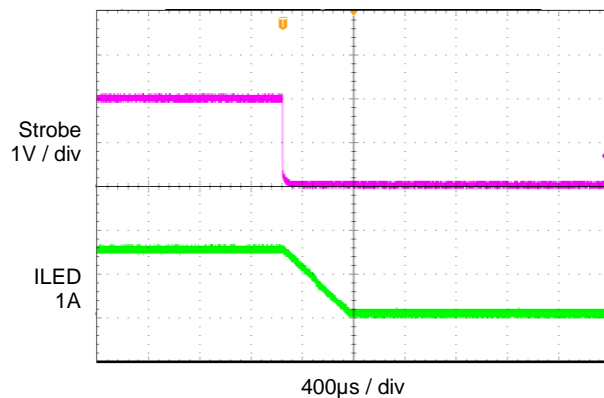

Typical Characteristics

$V_{IN} = 3.6V$, $C_{IN} = 10\mu F$, Temp = 25°C unless otherwise specified.

Strobe Edge Triggered (40ms Time-out)

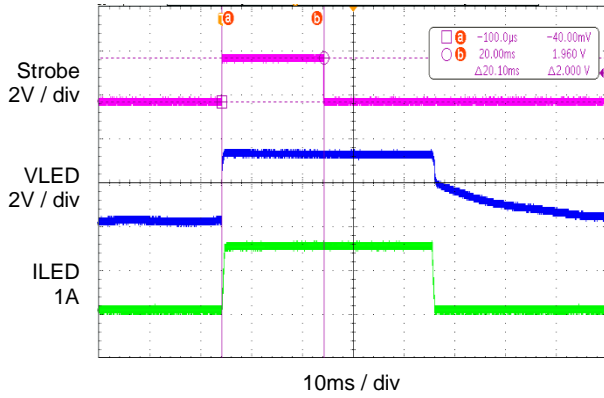

Strobe Level Triggered

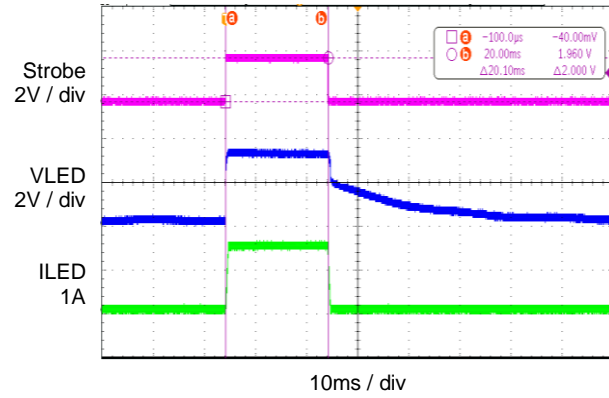

Strobe ON to Flash Time-Out (40ms Time-out setting)

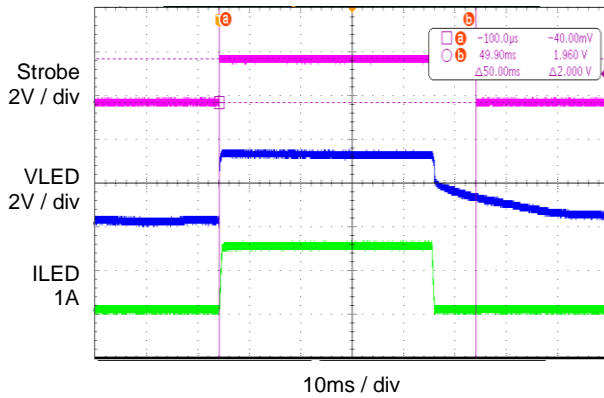

IR Mode

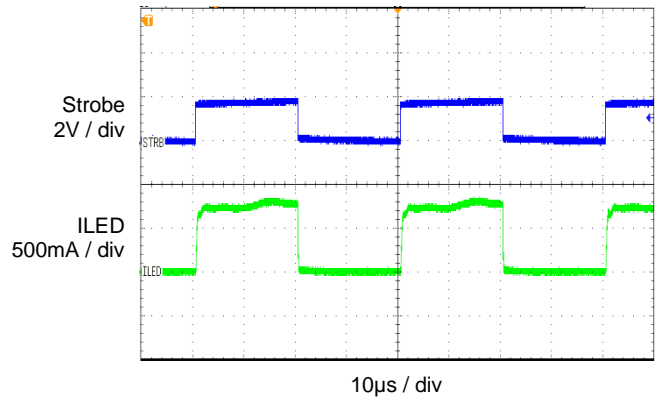

Functional Block Diagram

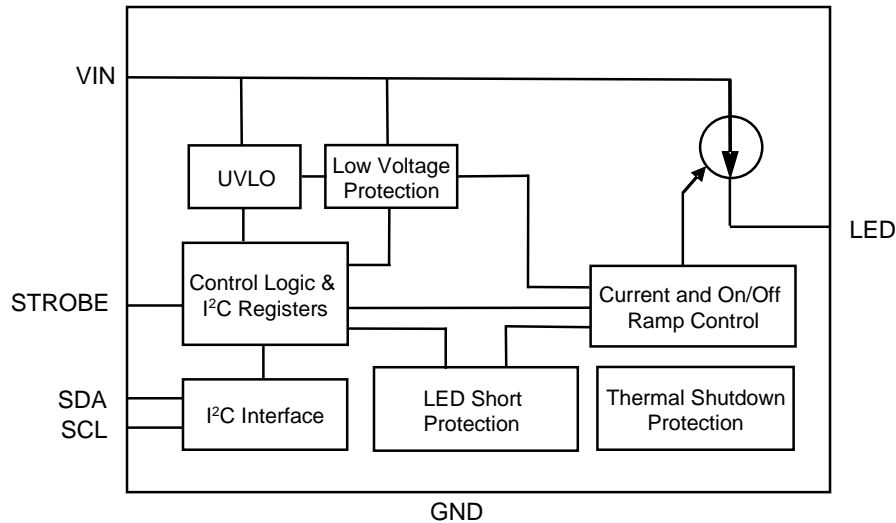

Functional Description

KTD2691 is a high-power flash LED driver capable of delivering up to 1.5A of LED current. It consists of a programmable high current source which can produce up to 1.5 A of LED flash current or up to 376 mA of torch current in a small WLCSP package size.

The control interface is designed for maximum flexibility and compatibility with various types of system controls. KTD2691 is mainly programmed and controlled via an I²C-compatible interface, but also includes logic input that can provide a hardware flash enable (STROBE). The I²C control features include the current control of the current source in Flash/Torch/IR modes, flash safety time-out protection and various fault events read back. In addition, KTD2691 also has various protection features including LED open and short protection.

Flash Mode

In Flash mode, LED current can be programmed up to 1.5A. The flash current values are controlled by I²C register 0x03. The flash mode can be activated either by I²C register 0x01 bits[1:0] or by STROBE pin rising edge when STROBE pin is enabled, and it can be deactivated by I²C register 0x01 bits[1:0], or by STROBE pin, or by flash time-out event. After the flash time-out event, I²C register 0x01 bits[1:0] will be reset to standby mode.

If using STROBE pin to control the flash mode, there is an option to select when the flash mode is deactivated. If Strobe Type is selected as Level Triggered, flash mode is deactivated during STROBE pin falling edge or flash time-out event, as shown in Figure 2. If Strobe Type is selected as Edge Triggered, flash mode is only deactivated during flash time-out event, STROBE pin falling edge cannot deactivate it, as shown in Figure 3.

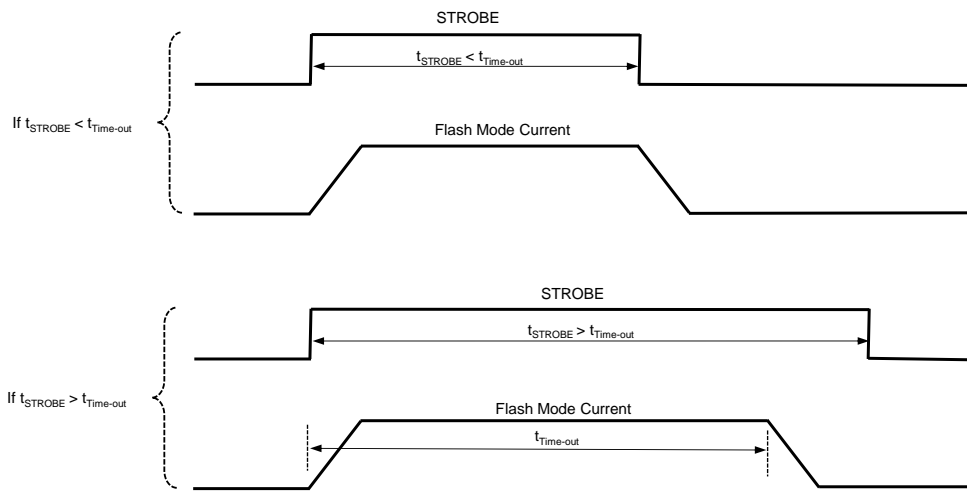

Figure 2. Flash Mode Current Controlled by STROBE (Level Triggered)

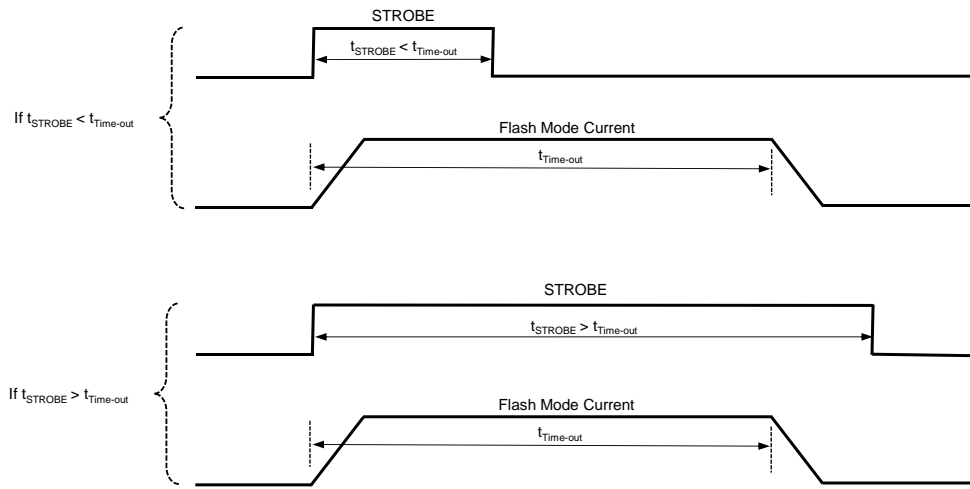

Figure 3. Flash Mode Current Controlled by STROBE (Edge Triggered)

Torch Mode

In Torch mode, LED current can be programmed up to 376mA. The torch current value is controlled by I²C register 0x04. The torch on/off ramp time is controlled by I²C register 0x02 bit [0].

IR Mode

In IR mode, the current setting is similar to Flash mode setting, which is controlled by I²C register 0x03. For IR mode, I²C register 0x01 bits[1:0] should be '01' and STROBE pin should be enabled, then STROBE pin rising edge can activate IR mode, and STROBE pin falling edge or flash time-out event can deactivate IR mode. In IR mode, the current source is enabled to the full current setting with no delay or slow ramp during STROBE rising edge, and it is fully turned off immediately with no delay or slow ramp during STROBE falling edge. This allows IR current to follow the fast frequency IR transmission of the STROBE pin signal. For IR mode, STROBE pin only allows Level Triggered, and doesn't allow Edge Triggered, but it is still protected by flash time-out if STROBE width is too long.

Table 1 summarizes the control of Shutdown/Standby/Flash/Torch/IR modes.

Table 1. Mode Control Table

I ² C register 0x01 bits[1:0]	STROBE Enable(0x01 bit[2])	STROBE Pin	FUNCTION
00	0	X	Standby
00	1	Positive Edge	External Flash Mode
10	X	X	Internal Torch Mode
11	X	X	Internal Flash Mode
01	0	X	IR Standby Mode
01	1	0	IR Standby Mode
01	1	Positive Edge	IR Mode

VIN Low Voltage Protection (LVP)

In flash mode, the high LED current might pull the input battery voltage low. KTD2691 has VIN Low Voltage Protection (LVP) function to adjust the LED current based on the input voltage to prevent the battery voltage from going too low and trigger a system reset. The adjustable LVP threshold has 8 steps, ranging from 2.9V to 3.6V with 0.1V step. During the flash current turn on ramp, if VIN drops below the LVP threshold, after 4μs deglitch delay, the LED current stops rising and remains at the last value. After that, even if VIN changes, the LED current setting will not change during the remaining of the flash event. The LVP function only work in flash mode.

LVP event writes a '1' into the I²C register 0x05 bit[6], this fault flag bit resets to '0' once the register is read via I²C interface, or by VIN power on reset, or by I²C software reset.

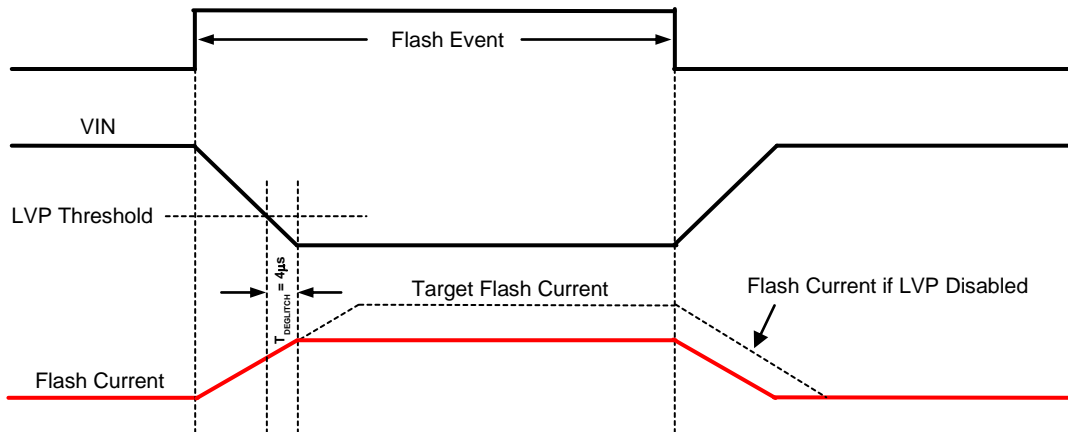

Figure 4. LVP Function

Flash Time-out

The Flash time-out function sets the maximum time of one flash event, whether a flash stop command is received or not. The device has 16 flash time-out settings controlled by I²C register 0x02 bits [4:1], ranging from 40ms to 1600ms. Flash time-out feature applies to both flash and IR modes. Flash time-out event writes a '1' to the I²C register 0x05 bit[0], this fault flag is reset to '0' when it is read through I²C interface, or by VIN power on reset, or by I²C software reset.

UVLO

The device has under voltage lock-out (UVLO) function to monitor the input voltage. Once the input voltage VIN drops below UVLO falling threshold (around 2.35V), the output current is disabled. Once the input voltage increases above UVLO rising threshold (around 2.5V), the output current resumes its previous setting. UVLO

event writes a '1' to the I²C register 0x05 bit[1], this fault flag is reset to '0' once I²C register 0x0A is read through I²C interface, or by VIN power on reset, or by I²C software reset. Even it is not read back, the device resumes normal operation once the input voltage comes back above UVLO rising threshold.

Thermal Shutdown

In flash or IR mode, the device has thermal shutdown protection, when the IC temperature goes above thermal shutdown rising threshold (around 150°C), the output current is disabled. Once the IC temperature drops below thermal shutdown falling threshold (around 130°C), the output current resumes to its previous setting. Thermal shutdown writes a '1' to the I²C register 0x05 bit[2], this fault flag is reset to '0' once I²C register 0x0A is read back through I²C interface, or by VIN power-on-reset, or by I²C software reset. Even if the register is not read back, the device resumes normal operation once the IC temperature goes below thermal shutdown falling threshold.

LED Short Protection

After turn-on ramp of the output current, the device senses the LED pin voltage. If the LED pin voltage drops below around 0.5V, after about 256µs deglitch time, the LED channel is disabled. LED short condition writes a '1' to the I²C register 0x05 bit[5], this fault flag is reset to '0' once I²C register 0x05 is read back, or by VIN power-on-reset, or by I²C software reset.

Once the LED short condition is removed, the device can resume normal operation by following the sequence below.

- 1) Select Standby mode by writing to Reg 0x01 [1:0] = 00,
- 2) Select the mode, IR or Torch or Flash, by writing to Reg 0x01[1:0] = 01 or 10 or 11 respectively.

It is not required to read Reg 0x05 to clear the LED fault flag.

LED Open Protection

If KTD2691 is enabled while an LED pin is open during normal operation, the device senses the LED pin voltage to automatically detect whether the LED channel is open and then disables the open channel.

Once the LED open condition is removed, the driver can resume normal operation by following the sequence below.

- 1) Select Standby mode by writing to Reg 0x01 [1:0] = 00,
- 2) Select the mode, IR or Torch or Flash, by writing to Reg 0x01[1:0] = 01 or 10 or 11 respectively.

Software Reset

The device has a software reset function controlled by I²C register 0x06 bit[7]. Writing a '1' to this bit resets all I²C registers to their default settings and reset all fault flags; this bit will also be reset to '0' automatically.

Application Information

I²C Serial Data Bus

KTD2691 supports the I²C bus protocol. A device that sends data onto the bus is defined as a transmitter and a device receiving data as a receiver. The device that controls the bus is called a master, whereas the devices controlled by the master are known as slaves. A master device must generate the serial clock (SCL), control bus access and generate START and STOP conditions to control the bus. KTD2691 operates as a slave on the I²C bus. Within the bus specifications a standard mode (100kHz maximum clock rate) and a fast mode (400kHz maximum clock rate) are defined. KTD2691 works in both modes. Connections to the bus are made through the open-drain I/O lines SDA and SCL.

The following bus protocol has been defined in Figure 5:

- Data transfer may be initiated only when the bus is not busy.
- During data transfer, the data line must remain stable whenever the clock line is HIGH. Changes in the data line while the clock line is high are interpreted as control signals.

Accordingly, the following bus conditions have been defined:

Bus Not Busy

Both data and clock lines remain HIGH.

Start Data Transfer

A change in the state of the data line, from HIGH to LOW, while the clock is HIGH, defines a START condition.

Stop Data Transfer

A change in the state of the data line, from LOW to HIGH, while the clock line is HIGH, defines the STOP condition.

Data Valid

The state of the data line represents valid data when, after a START condition, the data line is stable for the duration of the HIGH period of the clock signal. The data on the line must be changed during the LOW period of the clock signal. There is one clock pulse per bit of data.

Each data transfer is initiated with a START condition and terminated with a STOP condition. The number of data bytes transferred between START and STOP conditions are not limited, and are determined by the master device. The information is transferred byte-wise and each receiver acknowledges with a ninth bit.

Acknowledge

Each receiving device, when addressed, is obliged to generate an acknowledge after the reception of each byte. The master device must generate an extra clock pulse that is associated with this acknowledge bit.

A device that acknowledges must pull down the SDA line during the acknowledge clock pulse in such a way that the SDA line is stable LOW during the HIGH period of the acknowledge-related clock pulse. Setup and hold times must also be taken into account.

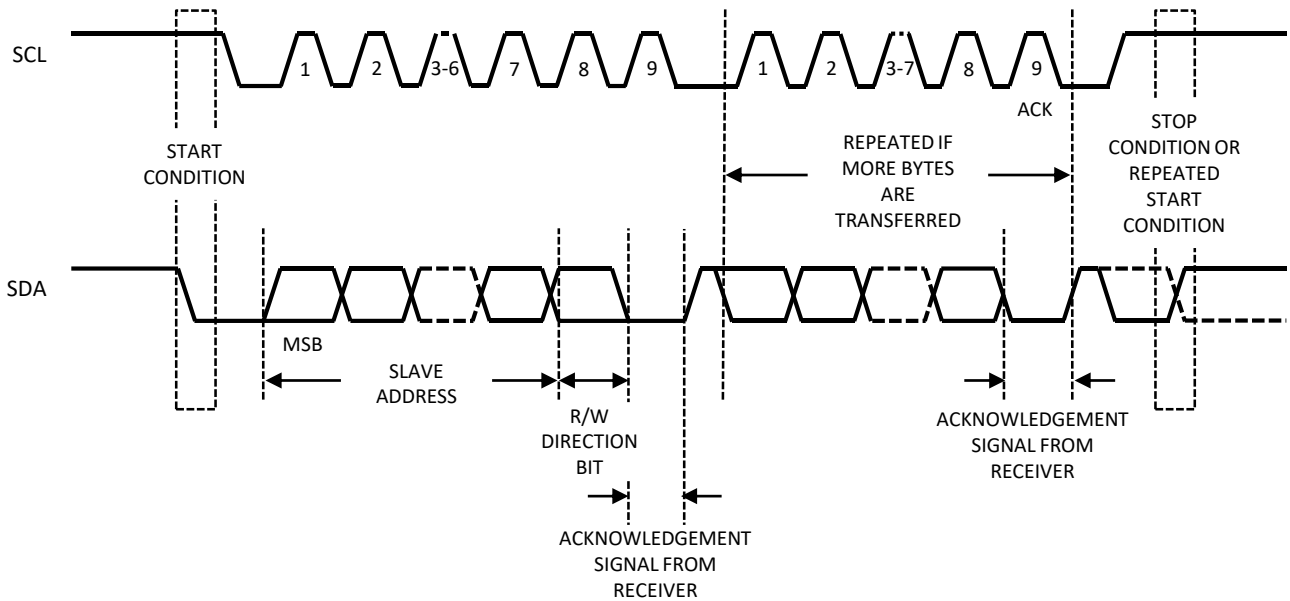

Figure 5. Data Transfer on I²C Serial Bus

KTD2691 7-bit slave device address is 1100100 binary (or 0x64h).

There are two kinds of I²C data transfer cycles: write cycle and read cycle.

I²C Write Cycle

For I²C write cycle, data is transferred from a master to a slave. The first byte transmitted is the 7-bit slave address plus one bit of '0' for write. Next follows a number of data bytes. The slave returns an acknowledge bit after each received byte. Data is transferred with the most significant bit (MSB) first. Figure 6 shows the sequence of the I²C write cycle.

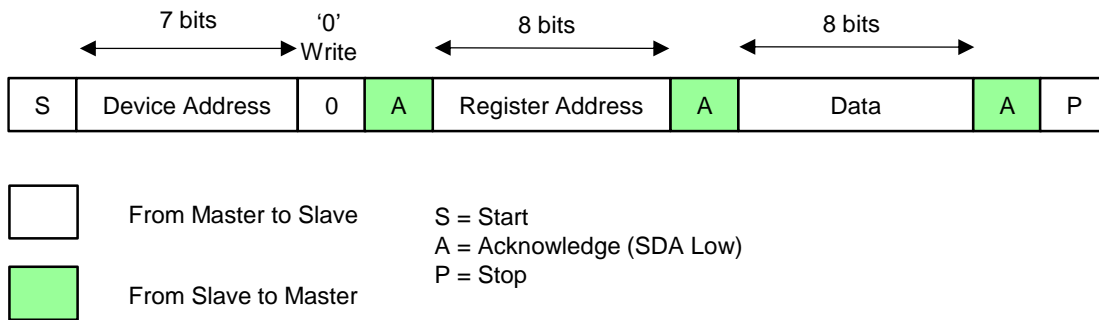

Figure 6. I²C Write Cycle

I²C Write Cycle Steps:

- Master generates start condition.
- Master sends 7-bit slave address and 1-bit data direction '0' for write.
- Slave sends acknowledge if the slave address is matched.
- Master sends 8-bit register address.
- Slave sends acknowledge.
- Master sends 8-bit data for that addressed register.
- Slave sends acknowledge.
- If master sends more data bytes, the register address will be incremented by one after each acknowledge.
- Master generates stop condition to finish the write cycle.

I²C Read Cycle

For I²C read cycle, data is transferred from a slave to a master. But to start the read cycle, master needs to write the register address first to define which register data to read. Figure 7 shows the steps of the I²C read cycle.

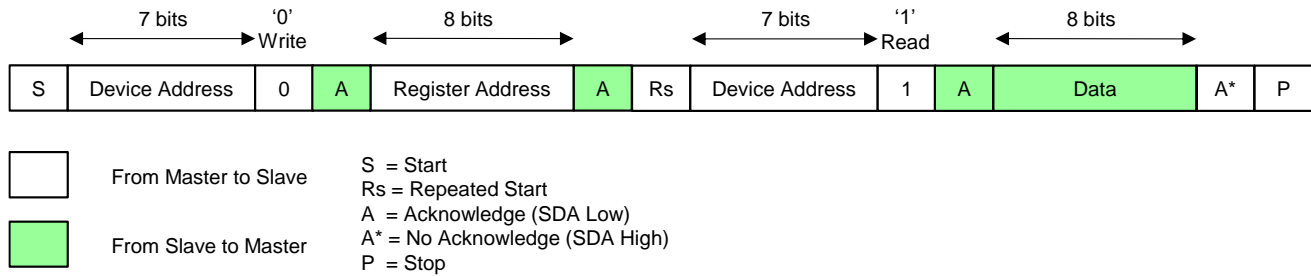

Figure 7. I²C Read Cycle

I²C Read Cycle Steps:

- Master generates start condition.
- Master sends 7-bit slave address and 1-bit data direction '0' for write.
- Slave sends acknowledge if the slave address is matched.
- Master sends 8-bit register address.
- Slave sends acknowledge.
- Master generates repeated start condition.
- Master sends 7-bit slave address and 1-bit data direction '1' for read.
- Slave sends acknowledge if the slave address is matched.
- Slave sends the data byte of that addressed register.
- If master sends acknowledge, the register address will be incremented by one after each acknowledge and the slave will continue to send the data for the updated addressed register.
- If master sends no acknowledge, the slave will stop sending the data.
- Master generates stop condition to finish the read cycle.

I²C Register Map

Table 2 summarizes the device I²C registers, their read/write access and default values. The I²C registers can be reset to their default values by VIN power-on-reset, or by I²C software reset.

Table 2. I²C Register Map

Register Name	Address (Hex)	Read/Write	Default Value
Enable Register	0x01	Read/Write	0x20
Configuration Register	0x02	Read/Write	0x19
LED Flash Current Register	0x03	Read/Write	0x00
LED Torch Current Register	0x04	Read/Write	0x00
Fault Flag Register	0x05	Read	0x00
Device ID Register	0x06	Read/Write	Reserved

I²C Register Description

The following tables summarize the setting of each I²C register. Reserved bits should be written as '0' and ignored during read.

Table 3. Enable Register (Address 0x01, Read/Write)

Bit 7	Bit 6	Bit 5	Bit 4 LVP Enable	Bit 3 STROBE Pin Trigger	Bit 2 STROBE Pin	Bits [1:0] Mode Setting
RSVD	RSVD	RSVD	0 = Disable (Default) 1 = Enable	0 = Level (Default) 1 = Edge	0 = Disable (Default) 1 = Enable	00 = Standby (Default) 01 = IR Mode 10 = Torch Mode 11 = Flash Mode

Note: Adjusting STROBE Level/Edge trigger setting while turning on/off flash mode using STROBE pin is not recommended. There is no timing limit for STROBE pulse width to turn on/off the flash mode.

Table 4. Configuration Register (Address 0x02, Read/Write)

Bits [7:5] LVP Voltage Threshold	Bits [4:1] Flash Time-out Duration	Bit [0] Torch Ramp Time
000 = 2.9V (Default) 001 = 3.0V 010 = 3.1V 011 = 3.2V 100 = 3.3V 101 = 3.4V 110 = 3.5V 111 = 3.6V	0000 = 40ms 0001 = 80ms 0010 = 120ms 0011 = 160ms 0100 = 200ms 0101 = 240ms 0110 = 280ms 0111 = 320ms 1000 = 360ms 1001 = 400ms 1010 = 600ms 1011 = 800ms 1100 = 1000ms (Default) 1101 = 1200ms 1110 = 1400ms 1111 = 1600ms	0 = No Ramp 1 = 1ms (default)

Table 5. LED Flash Current Register (Address 0x03, Read/Write)

Bit [7]	Bits [6:0] LED Flash Current Code
RSVD	$I_{FLASH} (mA) = (Code + 1) \times 1500 / 128 (mA)$ 0000000 = 11.72mA (Default) 0000001 = 23.44mA 0111111 = 750mA 1000000 = 761.72mA 1111111 = 1500mA

Table 6. LED Torch Current Register (Address 0x04, Read/Write)

Bit 7	Bits [6:0] LED Torch Current Code
RSVD	$I_{TORCH} (mA) = (Code + 1) \times 376mA / 128$ 0000000 = 2.94mA (Default) 0000001 = 5.88mA 0111111 = 188mA 1000000 = 190.94mA 1111111 = 376mA

Table 7. Fault Flag Register (Address 0x05, Read Only)

Bit 7 OVP	Bit 6 LVP	Bit 5 LED Short	Bit 4 Current Limit	Bit 3	Bit 2 Thermal Shutdown (TSD)	Bit 1 UVLO	Bit 0 Flash Time-Out
RSVD	0 = Normal 1 = LVP	0 = Normal 1 = LED Short	RSVD	RSVD	0 = Normal 1 = Thermal Shutdown	0 = Normal 1 = UVLO	0 = Normal 1 = Flash Time-out

Table 8. Device ID Register (Address 0x06, Read and Write bit 7 = 1 to Reset)

Bit 7 Software Reset	Bit 6	Bits [5:3] Device ID	Bits [2:0] Revision
0 = Don't Reset (Default) 1 = Reset	RSVD	001	Reserved

Capacitor Selection

For good voltage filtering, low ESR ceramic capacitors are recommended. A 10- μ F input capacitor is recommended for high current flash LEDs to improve transient behavior of the IC. The input capacitor should be placed as close as possible to the VIN pin and the GND pin.

Table 9. Recommended Ceramic Capacitor Vendors

Manufacturer	Website
Murata	www.murata.com
AVX	www.avx.com
Taiyo Yuden	www.t-yuden.com

PC Board Layout

The input bypass capacitors should be placed as close to the IC as possible. The capacitor ground should be placed close to the IC GND pin.

Packaging Information

WLCSP24-8 (0.808mm x 1.519mm x 0.500mm)

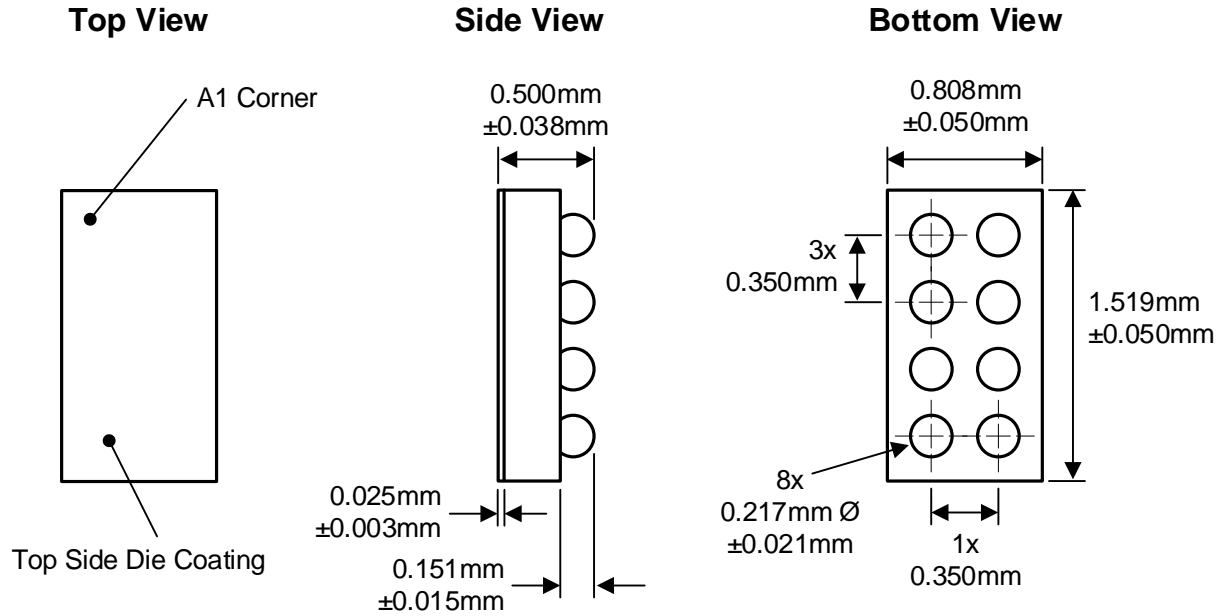

Recommended Footprint

(NSMD Pad Type)

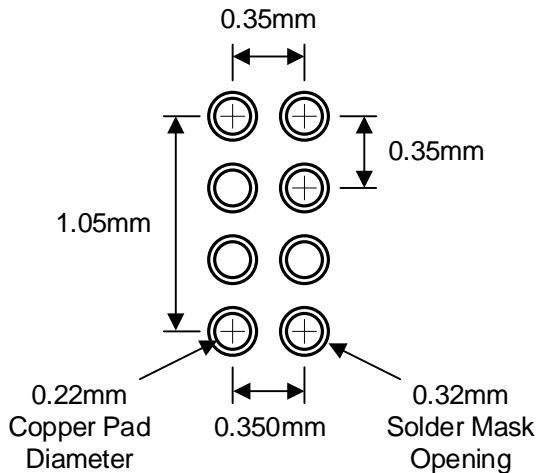

Singel 3 | B-2550 Kontich | Belgium | Tel. +32 (0)3 458 30 33
 info@alcom.be | www.alcom.be
 Rivium 1e straat 52 | 2909 LE Capelle aan den IJssel | The Netherlands
 Tel. +31 (0)10 288 25 00 | info@alcom.nl | www.alcom.nl

Kinetic Technologies cannot assume responsibility for use of any circuitry other than circuitry entirely embodied in a Kinetic Technologies product. No intellectual property or circuit patent licenses are implied. Kinetic Technologies reserves the right to change the circuitry and specifications without notice at any time.