

## 9-Channel IR LED Driver with Buck Regulator and I<sup>2</sup>C Interface

### Features

- 2.7V to 5.5V Input Voltage Operating Range
  - Nine High-Precision Current Sinks
    - ▶ LED Current Up to 32mA per Channel
    - ▶  $\pm 1\%$  Typical Current Matching
    - ▶  $\pm 2\%$  Typical Current Accuracy at 32mA
    - ▶ 6-bit Current Dimming Control with I<sup>2</sup>C
    - ▶ Independent On/Off Control
    - ▶ Supports both Independent and Global Dimming
  - High Efficiency Buck Regulator
    - ▶ Integrated 200m $\Omega$  / 100m $\Omega$  High / Low-Side FET
    - ▶ Adaptive On-Time Control with default 1MHz Switching Frequency, with factory programmable 1.5MHz, 2MHz, and 2.5MHz options.
    - ▶ Adaptive VOUT Control Based on the Headroom Voltages of the LED Current Sinks.
    - ▶ Selectable Auto-Skip Mode or Forced-PWM mode at Light Loads
  - 140 $\mu$ A Typical No-Load Supply Current
  - Open-Drain  $\overline{\text{FAULT}}$  Signal Output and Fault Reset
  - Extensive Fault Diagnostics
  - -40°C - 85°C Operating Ambient Temperature Range
- Small UQFN-20 (3mm x 3mm) Package

### Applications

- IR LED Drivers
- Video Door Bells
- Security Cameras
- IRIS Recognition Cameras

### Typical Application

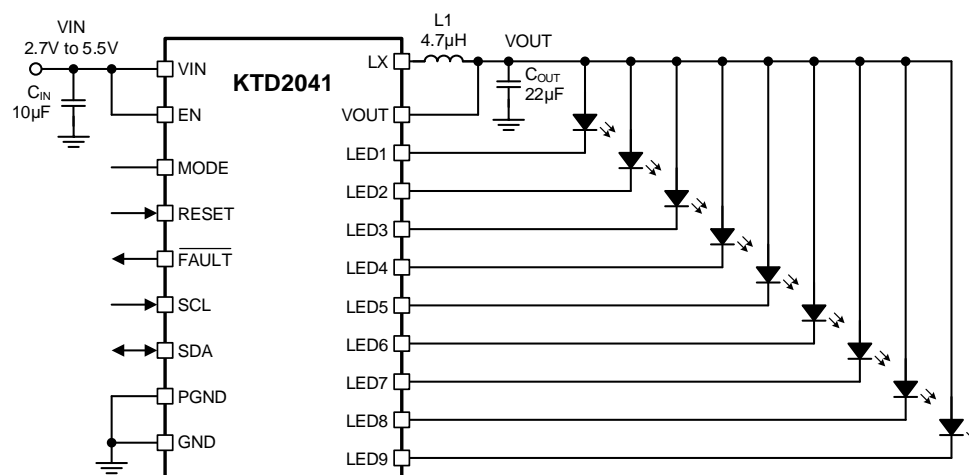

### Brief Description

The KTD2041 is an ideal power solution for IR LED driver with an integrated buck regulator. It has 9 high-precision current sinks that can be independently controlled via I<sup>2</sup>C interface.

The buck regulator has an input voltage operating range from 2.7V to 5.5V to accommodate 1-cell lithium-ion batteries or 5V voltage rail. It has adaptive output voltage control based on the headroom voltages of the LED current sinks to minimize the power consumption. It has integrated high-side and low-side power FET. The buck regulator features advanced adaptive On-Time control with 1MHz switching frequency, which minimizes external component counts and allows the use of a very small inductor and capacitor.

The KTD2041 has 9 built-in current sinks, which features independent On/Off control and 6-bit independent current dimming via I<sup>2</sup>C interface. The KTD2041 has extensive built-in protection features including cycle-by-cycle current limit, input undervoltage Lockout (UVLO), output over-voltage protection, LED fault (open or short) protection and thermal shutdown protection.

The KTD2041 is available in a RoHS and Green compliant 3mm x 3mm UQFN package.

## Pin Descriptions

Pin #	Name	Function
1	MODE	Mode selection logic input pin. Low for Forced-PWM mode, High for Auto-Skip mode at light loads.
2	SDA	I <sup>2</sup> C Serial Interface Data.
3	SCL	I <sup>2</sup> C Serial Interface Clock.
4	FAULT	Fault signal open-drain output. Logic low output indicates fault conditions, logic high indicates no fault.
5	RESET	Fault Reset pin, connected to GND if not used.
6	LED9	LED9 current sink.
7	LED8	LED8 current sink.
8	LED7	LED7 current sink.
9	LED6	LED6 current sink.
10	GND	Analog Ground.
11	LED5	LED5 current sink.
12	LED4	LED4 current sink.
13	LED3	LED3 current sink.
14	LED2	LED2 current sink.
15	LED1	LED1 current sink.
16	VOUT	Buck regulator output voltage sense input.
17	PGND	Power Ground.
18	LX	Inductor connection for buck regulator.
19	VIN	Voltage Input for buck regulator and IC power.
20	EN	Chip enable logic input.
--	EP	Exposed Paddle -- connect to PCB ground plane using multiple vias directly under the IC.

## Pinout Diagram

### UQFN33-20

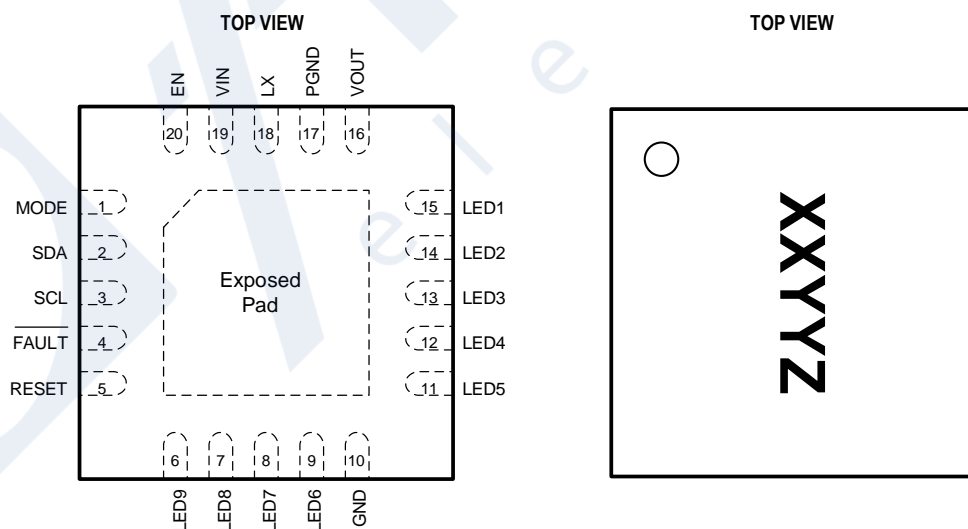

20-Pin 3mm x 3mm x 055mm

UQFN Package, 0.4mm pitch

Top Mark

XX = Device ID Code, YWZ = Date and Assembly Code

### Absolute Maximum Ratings<sup>1</sup>

(T<sub>A</sub> = 25°C unless otherwise noted)

Symbol	Description	Value	Units
	VIN, EN, SCL, SDA, $\overline{\text{FAULT}}$ , RESET, MODE, VOUT, LED1 to LED9	-0.3 to 6	V
	LX	-0.3 to VIN+0.3	V
T <sub>J</sub>	Operating Junction Temperature Range	-40 to 150	°C
T <sub>s</sub>	Storage Temperature Range	-55 to 150	°C
T <sub>LEAD</sub>	Maximum Soldering Temperature (at leads, 10 sec)	260	°C

### ESD Ratings<sup>2</sup>

Symbol	Description	Value	Units
V <sub>ESD_HBM</sub>	ANSI/ESDA/JEDEC JS-001 Human Body Model (HBM, all pins)	±2000	V
V <sub>ESD_CDM</sub>	JESD22-C101 Charge Device Model (CDM, all pins)	±1000	V

### Thermal Capabilities<sup>3</sup>

Symbol	Description	Value	Units
θ <sub>JA</sub>	Thermal Resistance – Junction to Ambient	48	°C/W
P <sub>D</sub>	Maximum Continuous Power Dissipation at 25°C (T <sub>J</sub> = 125°C)	2.08	W
ΔP <sub>D</sub> /ΔT	Derating Factor Above T <sub>A</sub> = 25°C	-20.8	mW/°C

### Ordering Information

Part Number	Marking <sup>4</sup>	Operating Temperature	Package
KTD2041EUAC-TR	XXYYZ	-40°C to +85°C	UQFN33-20

- Stresses above those listed in Absolute Maximum Ratings may cause permanent damage to the device. Functional operation at conditions other than the operating conditions specified is not implied. Only one Absolute Maximum rating should be applied at any one time.
- ESD Ratings conform to JEDEC industry standards. Some pins may actually have higher performance. Ratings apply with chip enabled, disabled, or unpowered, unless otherwise noted.
- Junction to Ambient thermal resistance is highly dependent on PCB layout. Values are based on thermal properties of the device when soldered to an EV board.
- XX = Device ID Code, YWZ = Date and Assembly Code.

**Electrical Characteristics<sup>5</sup>**

Unless otherwise noted, the *Min* and *Max* specs are applied over the full operation temperature range of -40°C to +85°C and  $V_{CC} = V_{IN} = 2.5V$  to  $5.5V$ . Typical values are specified at  $T_A = +25^\circ C$  with  $V_{IN} = 3.6V$ .

Symbol	Description	Conditions	Min	Typ	Max	Units
<b>IC Supply</b>						
V <sub>IN</sub>	Input Operating Range		2.7		5.5	V
V <sub>UVLO</sub>	Under-Voltage Lockout Threshold	V <sub>IN</sub> Rising	2.5	2.6	2.7	V
		V <sub>IN</sub> Hysteresis		200		mV
V <sub>POR</sub>	Power-On-Reset Threshold	V <sub>IN</sub> Rising		1.8		V
		V <sub>IN</sub> Rising		100		mV
I <sub>q</sub>	No-Load Supply Current (EN = High)	Not switching, all LEDs off		140		μA
		FPWM Mode, all LEDs off		1.6		mA
I <sub>SHDN</sub>	Shutdown Current	EN = Low		0.6	1	μA
<b>Logic Pin Specifications (EN, MODE, FAULT)</b>						
V <sub>IH</sub>	Input Logic High (EN, MODE)		1.1			V
V <sub>IL</sub>	Input Logic Low (EN, MODE)				0.4	V
I <sub>I_LK</sub>	Input Logic Leakage (EN, MODE)	T <sub>A</sub> = 25°C, V <sub>I</sub> = 0V or V <sub>IN</sub>	-1	±0.01	1	μA
R <sub>I_PD</sub>	Input Logic Pull-Down (EN, MODE)	Only connected when V <sub>I</sub> ≤ V <sub>IL</sub> (disconnected when v <sub>i</sub> ≥ V <sub>IH</sub> )		250		kΩ
V <sub>OL</sub>	Output Logic Low (FAULT)				0.4	V
<b>Buck Regulator</b>						
R <sub>DSON_H</sub>	High-Side FET On-Resistance			200		mΩ
R <sub>DSON_L</sub>	Low-Side FET On-Resistance			100		mΩ
I <sub>LIM</sub>	Peak Current Limit Threshold			750		mA
I <sub>ZCD</sub>	Zero Crossing Threshold	Skip Mode		50		mA
F <sub>SW</sub>	Switching Frequency			1		MHz
<b>Current Sink</b>						
I <sub>LED_SET</sub>	Current Setting Range	64 steps of 0.5mA/step	0		32	mA
I <sub>LED_ACC</sub>	Current Sink Accuracy	I <sub>LED_ON</sub> = 32mA setting		±2		%
I <sub>LED_MATCH</sub>	Current Sink Matching	I <sub>LED_ON</sub> = 32mA setting		±1		%
V <sub>SOV</sub>	Current sink over-voltage threshold			1.2		V
V <sub>SINK</sub>	Headroom Voltage of Current Sink	I <sub>LED_ON</sub> = 25mA setting		0.10		V
I <sub>LED_LK</sub>	Current Sink Leakage	0mA setting or shutdown		0.01	1	μA
<b>Thermal Shutdown</b>						
T <sub>SD</sub>	Junction Thermal Shutdown Threshold	T <sub>J</sub> rising		150		°C
	Junction Thermal Shutdown Hysteresis	Hysteresis		20		°C

5. Device is guaranteed to meet performance specifications over the -40°C to +85°C operating temperature range by design, characterization and correlation with statistical process controls.

**Electrical Characteristics (continued)<sup>5</sup>**

Unless otherwise noted, the *Min* and *Max* specs are applied over the full operation temperature range of -40°C to +85°C and  $V_{CC} = V_{IN} = 2.5V$  to  $5.5V$ . Typical values are specified at  $T_A = +25^\circ C$  with  $V_{IN} = 3.6V$ .

Symbol	Description	Conditions	Min	Typ	Max	Units
<b>I<sup>2</sup>C-Compatible Interface Specifications (SCL, SDA), see Figure 1</b>						
V <sub>IH</sub>	Input Logic High Threshold		1.1			V
V <sub>IL</sub>	Input Logic Low Threshold				0.4	V
V <sub>OL</sub>	SDA Output Logic Low	I <sub>SDA</sub> = 3mA			0.4	V
t <sub>1</sub>	SCL clock period		2.5			μs
t <sub>2</sub>	Data in setup time to SCL high		100			ns
t <sub>3</sub>	Data out stable after SCL low		0			ns
t <sub>4</sub>	SDA low setup time to SCL low (Start)		100			ns
t <sub>5</sub>	SDA high hold time after SCL high (Stop)		100			ns

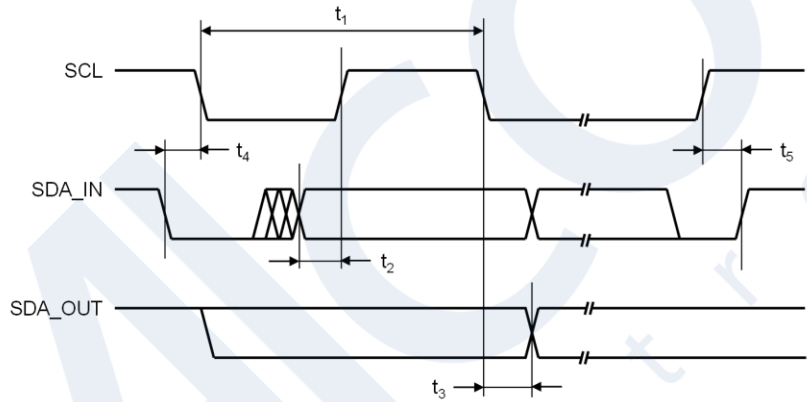
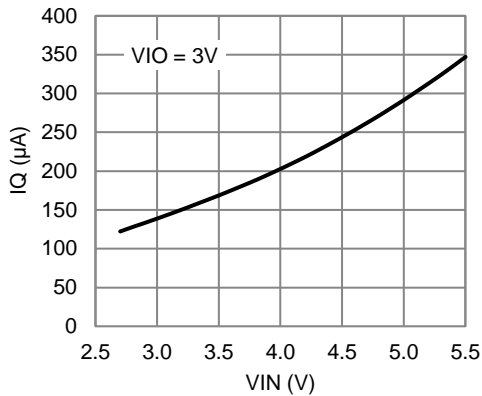

**Figure 1. I<sup>2</sup>C Compatible Interface Timing Diagram**

## Typical Characteristics

Unless otherwise noted,  $V_{IN} = 3.6V$ , 9P1S infrared LEDs, Global LED mode, EN = High, MODE = High (Skip mode), RESET = Low, COU<sub>T</sub> = 22 $\mu$ F, L = 4.7 $\mu$ H (DFE252012P-4R7M=P2 from Murata) and  $T_A = 25^\circ C$ .

**IQ vs. VIN**  
(Skip Mode, No Load)



**IQ vs. VIN**  
(Fixed PWM Mode, No Load)

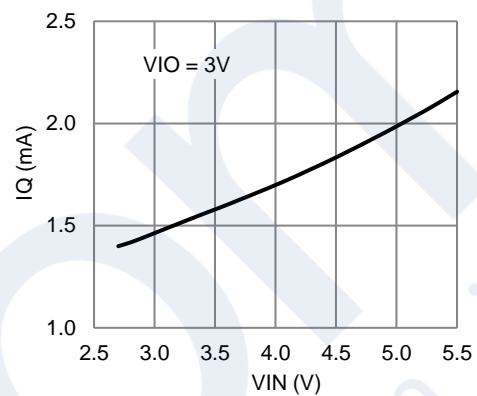

**Shutdown Current vs. VIN**  
(VIO = 3V)

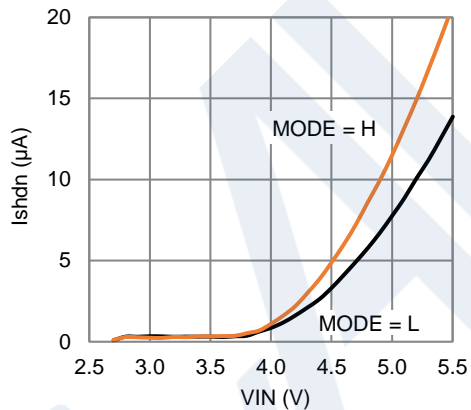

**Switching Frequency vs. VIN**  
(Global ILED = 10mA)

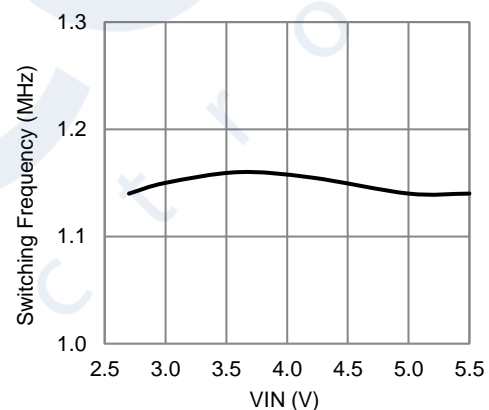

**LED Current vs. VIN**  
(Fixed PWM & Skip mode, Global ILED = 10mA)

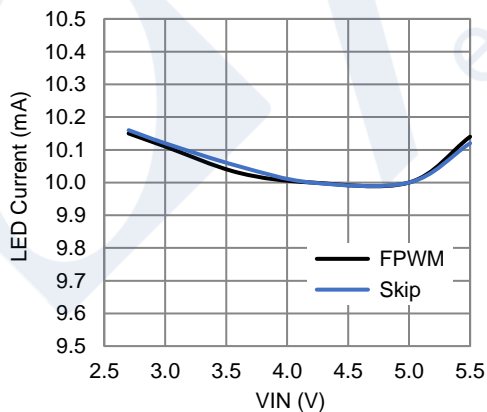

**LED Current vs. VIN**  
(Global ILED = 1.2mA)

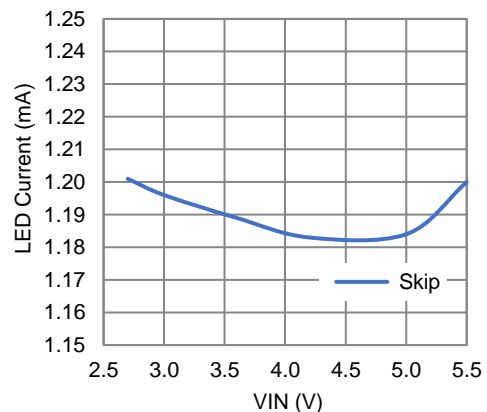

**Typical Characteristics**

Unless otherwise noted,  $V_{IN} = 3.6V$ , 9P1S infrared LEDs, Global LED mode, EN = High, MODE = High (Skip mode), RESET = Low, COU<sub>T</sub> = 22 $\mu$ F, L = 4.7 $\mu$ H (DFE252012P-4R7M=P2 from Murata) and  $T_A = 25^\circ C$ .

**LED Efficiency vs. ILED**  
(9 channels, Skip-mode,  $V_{IN} = 3.6V$ )

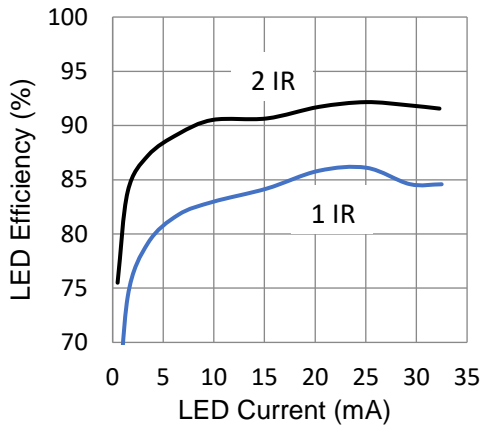

**Buck Efficiency v. ILED**  
(9 channels, Skip-mode,  $V_{IN} = 3.6V$ )

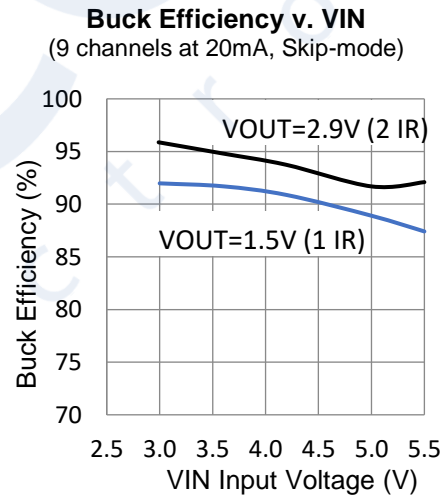
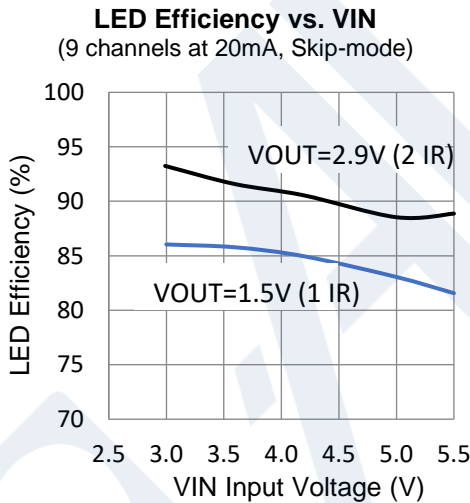
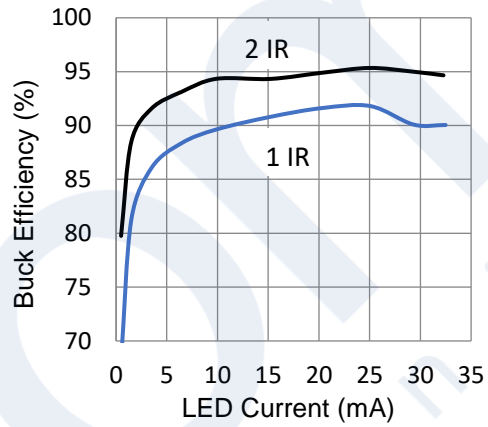

Note: For 1 IR LED per channel at 20mA, VOUT = 1.5V. For 2 IR LEDs per channel at 20mA, VOUT = 2.9V.

## Typical Characteristics

Unless otherwise noted,  $V_{IN} = 3.6V$ , 9P1S infrared LEDs, Global LED mode, EN = High, MODE = High (Skip mode), RESET = Low, COU<sub>T</sub> = 22 $\mu$ F, L = 4.7 $\mu$ H (DFE252012P-4R7M=P2 from Murata) and  $T_A = 25^\circ C$ .

**Turn on by I2C Global LED**  
(9 channels at 20mA, Skip mode)

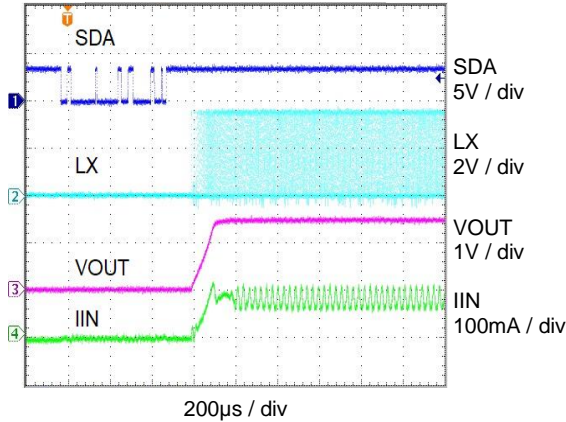

**Switching Waveform Global LED**  
(9 channels at 20mA, fixed PWM mode)

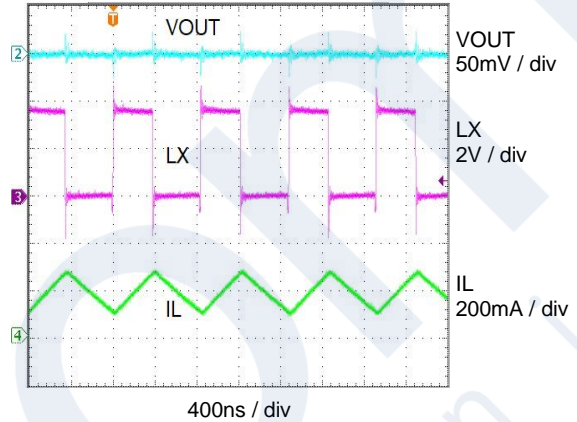

**Switching waveform Global LED**  
(9 LEDs at 1.2mA/channel, Skip mode)

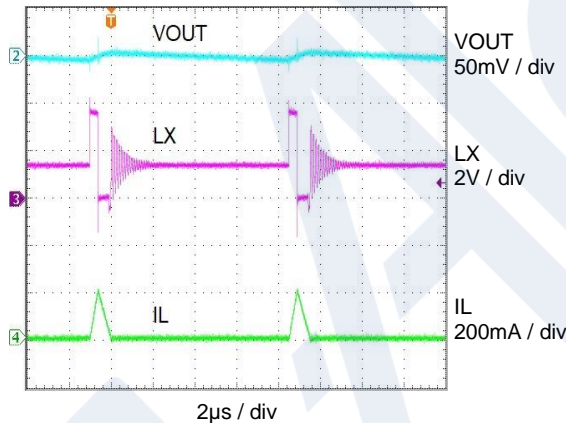

**VOUT short to GND Response**  
(auto restart)

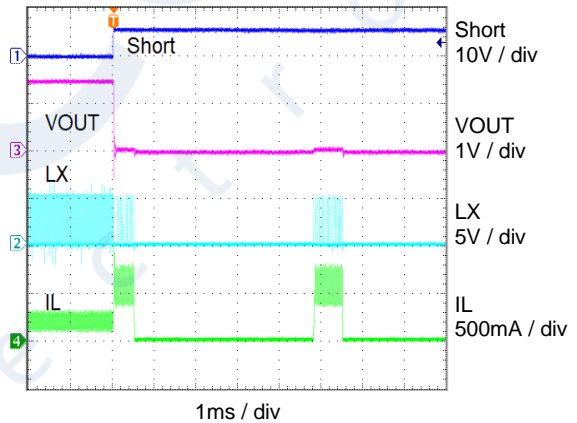

**Turn on with an Open LED**  
(9 LEDs at 20mA, Global LED)

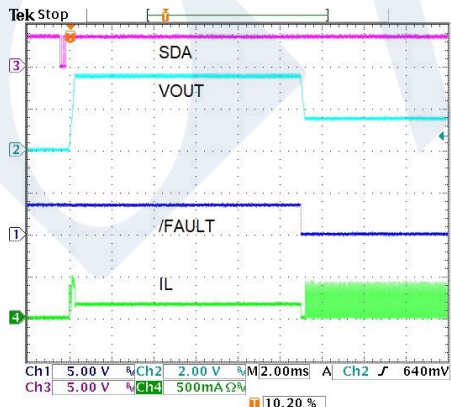

**Turn on with a Short LED4**  
(9 LEDs at 20mA, Global LED)

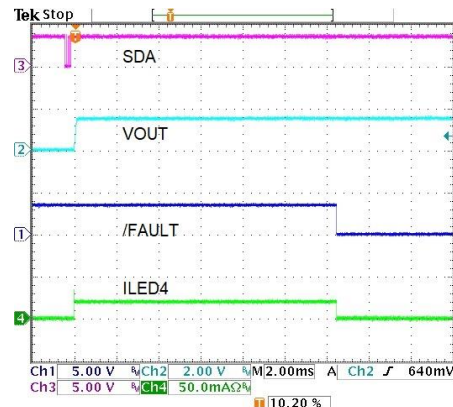



## Functional Block Diagram

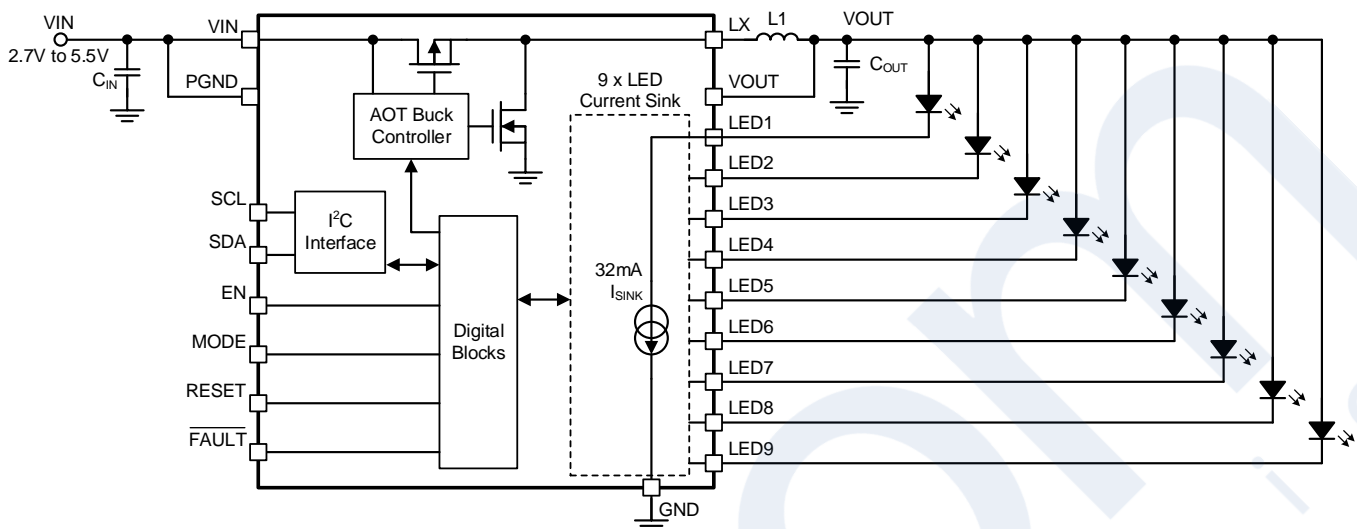

Functional Block Diagram

## Functional Description

### Overview

KTD2041 is a 9-channel LED driver with integrated buck converter with independent control of each channel. It can be powered from a Li-ion battery or a supply voltage up to 5.5V to provide a lower output voltage for driving the LEDs with a minimum sink voltage around 100mV.

The ideal application is driving infrared LEDs (IR LEDs) in a battery-powered video camera where each LED channel can be turned on/off dynamically in order to focus the light toward a particular direction while optimizing the power efficiency.

Applications powered from a Lithium-ion battery or supply voltage above 3V are compatible with 2 IR LEDs or a single white LED per channel.

High switching frequency of the step-down converter allows the use of smaller inductors and capacitors.

The LED driver nine regulated current sinks can support current up to 32mA per channel with 6-bit linear dimming resolution programmable via I<sup>2</sup>C bus.

Various protection features are built into KTD2041, including inductor current limit protection, output short circuit protection, output over-voltage protection, LED fault (open or short) protection and thermal shutdown protection. The device is equipped with I<sup>2</sup>C interface for various controls and status monitor.

### Hardware Enable

KTD2041 has a logic input EN pin to enable/disable the device. When EN pin is set low, the device goes into shutdown mode, but the I<sup>2</sup>C registers are not reset to their default values and the I<sup>2</sup>C bus remains enabled. Under this condition, it is possible to write and read to the registers.

When EN pin goes from low to high, the device becomes enabled and configured according to the current register values.

## Buck Configuration

When EN pin is high, the buck can be enabled or disabled by programming the register 0x11 bit [3] to 1 and bit [2] to 1 for Enable or 0 to Disable.

The buck switching mode can be set to Forced-PWM or Auto-skip mode by the MODE pin or by software.

To select buck mode by MODE pin, set MODE pin Low for Forced-PWM or set MODE pin High for Auto-Skip mode at light load.

To select buck mode by software, write register 0x11 bit [1] to 1 and bit [0] to 0 for Forced-PWM, or bit [0] to 1 for Auto-Skip mode.

## LED Current Setting

The nine LED current sinks can be controlled globally or individually.

### Global LED mode

To control the LEDs globally, select Global LED mode by setting LED\_CONFIG register 0x02 bit [7] to 1.

To identify how many LEDs are included in the Global LED mode, write to register 0x02 bits [2:5] as follows.

- 0000 = All 9 channels are used
- 0001 = 1 channel (LED9) is not used
- 0010 = 2 channels (LED9, LED8) are not used
- ...
- 1111 = 8 channels (LED9, LED8, LED7, LED6, LED5, LED4, LED3, LED2) are not used

To select Global LED Current setting between 0.5mA and 32mA, write the brightness code in register 0x04 bits [5:0].

To program the LED current ( $I_{LED}$ ), the Global Current register code is set according to the following formula:

$$I_{LED} = (1 + code) \times 0.5mA$$

$$code = 39 \text{ decimal} = 0x27 \text{ corresponds to } I_{LED} = 20mA$$

To enable the Global LEDs, write register 0x02 bit [1] to 1. To disable the Global LEDs, write register 0x02 bit [1] to 0.

### Individual LED mode

To control the LEDs individually, select individual LED mode by setting register 0x02 bit [7] to 0.

To set individual LED Current settings between 0.5mA and 32mA, write the brightness codes in registers 0x05 to 0x0D bits [5:0] for respectively LED1 to LED9 settings.

To program each individual LED current ( $I_{LEDX}$ ), the Individual Current registers are set according to the following formula:

$$I_{LEDX} = (1 + code) \times 0.5mA$$

$$\text{For example, code} = 33 \text{ decimal} = 0x21 \text{ corresponds to } I_{LEDX} = 17mA$$

To enable the individual LED1, write register 0x02 bit [0] to 1. To enable the individual LED2 to LED9, write register 0x03 bits [7:0] to 1.

To disable individual LEDs, write the corresponding bits of registers 0x02 or 0x03 to 0.

## Open LED, Short LED

Each current sink is protected against LED short or LED open conditions.

In case of an LED open condition, the current sink voltage of the open channel remains close to 0V and the converter drives the output voltage as high as possible operating in linear mode (not switching) with VOUT following VIN. With the sink pin voltage failing to regulate, a fault is triggered with the /FAULT output going low. The Open LED channel is turned off, the buck converter regulates VOUT voltage lower and drive the other channels normally.

The Open LED channel is ignored until the open LED condition is removed and the fault is cleared by either writing register 0x10 Bit [0] to 1, or by toggling the RESET pin high.

If an LED short circuit condition occurs, the current sink pin voltage goes high above the over-voltage threshold  $V_{SOV}$ . A fault is triggered with the /FAULT output going low. The Short LED channel is turned off (no LED current), the buck converter continues to regulate VOUT voltage and drive the other channels.

The Short LED channel stays off until the short LED condition is removed and the fault is cleared by either writing register 0x10 Bit [0] to 1, or by toggling the RESET pin high.

### **Fault Status**

Open LED and Short LED fault status is stored in two Fault Status registers 0x0E and 0x0F.

When an Open LED fault is triggered, Fault Status 0x0E bit [7] is set to 1 and the associated register 0x0E or 0x0F LED channel bits are set to 1 to report the Open channels.

When a Short LED fault is triggered, Fault Status 0x0E bit [6] is set to 1 and the associated register 0x0E or 0x0F LED channel bits are set to 1 to report the Short channels.

LED faults can be cleared by either writing to a register bit or toggling the RESET pin as follows.

- Writing a 1 into register 0x10 bit [0]. This is a Write only bit.
- Toggling the RESET pin high.

VIN supply voltage and device operation fault status are stored in registers 0x0F and 0x13. For more details, please refer to the registers description.

### **Fault Output Pin**

When an Open LED or Short LED fault is triggered, the open-drain output /FAULT pin is pulled low. Once all Open LED and Short LED fault conditions are removed and LED faults are cleared, the /FAULT output is released and return high.

## Application Information

### I<sup>2</sup>C Serial Data Bus

KTD2041 supports the I<sup>2</sup>C bus protocol. A device that sends data onto the bus is defined as a transmitter and a device receiving data as a receiver. The device that controls the bus is called a master, whereas the devices controlled by the master are known as slaves. A master device must generate the serial clock (SCL), control bus access and generate START and STOP conditions to control the bus. KTD2041 operates as a slave on the I<sup>2</sup>C bus. Within the bus specifications a standard mode (100kHz maximum clock rate) and a fast mode (400kHz maximum clock rate) are defined. KTD2041 works in both modes. Connections to the bus are made through the open-drain I/O lines SDA and SCL.

The following bus protocol has been defined in Figure 2:

- Data transfer may be initiated only when the bus is not busy.
- During data transfer, the data line must remain stable whenever the clock line is HIGH. Changes in the data line while the clock line is high are interpreted as control signals.

Accordingly, the following bus conditions have been defined:

#### Bus Not Busy

Both data and clock lines remain HIGH.

#### Start Data Transfer

A change in the state of the data line, from HIGH to LOW, while the clock is HIGH, defines a START condition.

#### Stop Data Transfer

A change in the state of the data line, from LOW to HIGH, while the clock line is HIGH, defines the STOP condition.

#### Data Valid

The state of the data line represents valid data when, after a START condition, the data line is stable for the duration of the HIGH period of the clock signal. The data on the line must be changed during the LOW period of the clock signal. There is one clock pulse per bit of data.

Each data transfer is initiated with a START condition and terminated with a STOP condition. The number of data bytes transferred between START and STOP conditions are not limited and are determined by the master device. The information is transferred byte-wise and each receiver acknowledges with a ninth bit.

#### Acknowledge

Each receiving device, when addressed, is obliged to generate an acknowledge after the reception of each byte. The master device must generate an extra clock pulse that is associated with this acknowledge bit.

A device that acknowledges must pull down the SDA line during the acknowledge clock pulse in such a way that the SDA line is stable LOW during the HIGH period of the acknowledge-related clock pulse. Setup and hold times must also be taken into account.

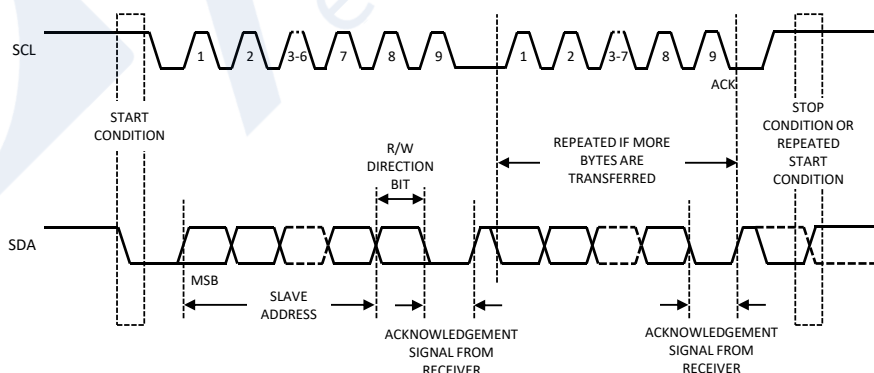

**Figure 2. Data Transfer on I<sup>2</sup>C Serial Bus**

KTD2041 7-bit slave device address is 0100000 binary (0x20h).

There are two kinds of I<sup>2</sup>C data transfer cycles: write cycle and read cycle.

## I<sup>2</sup>C Write Cycle

For I<sup>2</sup>C write cycle, data is transferred from a master to a slave. The first byte transmitted is the 7-bit slave address plus one bit of '0' for write. Next follows a number of data bytes. The slave returns an acknowledge bit after each received byte. Data is transferred with the most significant bit (MSB) first. Figure 3 shows the sequence of the I<sup>2</sup>C write cycle.

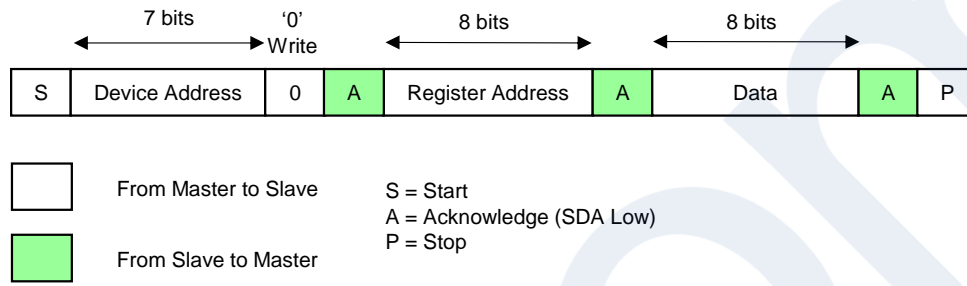

**Figure 3. I<sup>2</sup>C Write Cycle**

### I<sup>2</sup>C Write Cycle Steps:

- Master generates start condition.
- Master sends 7-bit slave address (0100000 for KTD2041) and 1-bit data direction '0' for write.
- Slave sends acknowledge if the slave address is matched.
- Master sends 8-bit register address.
- Slave sends acknowledge.
- Master sends 8-bit data for that addressed register.
- Slave sends acknowledge.
- If master sends more data bytes, the register address will be incremented by one after each acknowledge.
- Master generates stop condition to finish the write cycle.

## I<sup>2</sup>C Read Cycle

For I<sup>2</sup>C read cycle, data is transferred from a slave to a master. But to start the read cycle, master needs to write the register address first to define which register data to read. Figure 4 shows the steps of the I<sup>2</sup>C read cycle.

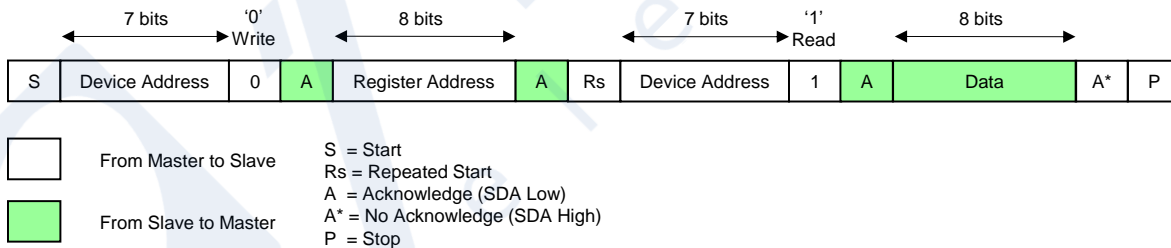

**Figure 4. I<sup>2</sup>C Read Cycle**

### I<sup>2</sup>C Read Cycle Steps:

- Master generates start condition.
- Master sends 7-bit slave address (0100000 for KTD2041) and 1-bit data direction '0' for write.
- Slave sends acknowledge if the slave address is matched.
- Master sends 8-bit register address.
- Slave sends acknowledge.
- Master generates repeated start condition.
- Master sends 7-bit slave address (0100000 for KTD2041) and 1-bit data direction '1' for read.
- Slave sends acknowledge if the slave address is matched.

- Slave sends the data byte of that addressed register.
- If master sends acknowledge, the register address will be incremented by one after each acknowledge and the slave will continue to send the data for the updated addressed register.
- If master sends no acknowledge, the slave will stop sending the data.
- Master generates stop condition to finish the read cycle.

## I<sup>2</sup>C Register Map

Table 1 summarizes KTD2041 I<sup>2</sup>C registers, their read/write settings and default values. The registers can only be reset to their default values by VIN power on reset. Toggling EN pin does not reset the registers to their default values.

**Table 1. I<sup>2</sup>C Register Map**

Hex Address	Register Name	Access	Default Value
0x00	CHIP_ID	R	0xA9
0x01	MONITOR	R	0x00
0x02	LED_CONFIG	R/W	0x00
0x03	LED_EN_IDVD	R/W	0x00
0x04	LED_GBAL_SET	R/W	0x00
0x05	LED1_SET	R/W	0x00
0x06	LED2_SET	R/W	0x00
0x07	LED3_SET	R/W	0x00
0x08	LED4_SET	R/W	0x00
0x09	LED5_SET	R/W	0x00
0x0A	LED6_SET	R/W	0x00
0x0B	LED7_SET	R/W	0x00
0x0C	LED8_SET	R/W	0x00
0x0D	LED9_SET	R/W	0x00
0x0E	FAULT_STAT1	R	0x00
0x0F	FAULT_STAT2	R	0x00
0x10	FAULT_CLEAR	W/C	0x00
0x11	BUCK_CONFIG	R/W	0x00
0x13	STATUS	R	0x00

**Table 2. CHIP\_ID Register**

ADDRESS	MODE		RESET VALUE: 0xA9
0x00	R		
BIT	NAME	POR	DESCRIPTION
7:5	VENDOR	101	Vendor Identification 101 = Kinetic Technologies
4:0	DIE_ID	01001	Die identification

Note: POR for Power-on reset or reset value

**Table 3. MONITOR Register**

ADDRESS	MODE		RESET VALUE: 0x00
0x01	R		
BIT	NAME	POR	DESCRIPTION
7:4	RSVD	000	Reserved
3:0	DIE_REV	xxxx	Die revision identification

**Table 4. LED\_CONFIG Register**

ADDRESS	MODE		RESET VALUE: 0x00
0x02	R/W		
BIT	NAME	POR	DESCRIPTION
7	Ctrl_Mode_LED	0	0 : individual, 1 : global LED control
6	RSVD	0	Reserved
5	Global_LED_Channel [3:0]	0	0000 = All 9 channels are used
4		0	0001 = 1 channel (LED9) is not used
3		0	0010 = 2 channels (LED9, LED8) are not used
2		0	1111 = 8 channels (LED9, LED8, LED7, LED6, LED5, LED4, LED3, LED2) are not used
1	Global_EN_LED	0	LEDx enable in global control mode, 0 = Disable, 1 = Enable
0	EN_LED1	0	LED1 enable in individual control mode, 0 = Disable, 1 = Enable

**Table 5. LED\_EN\_IDVD Register**

ADDRESS	MODE		RESET VALUE: 0x00
0x03	R/W		
BIT	NAME	POR	DESCRIPTION
7	EN_LED2	0	LED2 enable in individual control mode, 0 = Disable, 1 = Enable
6	EN_LED3	0	LED3 enable in individual control mode, 0 = Disable, 1 = Enable
5	EN_LED4	0	LED4 enable in individual control mode, 0 = Disable, 1 = Enable
4	EN_LED5	0	LED5 enable in individual control mode, 0 = Disable, 1 = Enable
3	EN_LED6	0	LED6 enable in individual control mode, 0 = Disable, 1 = Enable
2	EN_LED7	0	LED7 enable in individual control mode, 0 = Disable, 1 = Enable
1	EN_LED8	0	LED8 enable in individual control mode, 0 = Disable, 1 = Enable
0	EN_LED9	0	LED9 enable in individual control mode, 0 = Disable, 1 = Enable

**Table 6. LED\_GBAL\_SET Register**

ADDRESS	MODE		RESET VALUE: 0x00
0x04	R/W		
BIT	NAME	POR	DESCRIPTION
7:6	RSVD	0	Reserved
5:0	LED_Global_Current [5:0]	0	Set LED current in Global Control Mode $I_{LED} = (DEC ([5:0]) * 0.5mA) + 0.5mA$ 000000 = 0.5mA 000010 = 1mA ... 111110 = 31.5mA 111111 = 32mA

**Table 7. LED1\_SET Register**

ADDRESS	MODE		RESET VALUE: 0x00
0x05	R/W		
BIT	NAME	POR	DESCRIPTION
7:6	RSVD	0	Reserved
5:0	LED1_Current [5:0]	0	Set LED current in Individual control mode $I_{LED} = (DEC ([5:0]) * 0.5mA) + 0.5mA$ 000000 = 0.5mA 000010 = 1mA ... 111110 = 31.5mA 111111 = 32mA

**Table 8. LED2\_SET Register**

ADDRESS	MODE		RESET VALUE: 0x00
0x06	R/W		
BIT	NAME	POR	DESCRIPTION
7:6	RSVD	0	Reserved
5:0	LED2_Current [5:0]	0	Set LED current in Individual control mode $I_{LED} = (DEC ([5:0]) * 0.5mA) + 0.5mA$ 000000 = 0.5mA 000010 = 1mA ... 111110 = 31.5mA 111111 = 32mA

**Table 9. LED3\_SET Register**

ADDRESS	MODE		RESET VALUE: 0x00
0x06	R/W		
BIT	NAME	POR	DESCRIPTION
7:6	RSVD	0	Reserved
5:0	LED3 Current [5:0]	0	Set LED current in Individual control mode $I_{LED} = (DEC ([5:0]) * 0.5mA) + 0.5mA$ 000000 = 0.5mA 000010 = 1mA ... 111110 = 31.5mA 111111 = 32mA

**Table 10. LED4\_SET Register**

ADDRESS	MODE		RESET VALUE: 0x00
0x06	R/W		
BIT	NAME	POR	DESCRIPTION
7:6	RSVD	0	Reserved
5:0	LED4_Current [5:0]	0	Set LED current in Individual control mode $I_{LED} = (DEC ([5:0]) * 0.5mA) + 0.5mA$ 000000 = 0.5mA 000010 = 1mA ... 111110 = 31.5mA 111111 = 32mA



**Table 11. LED5\_SET Register**

ADDRESS	MODE		RESET VALUE: 0x00
0x06	R/W		
BIT	NAME	POR	DESCRIPTION
7:6	RSVD	0	Reserved
5:0	LED5_Current [5:0]	0	Set LED current in Individual control mode $I_{LED} = (DEC ([5:0]) * 0.5mA) + 0.5mA$ 000000 = 0.5mA 000010 = 1mA ... 111110 = 31.5mA 111111 = 32mA

**Table 12. LED6\_SET Register**

ADDRESS	MODE		RESET VALUE: 0x00
0x07	R/W		
BIT	NAME	POR	DESCRIPTION
7:6	RSVD	0	Reserved
5:0	LED6_Current [5:0]	0	Set LED current in Individual control mode $I_{LED} = (DEC ([5:0]) * 0.5mA) + 0.5mA$ 000000 = 0.5mA 000010 = 1mA ... 111110 = 31.5mA 111111 = 32mA

**Table 13. LED7\_SET Register**

ADDRESS	MODE		RESET VALUE: 0x00
0x08	R/W		
BIT	NAME	POR	DESCRIPTION
7:6	RSVD	0	Reserved
5:0	LED7_Current [5:0]	0	Set LED current in Individual control mode $I_{LED} = (DEC ([5:0]) * 0.5mA) + 0.5mA$ 000000 = 0.5mA 000010 = 1mA ... 111110 = 31.5mA 111111 = 32mA

**Table 14. LED8\_SET Register**

ADDRESS	MODE		RESET VALUE: 0x00
0x09	R/W		
BIT	NAME	POR	DESCRIPTION
7:6	RSVD	0	Reserved
5:0	LED8_Current [5:0]	0	Set LED current in Individual control mode $I_{LED} = (DEC ([5:0]) * 0.5mA) + 0.5mA$ 000000 = 0.5mA 000010 = 1mA ... 111110 = 31.5mA 111111 = 32mA

**Table 15. LED9\_SET Register**

ADDRESS	MODE		RESET VALUE: 0x00
0x10	R/W		
BIT	NAME	POR	DESCRIPTION
7:6	RSVD	0	Reserved
5:0	LED9_Current [5:0]	0	Set LED current in Individual control mode $I_{LED} = (DEC ([5:0]) * 0.5mA) + 0.5mA$ 000000 = 0.5mA 000010 = 1mA ... 111110 = 31.5mA 111111 = 32mA

**Table 16. FAULT\_STAT1 Register**

ADDRESS	MODE		RESET VALUE: 0x00
0x0E	R		
BIT	NAME	POR	DESCRIPTION
7	OPEN_LED	0	Open LED Fault, 0 = No fault, 1 = Fault detected
6	SHORT_LED	0	Short LED Fault, 0 = No fault, 1 = Fault detected
5	LED1_Fault	0	Report LED1 Channel has either short or open LED, 0 = No fault, 1 = Fault detected
4	LED2_Fault	0	Report LED2 Channel has either short or open LED, 0 = No fault, 1 = Fault detected
3	LED3_Fault	0	Report LED3 Channel has either short or open LED, 0 = No fault, 1 = Fault detected
2	LED4_Fault	0	Report LED4 Channel has either short or open LED, 0 = No fault, 1 = Fault detected
1	LED5_Fault	0	Report LED5 Channel has either short or open LED, 0 = No fault, 1 = Fault detected
0	LED6_Fault	0	Report LED6 Channel has either short or open LED, 0 = No fault, 1 = Fault detected

**Table 17. FAULT\_STAT2 Register**

ADDRESS	MODE		RESET VALUE: 0x00
0x0F	R		
BIT	NAME	POR	DESCRIPTION
7	LED7_Fault	0	Report LED7 Channel has either short or open LED, 0 = No fault, 1 = Fault detected
6	LED8_Fault	0	Report LED8 Channel has either short or open LED, 0 = No fault, 1 = Fault detected
5	LED9_Fault	0	Report LED9 Channel has either short or open LED, 0 = No fault, 1 = Fault detected
4	RSVD	0	Reserved for future use
3	VIN_OVLO_Fault	0	Buck input OVLO Fault
2	BUCK_OCP_Fault	0	Buck output OCP Fault
1	TJ_OVERTEMP_Fault	0	over temperature Fault, die temperature is greater than 150°C
0	RSVD	0	Reserved for future use

**Table 18. FAULT\_CLEAR Register**

ADDRESS	MODE		RESET VALUE: 0x00
0x10	W/C		
BIT	NAME	POR	DESCRIPTION
7:1	RSVD	0	Reserved for future use
0	Clear_Faults		Write high (1) to clear faults, WRITE only

**Table 19. BUCK\_CONFIG Register**

ADDRESS	MODE		RESET VALUE: 0x00
0x11	W/R		
BIT	NAME	POR	DESCRIPTION
7:4	RSVD	0	Reserved for future use
3	Sel_en_sw	0	Select the enable buck, 0: by Pin, 1: by Register
2	Buck_en_sw	0	Enable Buck by software when Sel_en_sw = 1 and EN pin is High
1	Sel_mode	0	Select the mode control, 0: by Pin, 1: by Register
0	Mode_sw	0	Mode control bit with Sel_mode = 1, 0: Forced-PWM, 1: Auto-Skip

**Table 20. STATUS Register**

ADDRESS	MODE		RESET VALUE: 0x00
0x13	R		
BIT	NAME	POR	DESCRIPTION
7:5	RSVD	0	Reserved for future use
4	VIN_UVLO_STAT	0	VIN under voltage status; 1 when VIN < UVLO
3	VIN_OVLO_STAT	0	VIN over voltage status; 1 when VIN > OVLO
2	BUCK_OCP_STAT	0	Buck output over current protection status; 1 when IOOUT > OC
1	TJ_OVERTEMP_STAT	0	Junction over temperature status; 1 when T <sub>J</sub> > 150°C
0	RSVD	0	Reserved for future use

## Packaging Information

UQFN33-20 (3.00mm x 3.00mm x 0.55mm)

Top View

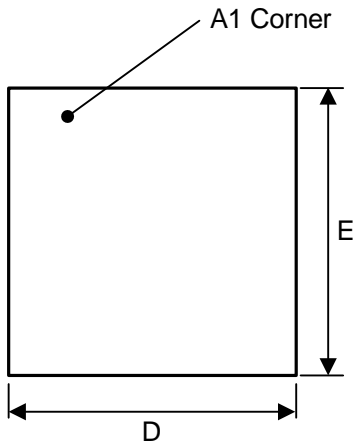

Bottom View

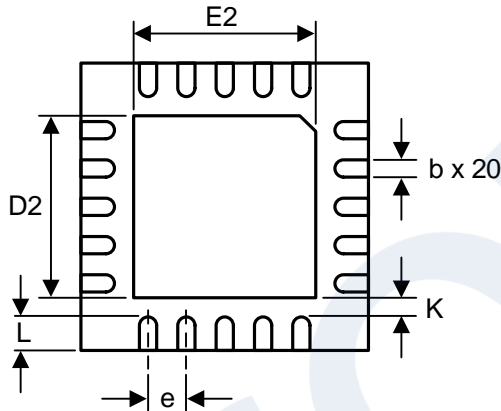

Side View

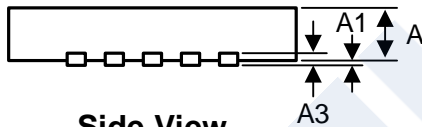

Dimension	mm		
	Min.	Typ.	Max.
A	0.45	0.55	0.60
A1	0.00	-	0.05
A3	0.127 REF		
b	0.13	0.18	0.23
D	2.90	3.00	3.10
D2	1.80	1.90	2.00
E	2.90	3.00	3.10
E2	1.80	1.90	2.00
e	0.40 BSC		
L	0.30	0.35	0.40
K	0.20 REF		

### Recommended Footprint

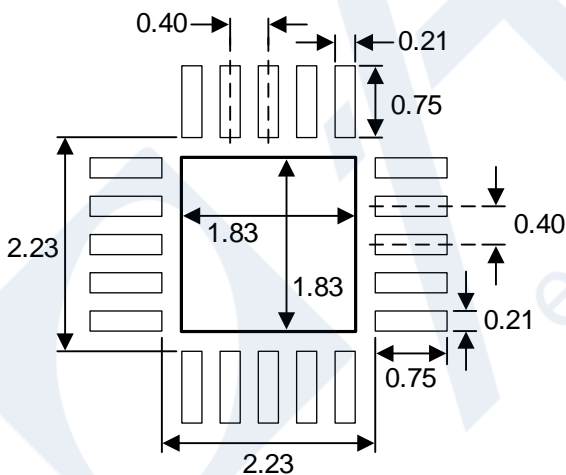

Kinetic Technologies cannot assume responsibility for use of any circuitry other than circuitry entirely embodied in a Kinetic Technologies product. No intellectual property or circuit patent licenses are implied. Kinetic Technologies reserves the right to change the circuitry and specifications without notice at any time.