

## Features

- Full Power at Wide Output Current Range (Constant Power)
- Adjustable Output Current (AOC) with Programmability
- Isolated 1(0)-5V/1(0)-10V/10V PWM/3-Timer-Modes
- Adjustable Dimming Curve
- High Reliability & Long Lifetime: 119,000 hrs. at 70°C Case Temperature
- Dim-to-Low-Voltage with Standby Power  $\leq 0.5W$
- Output Lumen Compensation
- End-of-Life Indicator
- Input Surge Protection: DM 4kV, CM 6kV
- All-Around Protection: OVP, SCP, OTP
- IP66/IP67 (HV models)
- IP66 and UL Dry/Damp Location (HF models)
- SELV Output
- TYPE HL, for use in a Class I, Division 2 Hazardous (Classified) Location
- Suitable for Class I Luminaires
- 5 Years Warranty

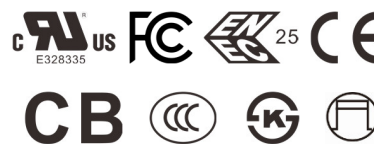

## Description

The EUC-040SxxxHx series is a 40W, constant-current IP66/IP67 LED driver that operates from 90-305Vac input with excellent power factor. It is created for many lighting applications including tunnel and street, etc. The high efficiency of these drivers and compact metal case enable them to run cooler, significantly improving reliability and extending product life. To ensure trouble-free operation, protection is provided against input surge, output over voltage, short circuit, and over temperature.

## Models

Adjustable Output Current Range(mA)	Full-Power Current Range(mA) <sup>(1)</sup>	Default Output Current(mA)	Output Voltage Range(Vdc)	Max. Output Power(W)	Typical Efficiency <sup>(2)</sup>	Typical Power Factor		Model Number <sup>(3)(4)(5)</sup>
						120Vac	220Vac	
50-700	500-700	700	40-80	40	88.5%	0.99	0.96	EUC-040S070Hx
70-1050	700-1050	1050	28-57	40	87.5%	0.99	0.96	EUC-040S105Hx

**Notes:** (1) Output current range with constant power at 40W

(2) Measured at 100% load and 220Vac input (see below "General Specifications" for details).

(3) Certified input voltage range: UL, FCC 100-277Vac; otherwise 100-240Vac.

(4) SELV output.

(5) x = V are ENEC and CCC, etc. models; x = F are UL Recognized, ENEC and CCC, etc. models with flying leads. See below "Mechanical Outline" for details.

## I-V Operation Area

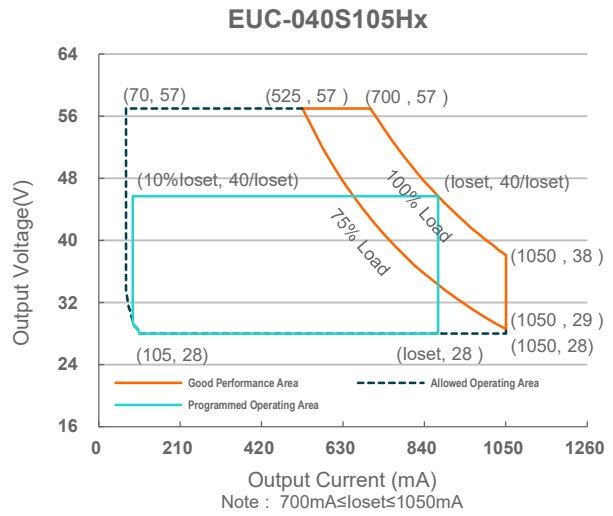
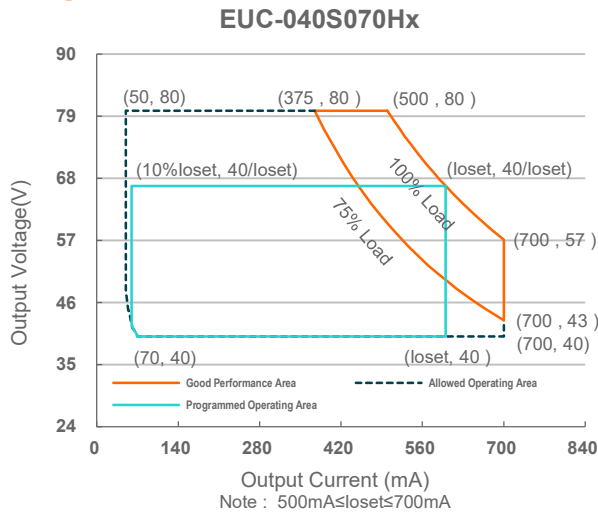

## Input Specifications

Parameter	Min.	Typ.	Max.	Notes
Input AC Voltage	90 Vac	-	305 Vac	
Input DC Voltage	127 Vdc	-	300 Vdc	
Input Frequency	47 Hz	-	63 Hz	
Leakage Current	-	-	0.75 MIU	UL 8750; 277Vac/60Hz
	-	-	0.70 mA	IEC 60598-1; 240Vac/60Hz
Input AC Current	-	-	0.43 A	Measured at 100% load and 120 Vac input.
	-	-	0.24 A	Measured at 100% load and 220 Vac input.
Inrush Current(I <sup>2</sup> t)	-	-	0.001 A <sup>2</sup> s	At 220Vac input, 25°C cold start, duration=37.6 μs, 10%I <sub>pk</sub> -10%I <sub>pk</sub> .
Power Factor	0.90	-	-	120-277Vac, 50-60Hz, 75%-100%Load (30~40W)
THD	-	-	20%	
THD	-	-	15%	120-240Vac, 50-60Hz, 80%-100%Load (32~40W)

## Output Specifications

Parameter	Min.	Typ.	Max.	Notes
Output Current Tolerance	-8%lo	-	8%lo	At 100% load condition, at 120-277Vac
Output Current Setting(Io set) Range				
EUC-040S070Hx	50 mA	-	700 mA	
EUC-040S105Hx	70 mA	-	1050 mA	
Output Current Setting Range with Constant Power				
EUC-040S070Hx	500 mA	-	700 mA	
EUC-040S105Hx	700 mA	-	1050 mA	
Total Output Current Ripple (pk-avg)	-	50%lo	75%lo	At 100% load condition
Startup Overshoot Current	-	5%lo	10%lo	At 100% load condition
No Load Output Voltage				
EUC-040S070Hx	-	-	100 V	
EUC-040S105Hx	-	-	80 V	
Line Regulation	-	-	±5.0%	Measured at 100% load, at 120-277Vac
Load Regulation	-	-	±5.0%	At 120-277Vac
Turn-on Delay Time	-	-	1 s	Measured at 220Vac input.
Temperature Coefficient of Io max	-	0.06%/°C	-	Case temperature = 0°C ~Tc max

**Note:** All specifications are tested by Cree XLamp XP-G2 unless otherwise stated.

## General Specifications

Parameter	Min.	Typ.	Max.	Notes
Efficiency at 120 Vac input: EUC-040S070Hx				Measured at 100% load and steady-state temperature in 25°C ambient; (Efficiency will be about 2.0% lower if measured immediately after startup.)
Io= 500 mA	86.0%	88.0%	-	
Io= 700 mA	85.5%	87.5%	-	
EUC-040S105Hx				
Io= 700 mA	85.0%	87.0%	-	
Io=1050 mA	83.5%	85.5%	-	
Efficiency at 220 Vac input: EUC-040S070Hx				Measured at 100% load and steady-state temperature in 25°C ambient; (Efficiency will be about 2.0% lower if measured immediately after startup.)
Io= 500 mA	86.5%	88.5%	-	
Io= 700 mA	86.5%	88.5%	-	
EUC-040S105Hx				
Io= 700 mA	85.5%	87.5%	-	
Io=1050 mA	84.5%	86.5%	-	
Efficiency at 277 Vac input: EUC-040S070Hx				Measured at 100% load and steady-state temperature in 25°C ambient; (Efficiency will be about 2.0% lower if measured immediately after startup.)
Io= 500 mA	85.5%	87.5%	-	
Io= 700 mA	86.0%	88.0%	-	
EUC-040S105Hx				
Io= 700 mA	85.0%	87.0%	-	
Io=1050 mA	84.0%	86.0%	-	
Standby Power	-	-	0.5 W	Measured at 230Vac/50Hz; Dimming to low voltage
MTBF	-	1120,000 Hours	-	Measured at 220Vac input, 80%Load and 25°C ambient temperature (MIL-HDBK-217F)

## General Specifications (Continued)

Parameter	Min.	Typ.	Max.	Notes
Lifetime	-	119,000 Hours	-	Measured at 220Vac input, 100%Load and 70°C case temperature; See lifetime vs. Tc curve for the details
Operating Case Temperature for Safety Tc_s	-40 °C	-	+90 °C	
Operating Case Temperature for Warranty Tc_w	-40 °C	-	+75 °C	Case temperature for 5 years warranty. Humidity: 10% RH to 95% RH
Storage Temperature	-40 °C	-	+85 °C	Humidity: 5% RH to 95% RH
Dimensions Inches (L × W × H) Millimeters (L × W × H)	3.74 x 2.52 x 1.26 95 x 64 x 32			With mounting ear 4.41 x 2.52 x 1.26 112 x 64 x 32
Net Weight	-	425 g	-	

**Note:** All specifications are tested by Cree XLamp XP-G2 unless otherwise stated.

## Dimming Specifications

Parameter	Min.	Typ.	Max.	Notes	
Absolute Maximum Voltage on the Vdim (+) Pin	-20 V	-	20 V		
Source Current on Vdim (+)Pin	200 µA	300 µA	450 µA	Vdim(+) = 0 V	
Dimming Output Range	EUC-040S070Hx EUC-040S105Hx	10%loset	-	loset	500 mA ≤ loaset ≤ 700 mA 700 mA ≤ loaset ≤ 1050 mA
	EUC-040S070Hx EUC-040S105Hx	50 mA 70 mA	-	loset	50 mA ≤ loaset ≤ 500 mA 70 mA ≤ loaset ≤ 700 mA
Recommended Dimming Input Range	1 V	-	9 V	Default positive 1-10V dimming mode. DTLV can be enable in Inventronics Programing Software.	
Hysteresis	-	0.2 V	-		
Dimming Curve Adjustable	0V	-	10V	Dimming mode set to Adjustable Dimming Curve in Inventronics Programing Software.	
PWM_in High Level	-	10 V	-		
PWM_in Low Level	-	0 V	-		
PWM_in Frequency Range	200 Hz	-	3 KHz		
PWM_in Duty Cycle	0%	-	100%		
Hysteresis	-	2%	-		

## Safety & EMC Compliance

Safety Category	Standard
UL/CUL	UL 8750,CAN/CSA-C22.2 No. 250.13
ENEC & CE	EN 61347-1, EN 61347-2-13
CB	IEC 61347-1, IEC 61347-2-13

## Safety & EMC Compliance (Continued)

Safety Category	Standard
CCC	GB 19510.1, GB 19510.14
KS	KS C 7655
Performance	Standard
ENEC	EN IEC 62384
EMI Standards	Notes
EN IEC 55015/GB/T 17743 <sup>(1)</sup>	Conducted emission Test & Radiated emission Test
EN IEC 61000-3-2/GB 17625.1	Harmonic current emissions
EN 61000-3-3	Voltage fluctuations & flicker
FCC Part 15 <sup>(1)</sup>	ANSI C63.4 Class B
	This device complies with Part 15 of the FCC Rules. Operation is subject to the following two conditions: [1] this device may not cause harmful interference, and [2] this device must accept any interference received, including interference that may cause undesired Operation.
EMS Standards	Notes
EN 61000-4-2	Electrostatic Discharge (ESD): 8 kV air discharge, 4 kV contact discharge
EN 61000-4-3	Radio-Frequency Electromagnetic Field Susceptibility Test-RS
EN 61000-4-4	Electrical Fast Transient / Burst-EFT
EN 61000-4-5	Surge Immunity Test: AC Power Line: Differential Mode 4 kV, Common Mode 6 kV
EN 61000-4-6	Conducted Radio Frequency Disturbances Test-CS
EN 61000-4-8	Power Frequency Magnetic Field Test
EN 61000-4-11	Voltage Dips
EN 61547	Electromagnetic Immunity Requirements Applies To Lighting Equipment

**Note:** (1) This LED driver meets the EMI specifications above, but EMI performance of a luminaire that contains it depends also on the other devices connected to the driver and on the fixture itself.

## Derating

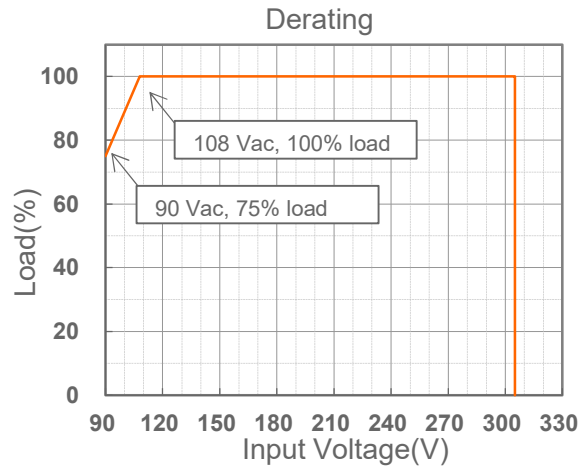

## Lifetime vs. Case Temperature

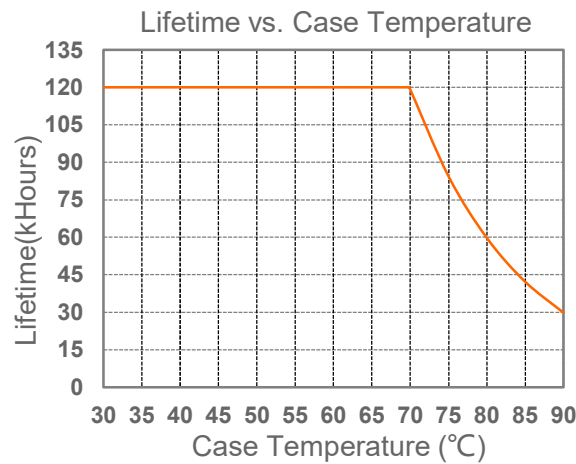

## Inrush Current Waveform

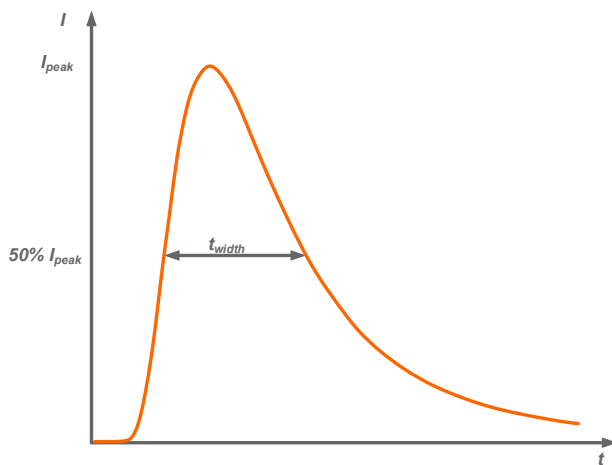

Input AC Voltage	$I_{peak}$	$t_{width}$ (@ 50% $I_{peak}$ )
120Vac	3.23A	45.6 $\mu$ s
220Vac	5.16A	32.0 $\mu$ s
277Vac	7.23A	37.2 $\mu$ s

MCB	Tripping Curves	B	B	B	B	C	C	C	C
	Rated Current	10A	16A	20A	25A	10A	16A	20A	25A
The Number of LED Driver can be Configured	120Vac	15	24	30	38	17	28	35	44
	220Vac	28	45	56	70	32	52	65	82
	277Vac	34	54	68	85	39	63	79	99

## Efficiency vs. Load

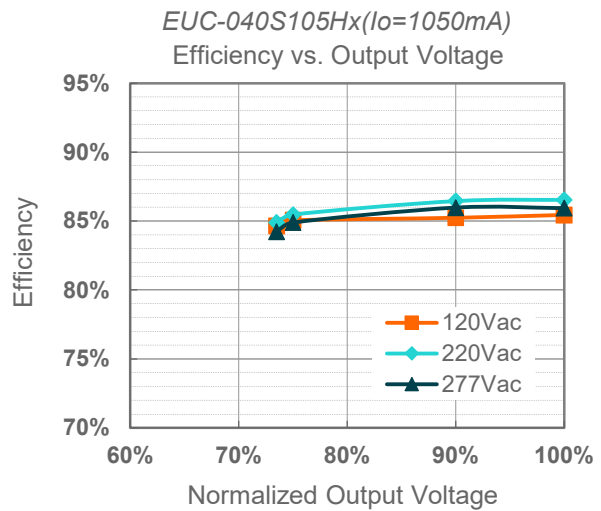
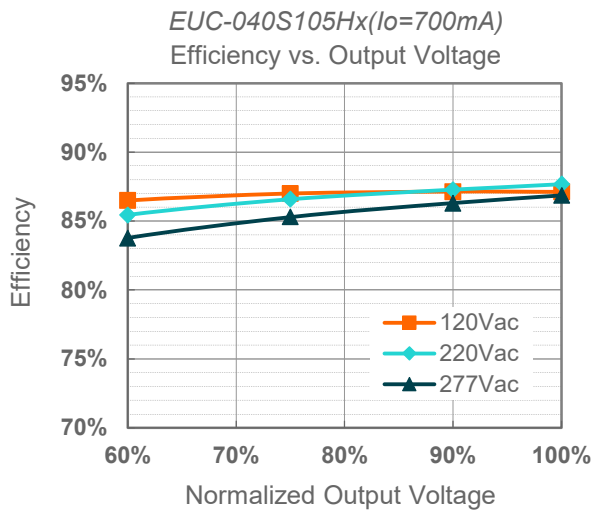
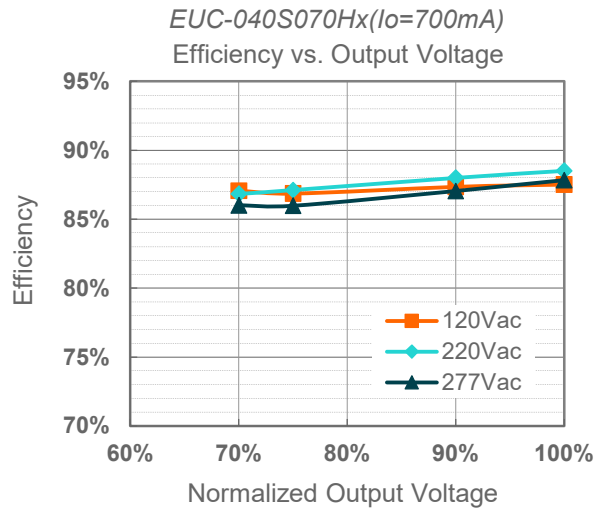
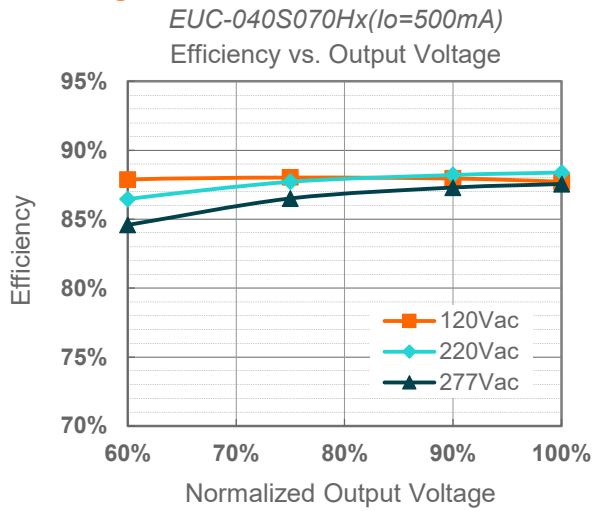

## Power Factor

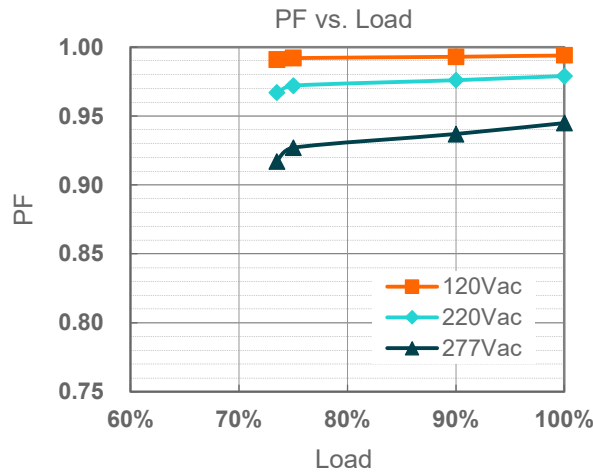

## Total Harmonic Distortion

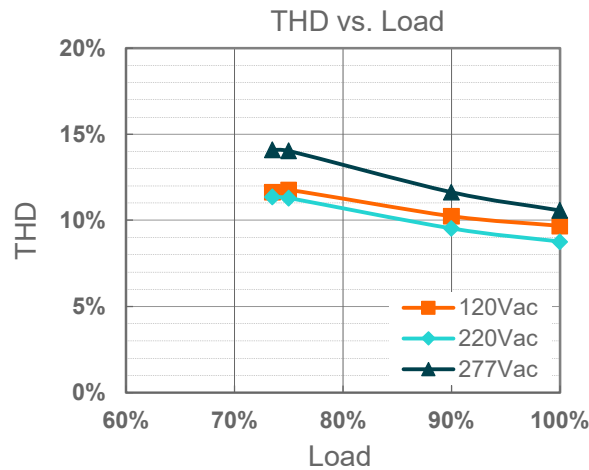

## Protection Functions

Parameter	Notes
Over Voltage Protection	Limits output voltage at no load and in case the normal voltage limit fails.
Short Circuit Protection	Auto Recovery. No damage shall occur when any output operating in a short circuit condition. The power supply shall be self-recovery when the fault condition is removed.
Over Temperature Protection	Decreases output current. Returning to normal after over temperature is removed.

## Dimming

### ● 1(0)-5V Dimming

The recommended implementation of the dimming control is provided below.



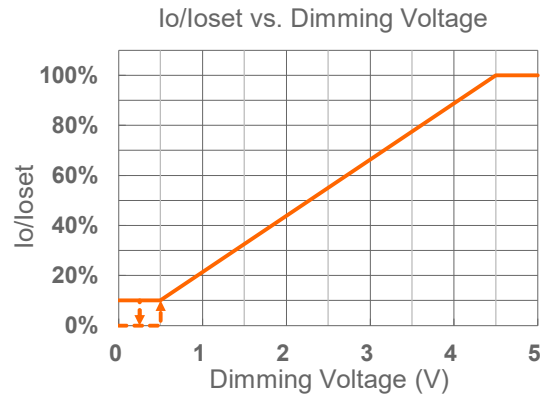
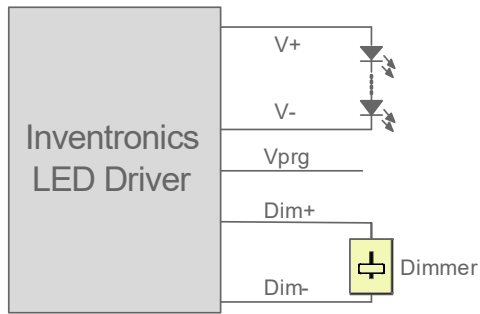

**Implementation 1: Positive logic**

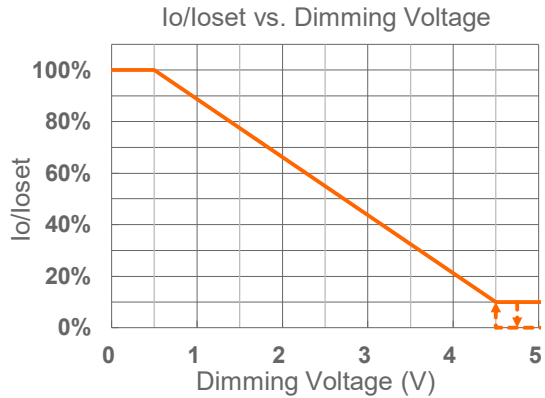
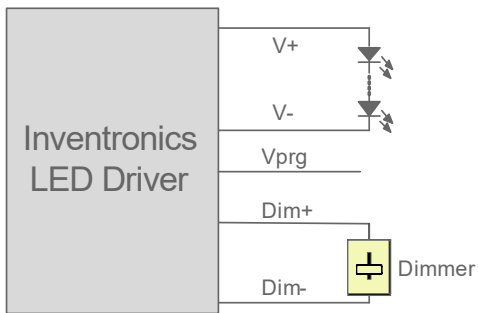

**Implementation 2: Negative logic**

**Notes:**

1. Do NOT connect Dim- to the output V- or V+, otherwise the driver will not work properly.
2. The dimmer can also be replaced by an active 1(0)-5V voltage source signal or passive components like zener.
3. Dimming mode can be set as 0-5V or 1-5V by Inventronics Multi Programmer.

● **1(0)-10V Dimming**

The recommended implementation of the dimming control is provided below.

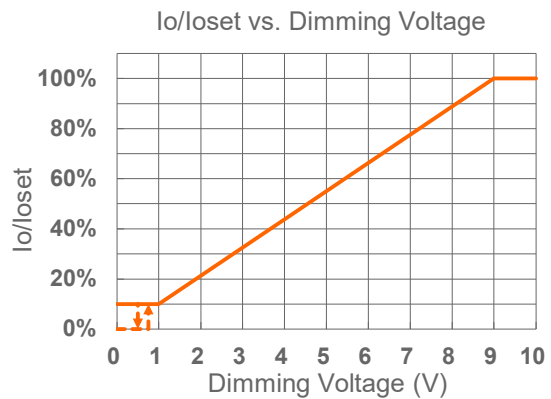
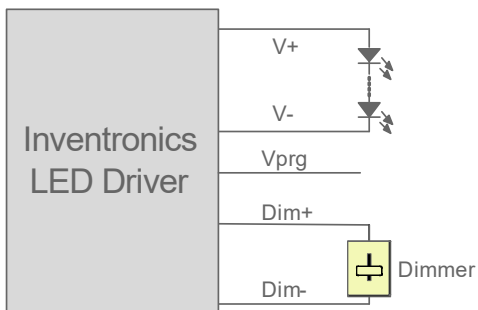

**Implementation 3: Positive logic (Default)**

**Notes:**

1. Do NOT connect Dim- to the output V- or V+, otherwise the driver will not work properly.
2. The dimmer can also be replaced by an active 1(0)-10V voltage source signal or passive components like zener.
3. Dimming mode can be set as 0-10V or 1-10V by Inventronics Multi Programmer, 1-10V is default.

● **10V PWM Dimming**

The recommended implementation of the dimming control is provided below.

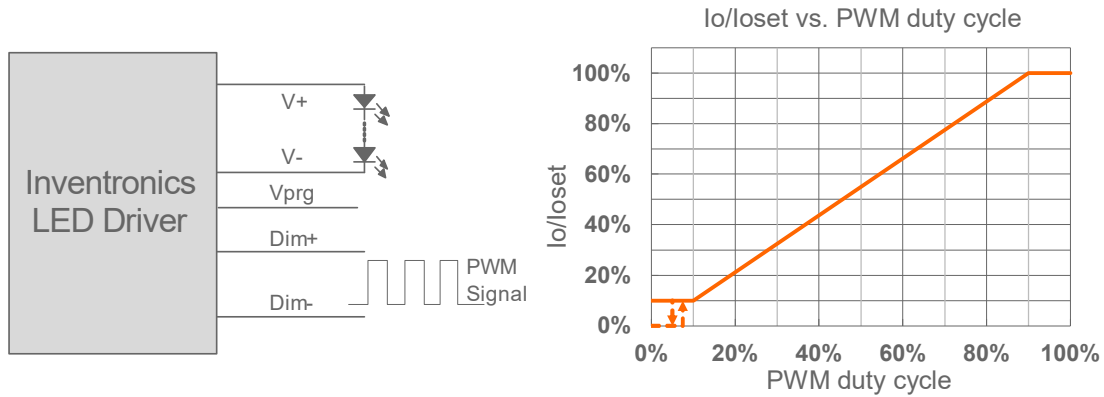

**Implementation 4: Positive logic**

**Notes:**

1. Do NOT connect Dim- to the output V- or V+, otherwise the driver will not work properly.

● **Adjustable Dimming Curve**

0-10V curve can be set as corresponding dimming voltage by Inventronics Multi Programmer. The recommended implementation of the dimming control is provided below.

When dimming voltage X point is set to be smaller than Y point, the dimming curve is positive logic.

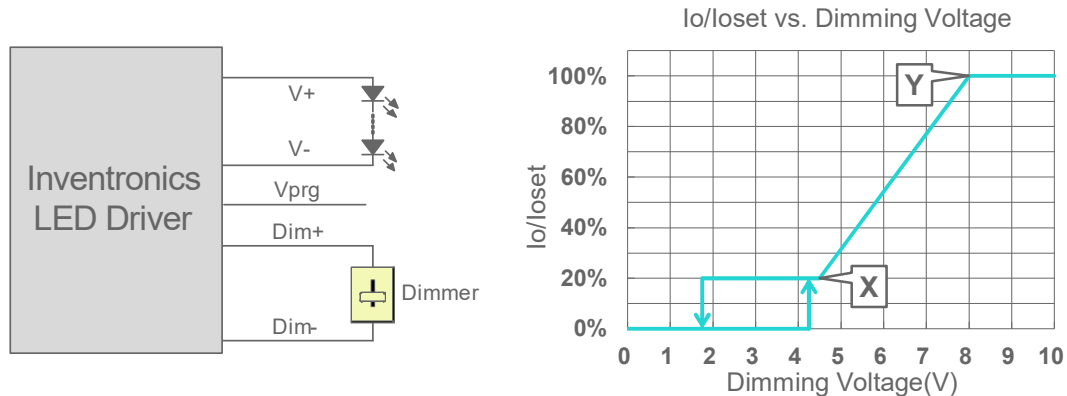

**Implementation 5: Positive logic**

When X point is set to be bigger than Y point, the dimming curve is negative logic, and dimming voltage > 5.5V, the driver will output maximum current. If Dim+ is open, the driver will output maximum current.

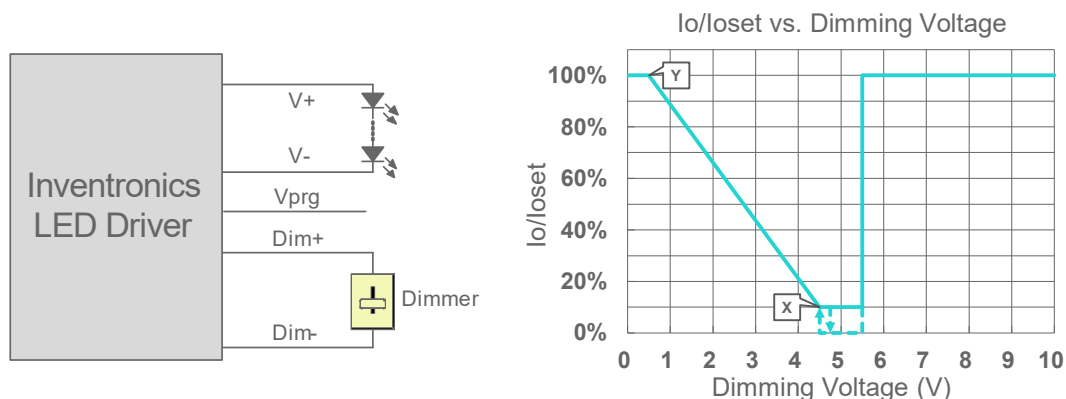

**Implementation 6: Negative logic**

**Notes:**

1. Do NOT connect Dim- to the output V- or V+, otherwise the driver will not work properly.
2. The dimmer can also be replaced by an active 0-10V voltage source signal or passive components like zener.
3. For best dimming accuracy, the difference between X point and Y point is advised not less than 4V.

● **Time Dimming**

Time dimming control includes 3 kinds of modes, they are Self Adapting-Midnight, Self Adapting-Percentage and Traditional Timer.

- **Self Adapting-Midnight:** Automatically adjusts the dimming curve based on the on-time of past two days (if difference <15 minutes), assuming that the center point of the dimming curve is midnight local time.
- **Self Adapting-Percentage:** Automatically adjusts the on-time of each step by a constant percentage = (actual on-time for the past 2 days if difference <15 min) / (programmed on-time from the dimming curve).
- **Traditional Timer:** Follows the programmed timing curve after power on with no changes.
- **Override Timer:** When the integrated timer is enabled, it is possible to override the dimming mode from 'Timer' into '1(0)-10V' by applying a voltage of 1(0)-10V between DIM+ and DIM-. Once a voltage  $\leq 10.5$  Vdc is detected the output current will coincide with the dimming voltage. By opening the DIM+ and DIM-circuitry, the LED driver will switch again to timer mode. During override, our product continues to count while the timer is being overridden. Once the override is removed, the output current returns to the same point in its timer cycle.

● **Output Lumen Compensation**

Output Lumen Compensation (OLC) may be used to maintain constant light output over the life of the LEDs by driving them at a reduced current when new, then gradually increasing the drive current over time to counteract LED lumen degradation.

● **End of Life**

End-of-Life (EOL) is providing a visual notification to a user that the LED module has reached the end of manufacturer-specified life and that the replacement is recommended. Once active, an indication is given at each power-up of the driver, which the driver indicates this through a lower light output during the first 1 minute before normal operation is continued.

## Programming Connection Diagram

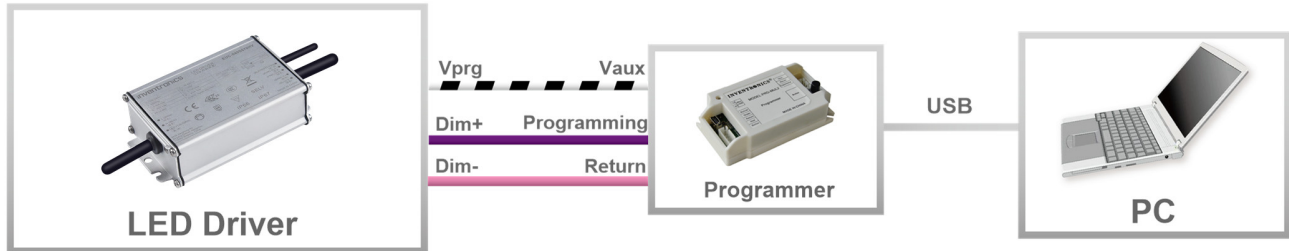

Note: The driver does not need to be powered on during the programming process.

- Please refer to [PRG-MUL2 \(Programmer\)](#) datasheet for details.

## Mechanical Outline

EUC-040SxxxHV

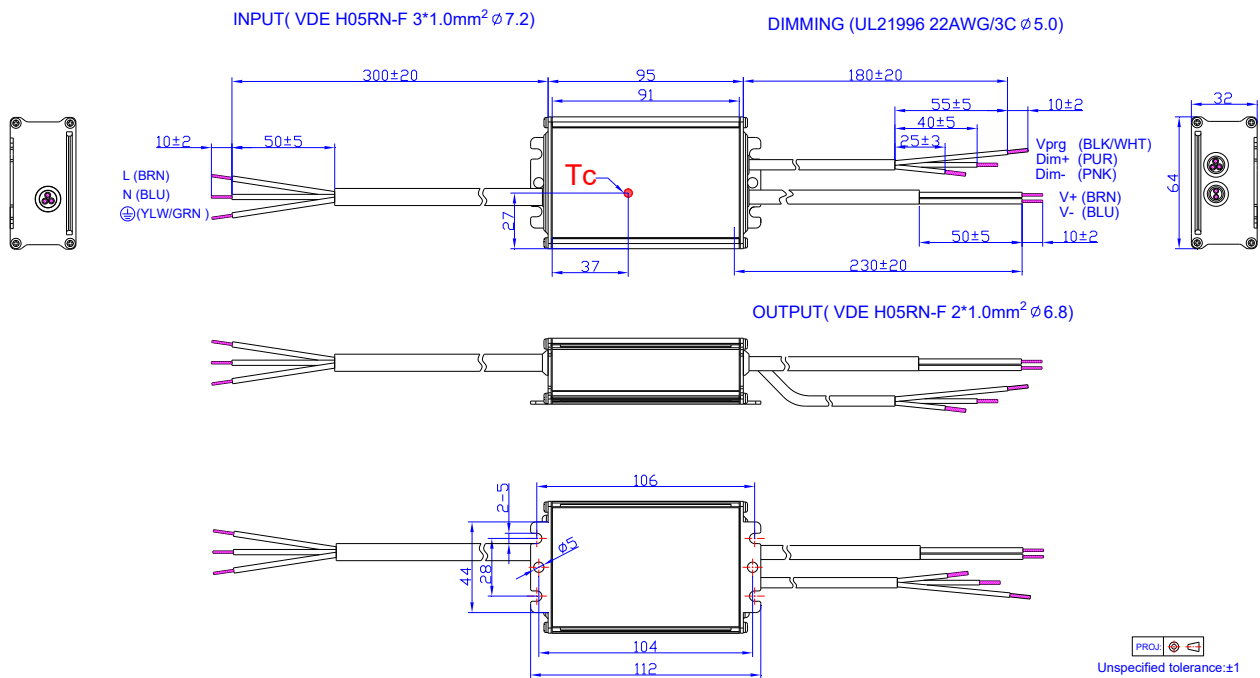

EUC-040SxxxHF

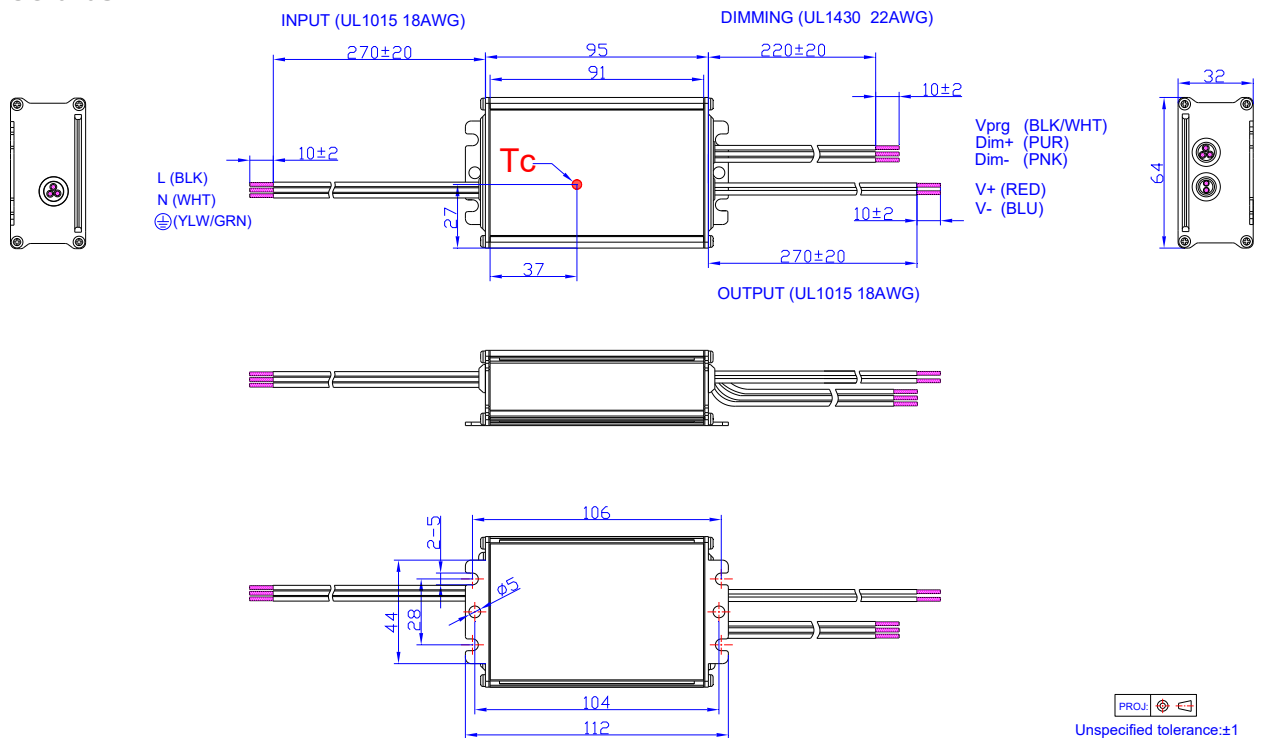

## RoHS Compliance

Our products comply with reference to RoHS Directive (EU) 2015/863 amending 2011/65/EU, calling for the elimination of lead and other hazardous substances from electronic products.

## Revision History

Change Date	Rev.	Description of Change		
		Item	From	To
2024-11-07	A	Datasheet Release	/	/