

Features

- Ultra low supply current : 4μA
- Low ripple and low noise
- High efficiency up to 95%
- Fixed output voltage: 2.7V, 3.0V, 3.3V, 3.7V, 5.0V
- High output voltage accuracy: ±2%
- Output current:
Up to 200mA @ $0.6 \times V_{OUT} \leq V_{IN} \leq V_{OUT}$
- Low shutdown current: 0.1μA (Typ.)
- Package types: 3-pin SOT89, 3-pin SOT23 and 5-pin SOT23

Applications

- Palmtops/PDAs
- Portable communicators/Smartphones
- Cameras/Camcorders
- Battery-powered equipment: Remote Control, Wireless Mouse, blood glucose meter, electric clipper and thermometer

General Description

The HT77xxFA series is a set of synchronous step-up DC/DC converters with high efficiency. The series devices have the advantage of extremely low start-up voltage, which is suitable for 1-cell Alkaline battery applications. Being manufactured using CMOS technology ensures ultra low supply current to extend power endurance for portable products. The devices require only three external components to provide a fixed output voltage of 2.7V, 3.0V, 3.3V, 3.7V or 5.0V.

In order to save PCB layout area, these devices are using synchronous topology integrated schottky diode, and also using 3-pin SOT89, 3-pin SOT23 and 5-pin SOT23 packages. For 5-pin SOT23 package type, it also includes an internal chip enable function to reduce power consumption in the shutdown mode.

Selection Table

Part No.	Output Voltage	Packages	Markings
HT7727FA	2.7V	SOT89 SOT23 SOT23-5	HT7xxFA marking for SOT89 type xxFA marking for SOT23 and SOT23-5 types
HT7730FA	3.0V		
HT7733FA	3.3V		
HT7737FA	3.7V		
HT7750FA	5.0V		

Note: “xx” stands for output voltages.

Typical Application Circuits

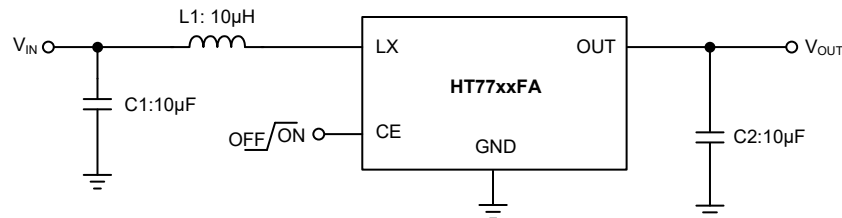

Block Diagram

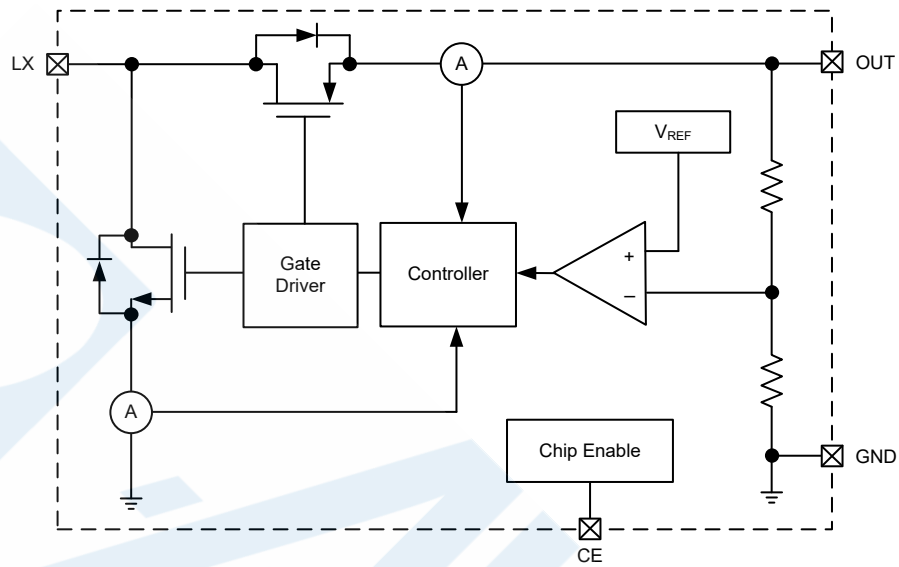

Pin Assignment

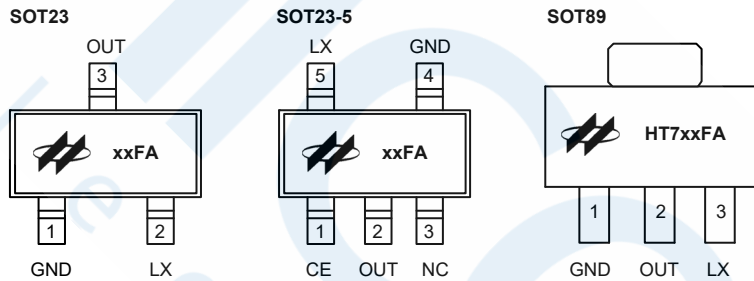

Pin Description

Pin No.			Pin Name	Pin Description
SOT89	SOT23	SOT23-5		
—	—	1	CE	Chip enable pin, high active.
2	3	2	OUT	Output voltage pin
—	—	3	NC	No connection
1	1	4	GND	Ground pin
3	2	5	LX	Switching pin

Absolute Maximum Ratings

Parameter	Value	Unit	
OUT	-0.3 to +6.6	V	
LX and CE	-0.3 to +6.6	V	
Maximum Junction Temperature	+150	°C	
Storage Temperature Range	-65 to +150	°C	
Lead Temperature (Soldering 10sec)	+260	°C	
ESD Susceptibility	Human Body Mode	8000	V
	Machine Mode	500	V
Junction-to-Ambient Thermal Resistance, θ_{JA}	SOT89	200	°C/W
	SOT23	250	
	SOT23-5	250	
Power Dissipation, P_D	SOT89	0.625	W
	SOT23	0.5	
	SOT23-5	0.5	

Recommended Operating Ratings

Parameter	Value	Unit
V_{IN}	0.85 to 6.0	V
Operating Temperature Range	-40 to +85	°C

Note that Absolute Maximum Ratings indicate limitations beyond which damage to the device may occur. Recommended Operating Ratings indicate conditions for which the device is intended to be functional, but do not guarantee specified performance limits.

Electrical Characteristics

$V_{IN}=V_{OUT}\times 0.6$, $I_{OUT}=10\text{mA}$ and $T_a=+25^\circ\text{C}$, unless otherwise specified

Symbol	Parameter	Test Condition	Min.	Typ.	Max.	Unit
V_{IN}	Input Voltage	—	—	—	6	V
ΔV_{OUT}	Output Voltage Accuracy	$L=10\mu\text{H}$, $C_{OUT}=10\mu\text{F}$	-2	—	+2	%
V_{START}	Startup Voltage(Fig.1)	V_{IN} : 0 to 2V, $I_{OUT}=1\text{mA}$, $V_{OUT}=V_{OUT_TARGET}$	—	0.85	0.90	V
V_{HOLD}	Hold on Voltage (Fig.1)	V_{IN} : 2 to 0V, $I_{OUT}=1\text{mA}$, V_{OUT} drops 5%	—	0.25	0.70	V
I_{DD}	Supply Current (Fig.2)	Measured at OUT pin, $V_{OUT}=V_{OUT_target}\times 106\%$	—	4.0	—	μA
I_{IN}	Un-load Supply Current (Fig.1)	$V_{IN}=V_{OUT}\times 0.6$, $I_{OUT}=0\text{mA}$, $L=10\mu\text{H}$, $C_{OUT}=10\mu\text{F}$, Measured at V_{IN}	—	6	20	μA
I_{SHDN}	Shutdown Current	CE=GND	—	0.1	—	μA
V_{IH}	CE High Threshold	—	1.5	—	—	V
V_{IL}	CE Low Threshold	—	—	—	0.4	V
I_{LEAK}	LX Leakage Current	—	—	0.05	—	μA

Note: Absolute maximum ratings indicate limits beyond which damage to the device may occur. Operating Ratings indicate conditions for which the device is intended to be functional, but do not guarantee specific performance limits. The guaranteed specifications apply only for the test conditions listed.

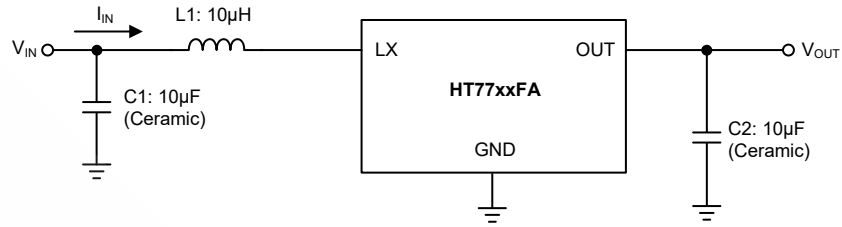

Fig.1

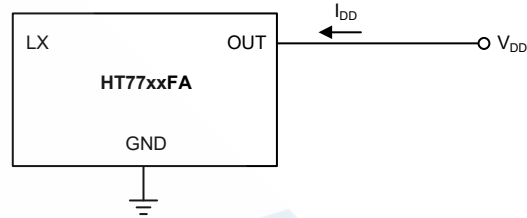
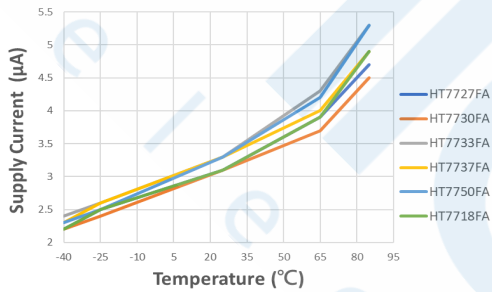

Fig.2

Typical Performance Characteristics

$V_{IN}=0.6 \times V_{OUT}$, $C_{IN}=10\mu F$, $C_{OUT}=10\mu F$, $L=10\mu H$ (coil), $T_a=25^\circ C$, unless otherwise specified

Supply Current VS Temperature



Un-load Supply Current

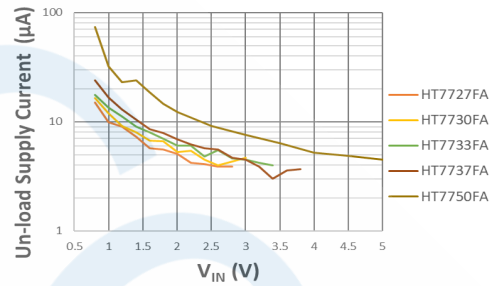

HT7727FA Efficiency

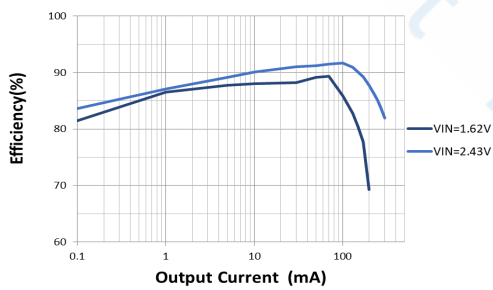

HT7727FA Load regulation

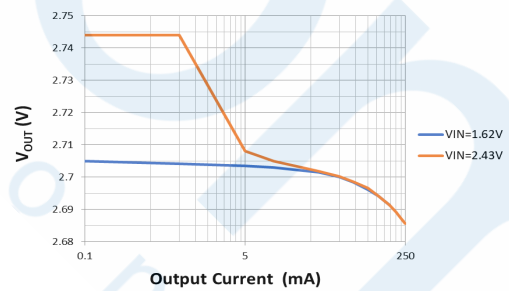

$V_{IN}=0.6 \times V_{OUT}$, $C_{IN}=10\mu F$, $C_{OUT}=10\mu F$, $L=10\mu H$ (coil), $T_a=25^\circ C$, unless otherwise specified

HT7727FA Start Up & Hold On

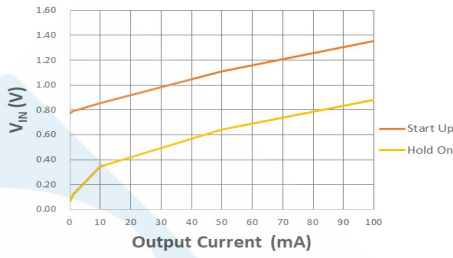

HT7727FA Ripple @L=10μH Cout=10μF

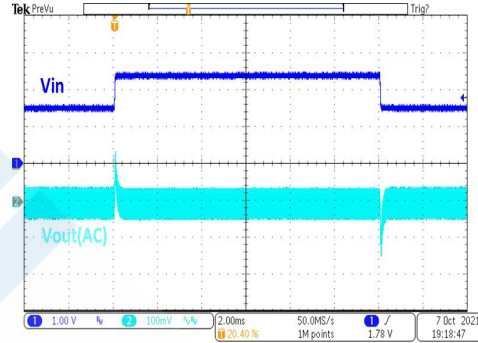
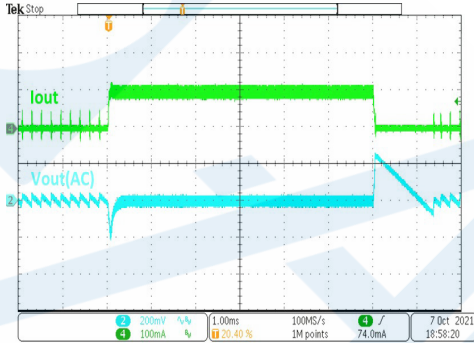
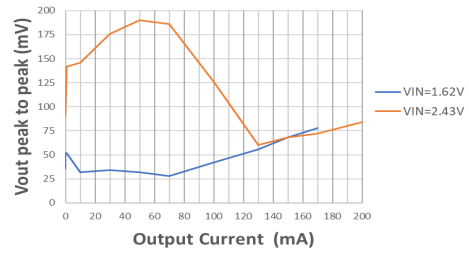

HT7727FA Load Transient

($L=10\mu H$, $C_{IN}=C_{OUT}=10\mu F$, $I_{OUT}=1mA\sim 100mA$)

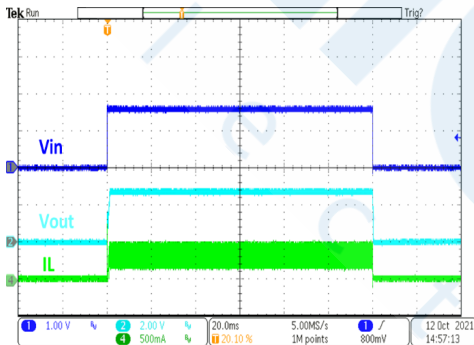

HT7727FA Line Transien

($V_{IN}=1.62V\sim 2.43V$, $I_{OUT}=150mA$)

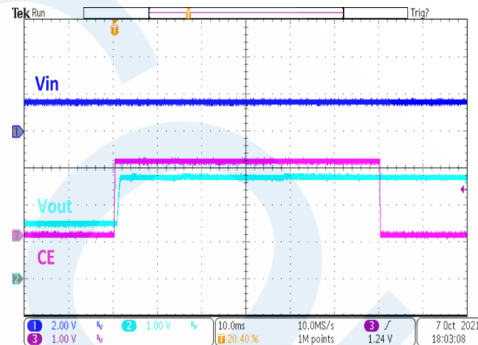

HT7727FA Power On/Off

($V_{IN}=1.62V$, $I_{OUT}=150mA$)

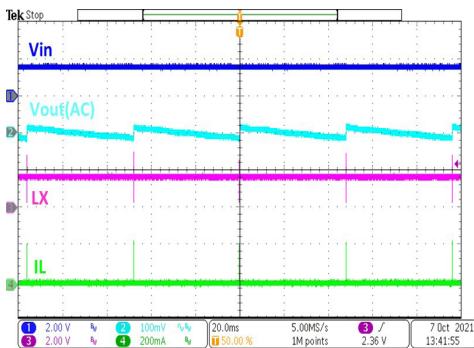

HT7727FA Chip Enable/Disable

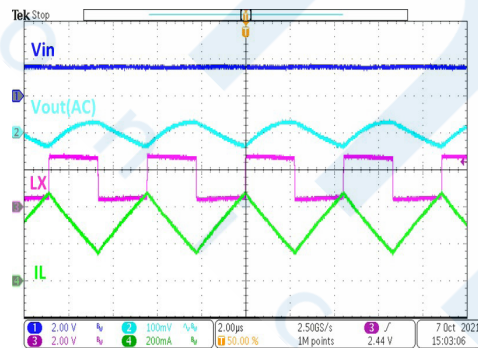

HT7727FA Operation ($I_{OUT}=0mA$)

HT7727FA Operation ($I_{OUT}=150mA$)

$V_{IN}=0.6 \times V_{OUT}$, $C_{IN}=10\mu F$, $C_{OUT}=10\mu F$, $L=10\mu H$ (coil), $T_a=25^\circ C$, unless otherwise specified

HT7730FA Efficiency

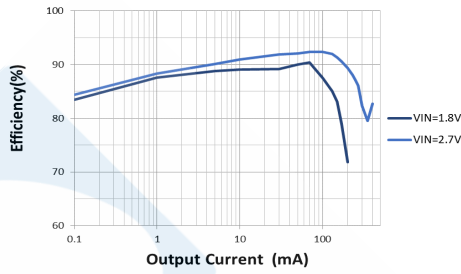

HT7730FA Load regulation

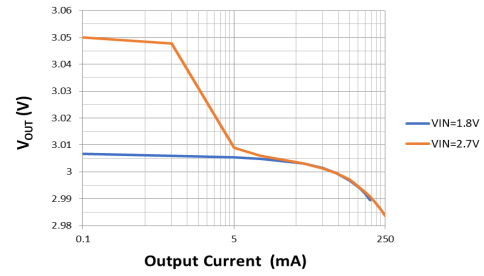

HT7730FA Start Up & Hold On

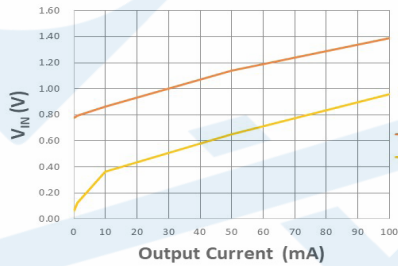

HT7730FA Ripple @L=10μH Cout=10μF

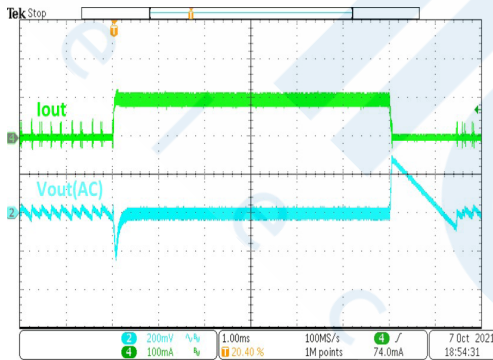
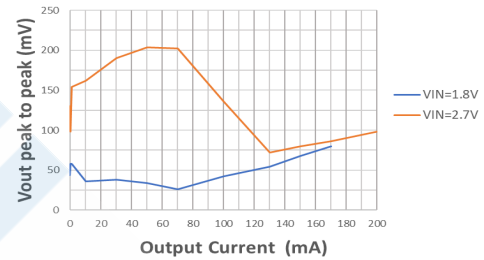

HT7730FA Load Transient
($L=10\mu H$, $C_{IN}=C_{OUT}=10\mu F$, $I_{OUT}=1mA\sim 100mA$)

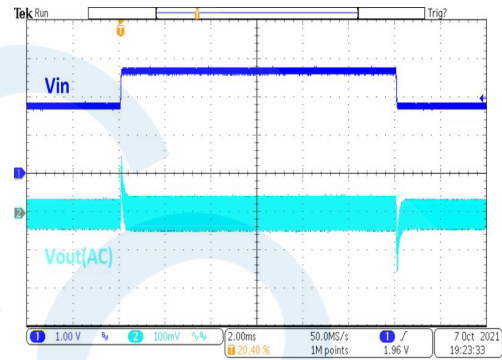

HT7730FA Line Transient
($V_{IN}=1.8V\sim 2.7V$, $I_{OUT}=150mA$)

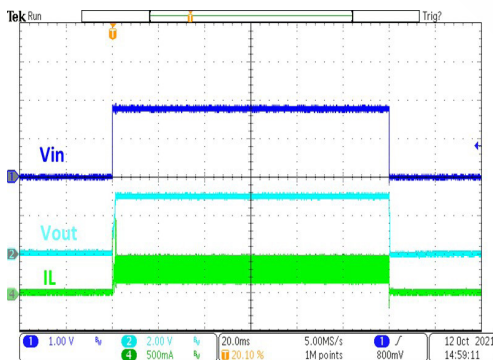

HT7730FA Power On/Off
($V_{IN}=1.8V$, $I_{OUT}=150mA$)

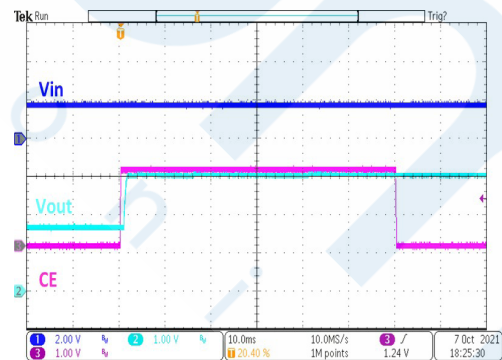

HT7730FA Chip Enable/Disable

$V_{IN}=0.6 \times V_{OUT}$, $C_{IN}=10\mu F$, $C_{OUT}=10\mu F$, $L=10\mu H$ (coil), $T_a=25^\circ C$, unless otherwise specified

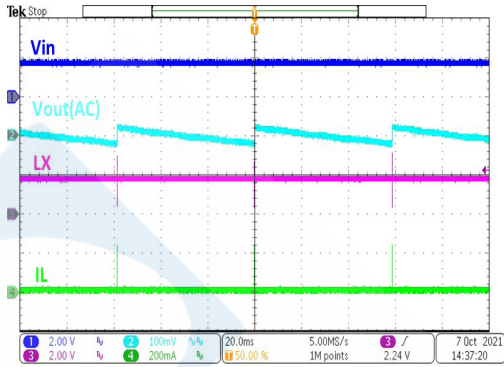

HT7730FA Operation ($I_{OUT}=0mA$)

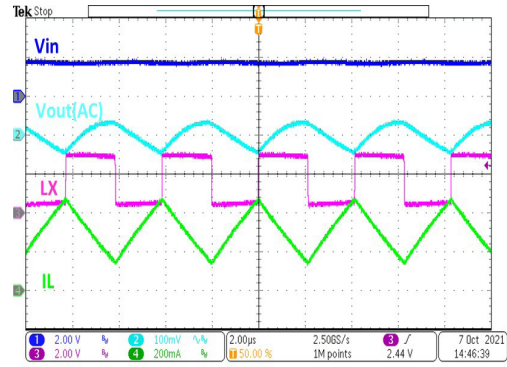

HT7730FA Operation ($I_{OUT}=150mA$)

HT7733FA Efficiency

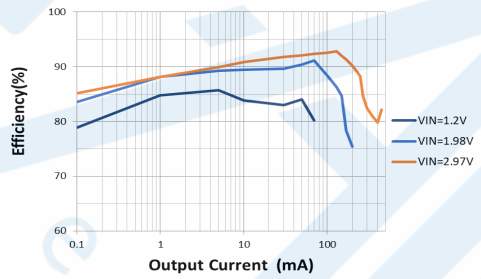

HT7733FA Load regulation

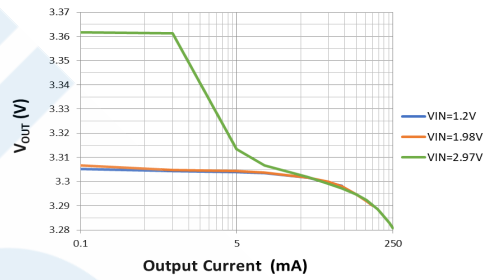

HT7733FA Start Up & Hold On

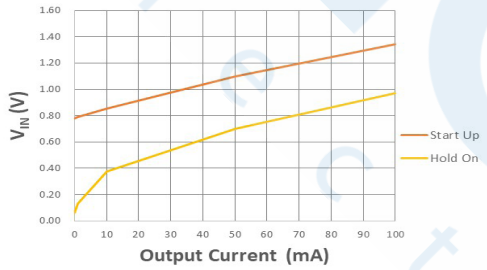

HT7733FA Ripple @L=10µH Cout=10µF

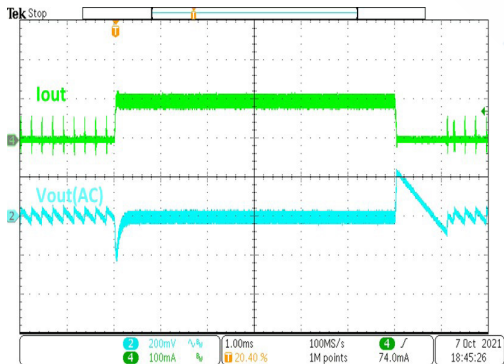
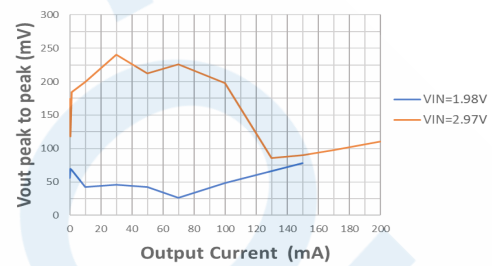

HT7733FA Load Transient
($L=10\mu H$, $C_{IN}=C_{OUT}=10\mu F$, $I_{OUT}=1mA\sim 100mA$)

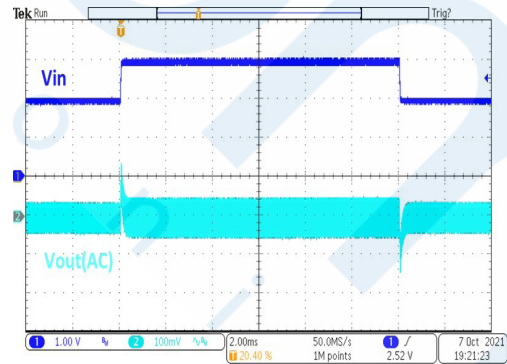

HT7733FA Line Transient
($V_{IN}=1.98V\sim 2.97V$, $I_{OUT}=150mA$)

$V_{IN}=0.6 \times V_{OUT}$, $C_{IN}=10\mu F$, $C_{OUT}=10\mu F$, $L=10\mu H$ (coil), $T_a=25^\circ C$, unless otherwise specified

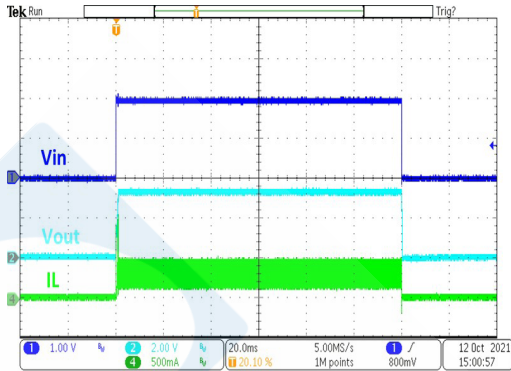

HT7733FA Power On/Off
($V_{IN}=1.98V$, $I_{OUT}=150mA$)

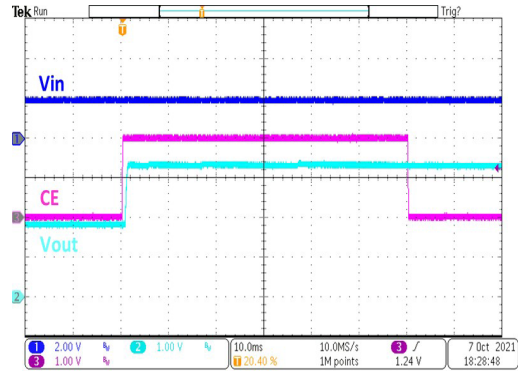

HT7733FA Chip Enable/Disable

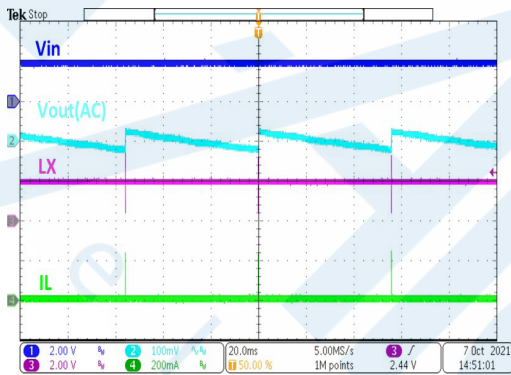

HT7733FA Operation ($I_{out}=0mA$)

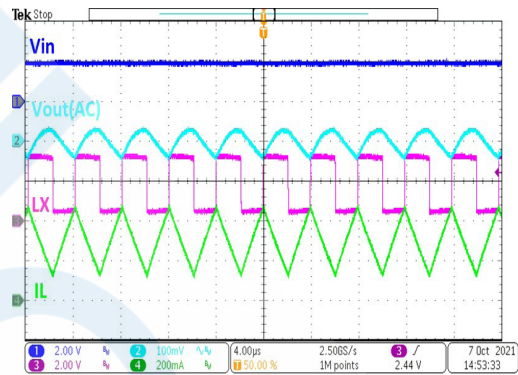

HT7733FA Operation ($I_{out}=150mA$)

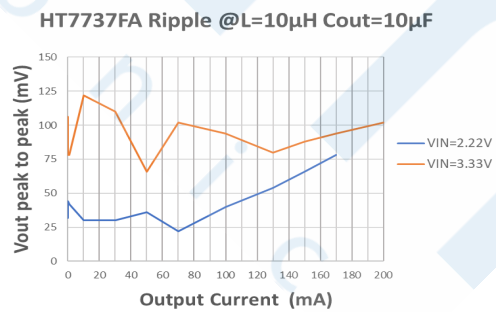
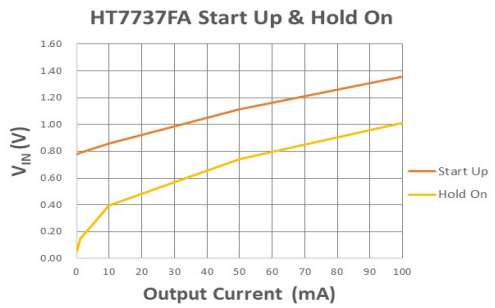
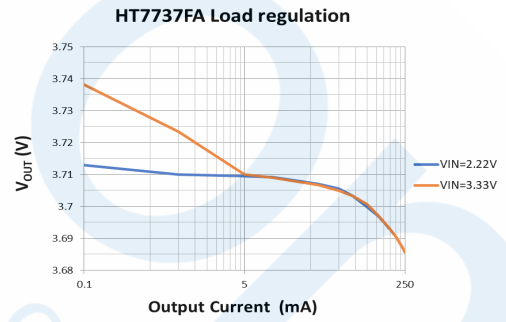
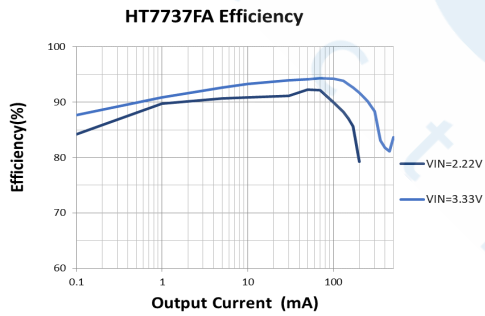

$V_{IN}=0.6 \times V_{OUT}$, $C_{IN}=10\mu F$, $C_{OUT}=10\mu F$, $L=10\mu H$ (coil), $T_a=25^\circ C$, unless otherwise specified

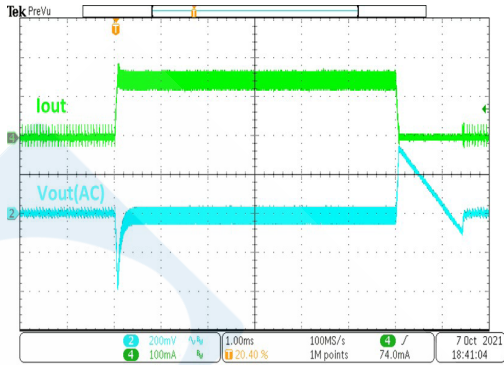

HT7737FA Load Transient
($L=10\mu H$, $C_{IN}=C_{OUT}=10\mu F$, $I_{OUT}=1mA\sim 150mA$)

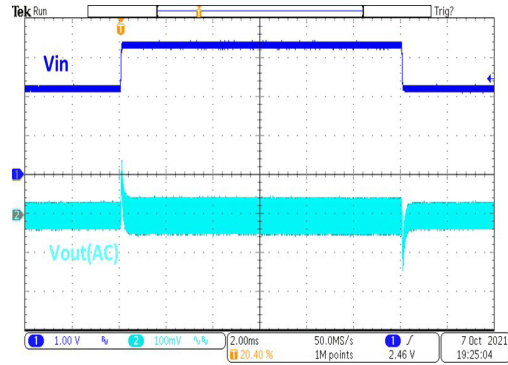

HT7737FA Line Transient
($V_{IN}=2.22V\sim 3.33V$, $I_{OUT}=150mA$)

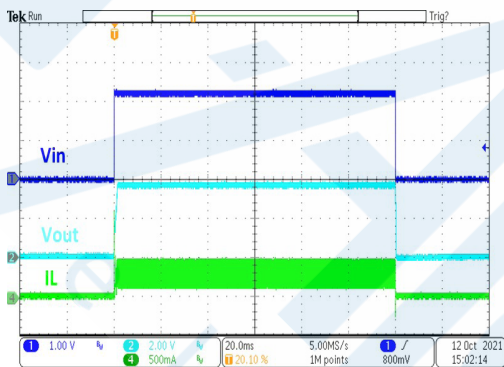

HT7737FA Power On/Off
($V_{IN}=2.22V$, $I_{OUT}=150mA$)

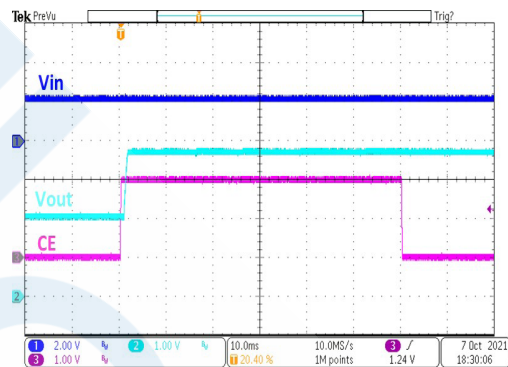

HT7737FA Chip Enable/Disable

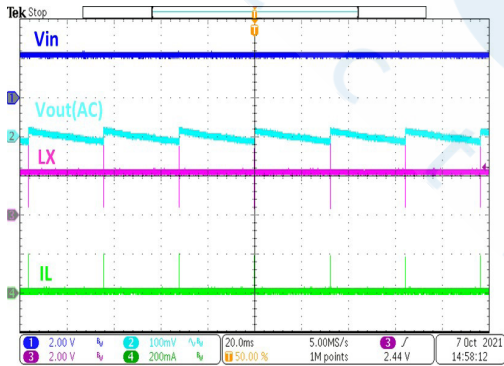

HT7737FA Operation ($I_{OUT}=0mA$)

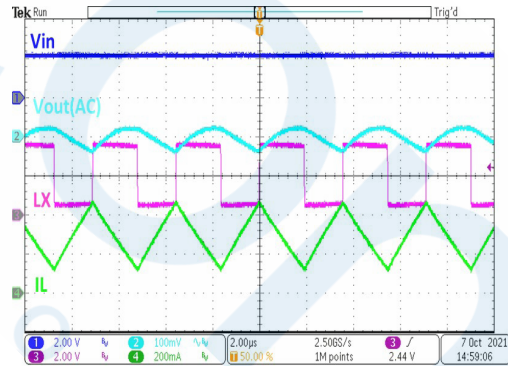

HT7737FA Operation ($I_{OUT}=150mA$)

$V_{IN}=0.6 \times V_{OUT}$, $C_{IN}=10\mu F$, $C_{OUT}=10\mu F$, $L=10\mu H$ (coil), $T_a=25^\circ C$, unless otherwise specified

HT7750FA Efficiency

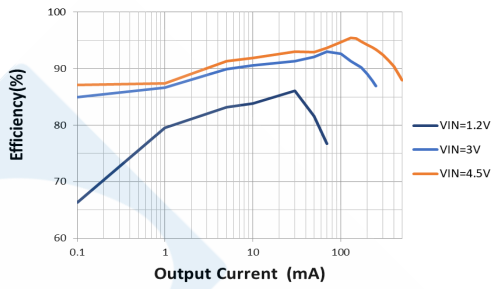

HT7750FA Load regulation

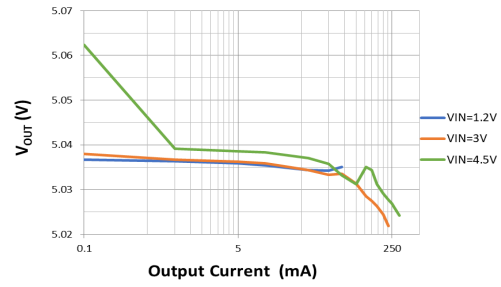

HT7750FA Start Up & Hold On

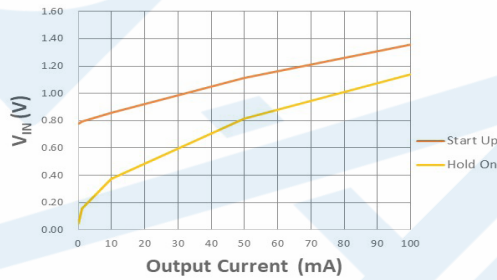

HT7750FA Ripple @L=10μH Cout=10μF

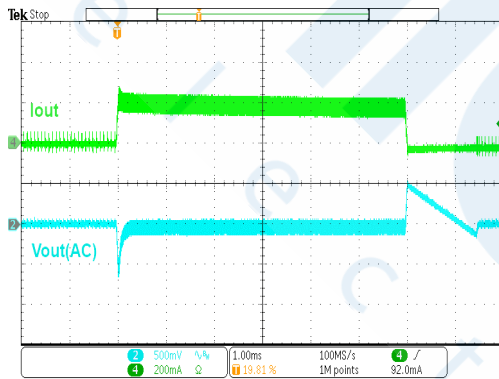
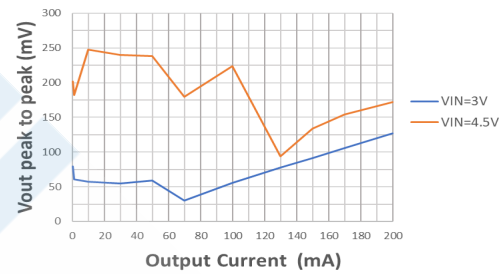

HT7750FA Load Transient
($L=10\mu H$, $C_{IN}=C_{OUT}=10\mu F$, $I_{OUT}=1mA\sim 200mA$)

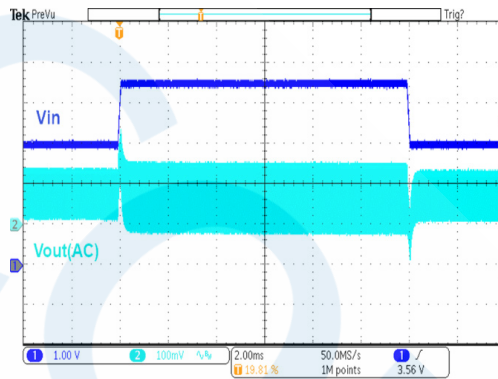

HT7750FA Line Transient
($V_{IN}=3V\sim 4.5V$, $I_{OUT}=200mA$)

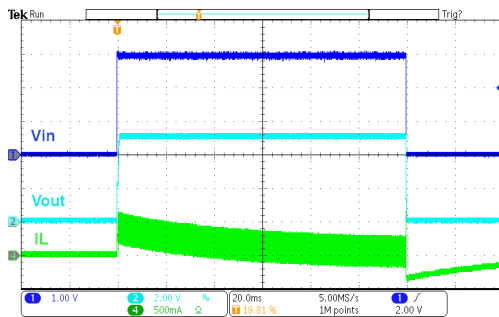

HT7750FA Power On/Off
($V_{IN}=3V$, $I_{OUT}=200mA$)

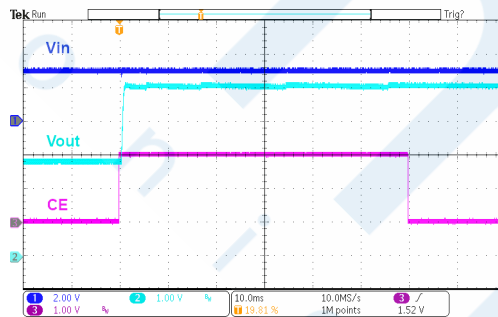

HT7750FA Chip Enable/Disable

$V_{IN}=0.6 \times V_{OUT}$, $C_{IN}=10\mu F$, $C_{OUT}=10\mu F$, $L=10\mu H$ (coil), $T_a=25^\circ C$, unless otherwise specified

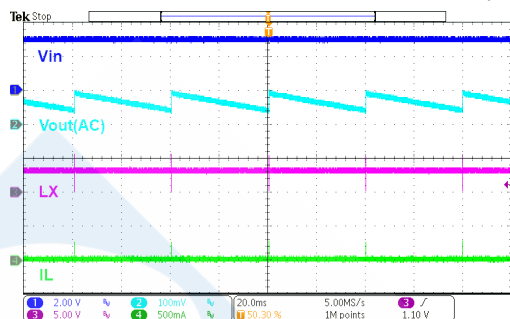

HT7750FA Operation ($I_{OUT}=0mA$)

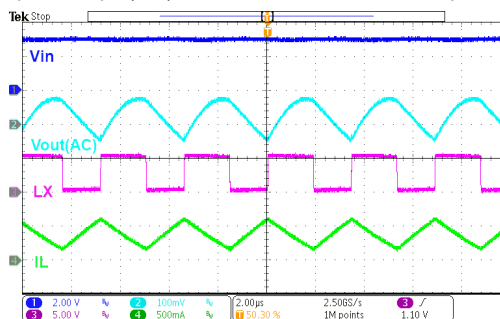

HT7750FA Operation ($I_{OUT}=200mA$)

Functional Description

The HT77xxFA series is a set of synchronous step-up converters with a low-quiescent current of $4\mu A$ (typ.). The devices use pulse frequency modulation (PFM) controller scheme. According to the input voltage and output voltage, the output driving ability is shown as below curve. The devices have excellent load regulation performance. The devices are able to start-up with a low input voltage of 0.85V, and keep working until the input voltage is lower than the hold-on voltage of 0.25V.

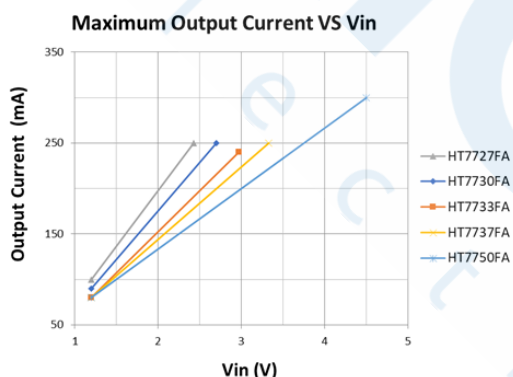

Low Voltage Start-up

The devices have a very low start up voltage which is down to 0.85V. When the power is first applied, the synchronous switch will be initially off but the energy will be transferred to the output through its intrinsic body diode.

The devices have a very low start up voltage which is down to 0.85V. When the power is first applied, the synchronous switch will be initially off but the energy will be transferred to the output through its intrinsic body diode.

Shutdown

During normal device operation, the CE pin should be either high or connected to the V_{OUT} . When the devices are in the shutdown mode, that is when the CE pin is pulled low, the internal circuitry will be switched off. During the shutdown mode, the PMOS power transistor will be switched off. However, input energy will be transferred to the output through PMOS intrinsic body diode, so the output voltage is almost equal to V_{IN} .

Power on

When the output voltage rises up to the typical value of 0.85V, the devices will be in the soft-start within 1.5ms. In this way, the soft-start function reduces the input inrush current and the output voltage overshoot. If the input voltage rise time exceeds 1.5ms at light loading, it will cause an overshoot about 1.1 times of an output voltage target. It is recommended that the rise time of the input voltage should be less than 1.5ms to reduce light loading overshoot.

Component Selection

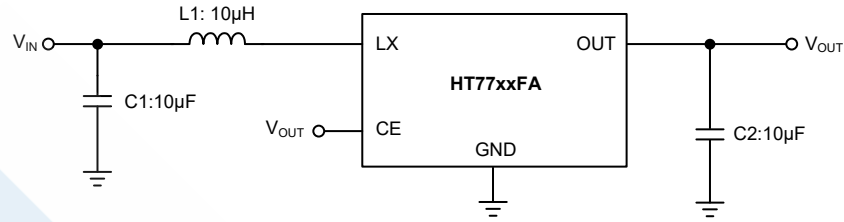

Reference	Value	Description	Part Number	Manufacturer
C1	10µF	MLCC, 10V, X5R, 0805	LMK212B7106KG-TD	Taiyo Yuden
C2	10µF	MLCC, 10V, X5R, 0805	LMK212B7106KG-TD	Taiyo Yuden
L1	10µH	Coil, 5.8mm×5.2mm×4.5mm	GS54-100K	Gang Song

Recommended Component Values

Power Inductor

It is recommended to use 10µH to 47µH inductance, Inductance above 47µH is not recommended, and 10µH inductance remains low output ripple voltage in most applications. It is suggested to choose a lower DCR with a typical value less than 1Ω to reduce the efficiency loss. Otherwise, the chosen inductor saturation current should be greater than its peak current with a typical value of 1A or higher in applications.

Input Capacitor

A low ESR ceramic capacitor, C_{IN}, is needed between the VIN and GND pins. Use ceramic capacitors with X5R or X7R dielectrics for their low ESRs and small temperature coefficients. For most applications, a 10µF capacitor will be a proper selection.

Output Capacitor

The output capacitor, C_{OUT}, selection is determined by the maximum allowable output voltage ripple. Use ceramic capacitors with X5R or X7R dielectrics. Capacitors in the range of 10µF to 100µF are a good starting point. It is usually suggested to use a 10µF capacitor in most applications. If the load current has the requirement of drastic changes, a 22µF to 100µF capacitor and a 10µH inductance are recommended to be used to maintain a good output voltage stability characteristic. As shown in Fig.3 and Fig.4.

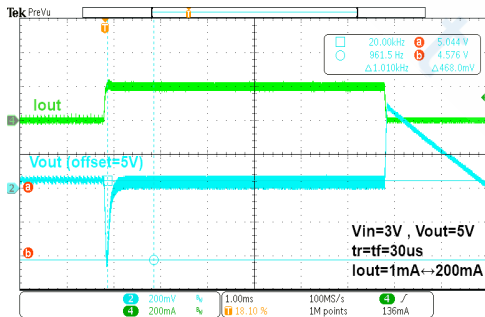

Fig. 3

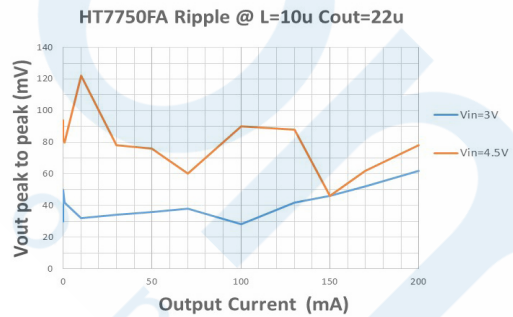
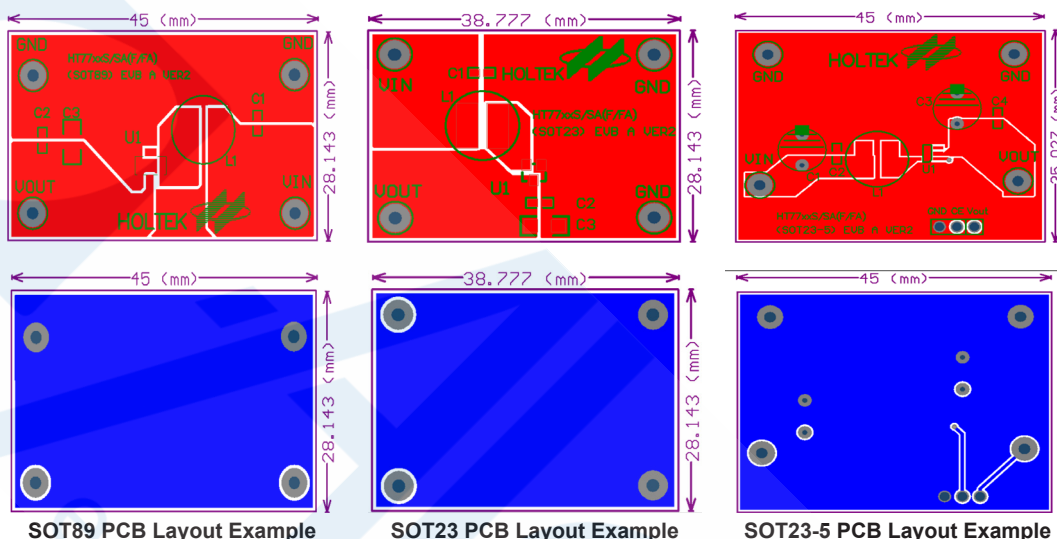

Fig. 4

PCB Layout Suggestion

To reduce problems with conducted noise, there are some important points to note on the PCB layout.

1. The input bypass capacitor must be placed close to the inductor.
2. The inductor and output capacitor traces should be as short as possible to reduce the conducted and radiated noise and increase the overall efficiency.
3. The VIN, VOUT and GND traces should be as wide as possible.



Thermal Consideration

The maximum power dissipation depends upon the thermal resistance of the IC package, PCB layout, rate of surrounding airflow and difference between the junction and ambient temperature. The maximum power dissipation can be calculated by the following formula:

$$P_{D(MAX)} = (T_{J(MAX)} - T_a) / \theta_{JA} \quad (W)$$

Where $T_{J(MAX)}$ is the maximum junction temperature, T_a is the ambient temperature and θ_{JA} is the junction to ambient thermal resistance.

For maximum operating rating conditions, the maximum junction temperature is 150°C. However, it's recommended that the maximum junction temperature does not exceed 125°C during normal operation to maintain high reliability. The de-rating curve of the maximum power dissipation is show below:

$$P_{D(MAX)} = (150^\circ\text{C} - 25^\circ\text{C}) / (250^\circ\text{C}/\text{W}) = 0.5\text{W} \quad (\text{SOT23-5})$$

For a fixed $T_{J(MAX)}$ of 150°C, the maximum power dissipation depends upon the operating ambient temperature and the package's thermal resistance, θ_{JA} . The de-rating curve below shows the effect of rising ambient temperature on the maximum recommended power dissipation.

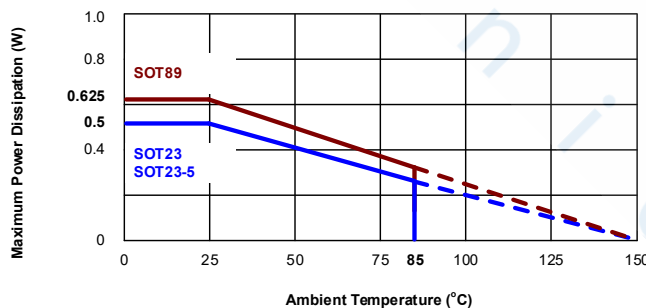

Application Circuits

Without CE Pin Application Circuit

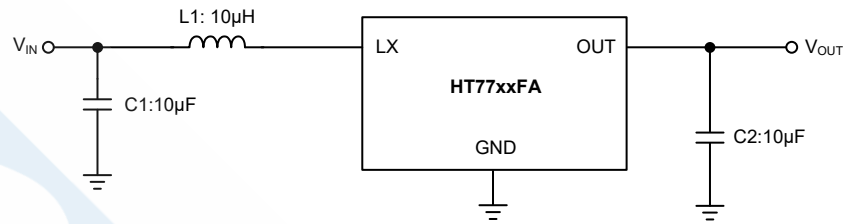

With CE Pin Application Circuit

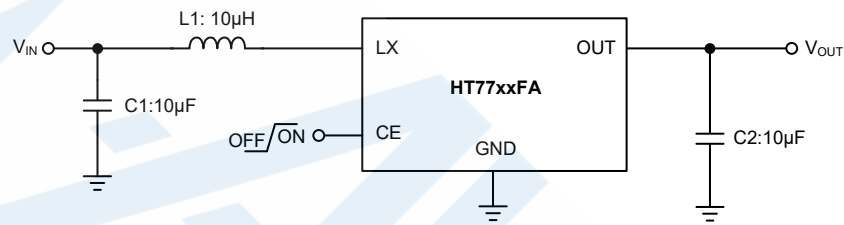

Note: 1. When CE='0', the device internal circuits such as the bandgap reference, gain block and all feedback and control circuitry will be switched off.

2. When CE='0', the output voltage, V_{OUT} , is almost equal to V_{IN} .

3. If the CE pin is not used, it should be externally connected to the OUT pin.

Package Information

Note that the package information provided here is for consultation purposes only. As this information may be updated at regular intervals users are reminded to consult the [Holtek website](#) for the latest version of the [Package/ Carton Information](#).

Additional supplementary information with regard to packaging is listed below. Click on the relevant section to be transferred to the relevant website page.

- [Package Information \(include Outline Dimensions, Product Tape and Reel Specifications\)](#)
- [Packing Materials Information](#)
- [Carton information](#)

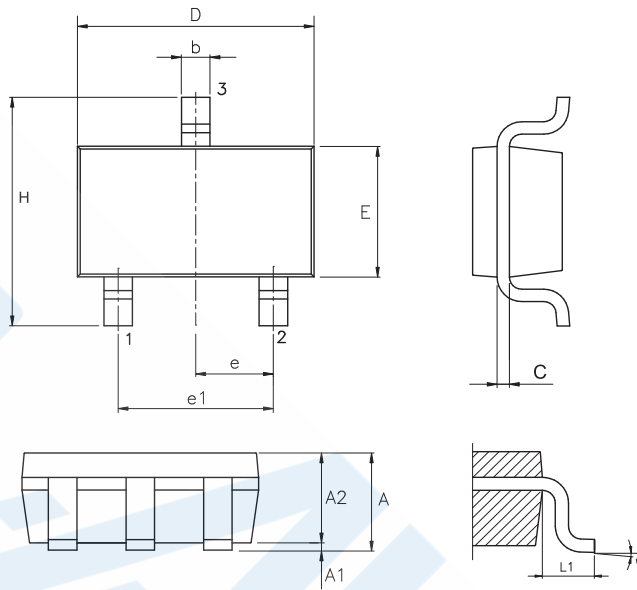
3-pin SOT23 Outline Dimensions

Symbol	Dimensions in inch		
	Min.	Nom.	Max.
A	—	—	0.057
A1	—	—	0.006
A2	0.035	0.045	0.051
b	0.012	—	0.020
C	0.003	—	0.009
D	—	0.114 BSC	—
E	—	0.063 BSC	—
e	—	0.037 BSC	—
e1	—	0.075 BSC	—
H	—	0.110 BSC	—
L1	—	0.024 BSC	—
θ	0°	—	8°

Symbol	Dimensions in mm		
	Min.	Nom.	Max.
A	—	—	1.45
A1	—	—	0.15
A2	0.90	1.15	1.30
b	0.30	—	0.50
C	0.08	—	0.22
D	—	2.90 BSC	—
E	—	1.60 BSC	—
e	—	0.95 BSC	—
e1	—	1.90 BSC	—
H	—	2.80 BSC	—
L1	—	0.60 BSC	—
θ	0°	—	8°

3-pin SOT89 Outline Dimensions

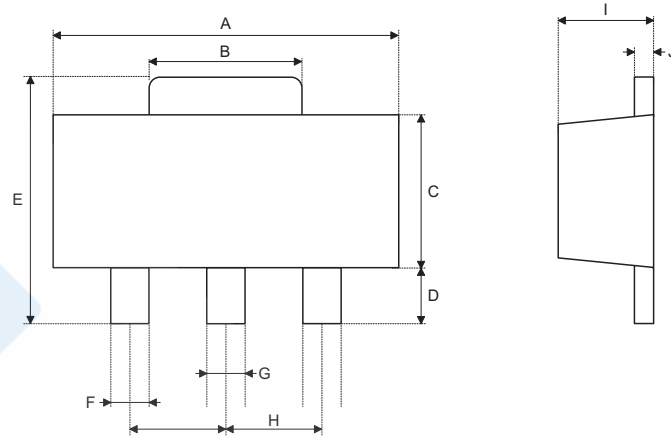

Symbol	Dimensions in inch		
	Min.	Nom.	Max.
A	0.173	—	0.185
B	0.053	—	0.072
C	0.090	—	0.106
D	0.031	—	0.047
E	0.155	—	0.173
F	0.014	—	0.019
G	0.017	—	0.022
H	—	0.059 BSC	—
I	0.055	—	0.063
J	0.014	—	0.017

Symbol	Dimensions in mm		
	Min.	Nom.	Max.
A	4.40	—	4.70
B	1.35	—	1.83
C	2.29	—	2.70
D	0.80	—	1.20
E	3.94	—	4.40
F	0.36	—	0.48
G	0.44	—	0.56
H	—	1.50 BSC	—
I	1.40	—	1.60
J	0.35	—	0.44

5-pin SOT23 Outline Dimensions

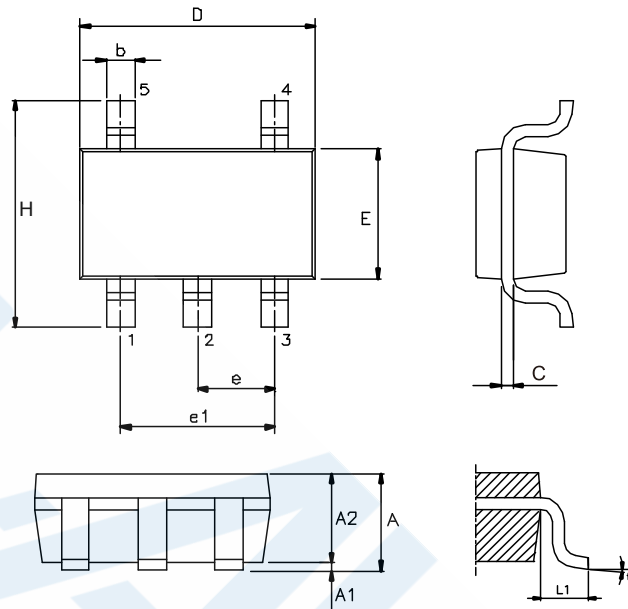

Symbol	Dimensions in inch		
	Min.	Nom.	Max.
A	—	—	0.057
A1	—	—	0.006
A2	0.035	0.045	0.051
b	0.012	—	0.020
C	0.003	—	0.009
D	—	0.114 BSC	—
E	—	0.063 BSC	—
e	—	0.037 BSC	—
e1	—	0.075 BSC	—
H	—	0.110 BSC	—
L1	—	0.024 BSC	—
θ	0°	—	8°

Symbol	Dimensions in mm		
	Min.	Nom.	Max.
A	—	—	1.45
A1	—	—	0.15
A2	0.90	1.15	1.30
b	0.30	—	0.50
C	0.08	—	0.22
D	—	2.90 BSC	—
E	—	1.60 BSC	—
e	—	0.95 BSC	—
e1	—	1.90 BSC	—
H	—	2.80 BSC	—
L1	—	0.60 BSC	—
θ	0°	—	8°



Singel 3 | B-2550 Kontich | Belgium | Tel. +32 (0)3 458 30 33
info@alcom.be | www.alcom.be
Rivium 1e straat 52 | 2909 LE Capelle aan den IJssel | The Netherlands
Tel. +31 (0)10 288 25 00 | info@alcom.nl | www.alcom.nl

Copyright© 2021 by HOLTEK SEMICONDUCTOR INC.

The information appearing in this Data Sheet is believed to be accurate at the time of publication. However, Holtek assumes no responsibility arising from the use of the specifications described. The applications mentioned herein are used solely for the purpose of illustration and Holtek makes no warranty or representation that such applications will be suitable without further modification, nor recommends the use of its products for application that may present a risk to human life due to malfunction or otherwise. Holtek's products are not authorized for use as critical components in life support devices or systems. Holtek reserves the right to alter its products without prior notification. For the most up-to-date information, please visit our web site at <http://www.holtek.com>.