

GWX-1610

1610 Package 32.768kHz Watch Crystal

- Competitive pricing for volume applications
- Ultra low profile - 0.5mm high
- Light weight miniature package
- Vacuum sealed for high stability



CONFIGURABLE OPTIONS

Parameter	Option Code
Calibration tolerance	
±20ppm	
Circuit condition	
Any	
6pF	
7pF	
9pF	
12.5pF	

SPECIFICATIONS

Frequency	32.768kHz
Dimensions	1.6 x 1.0 x 0.5mm
Operating temperature range	-40 to +85°C
Storage temperature range	-55 to +125°C
Static capacitance (C ₀)	1.2pF typ
Equivalent series resistance	90kΩ max @ 25°C
Ageing	±3ppm max first year
Drive level	1.0μW max
Turnover temperature (T ₀)	+25°C ±5°C
Frequency / temp coefficient	-0.036ppm/°C ² typ

PACKAGE DRAWING

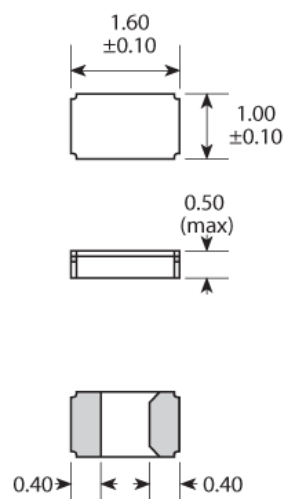

SOLDER PAD LAYOUT

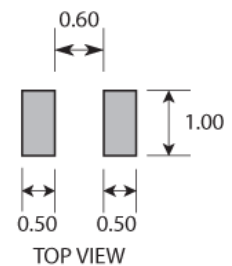

Dimensions in mm

ORDERING INFORMATION

To request a quotation for the GWX-1610 please use the configurable options form to choose the options you require and then submit your configured product to our team. Our expert advisers are always happy to help with your requirements and can be contacted on +44 1460 256 100 or at sales@golledge.com.

Following product selection you will be issued with a seven character Golledge part number. Your Golledge part number is the internationally accepted Golledge manufacturing part number (MPN) that should be used for all project documentation, including bills of materials (BoMs) and purchase orders.

If you have any queries regarding any of our documentation our dedicated sales team will be happy to help.

SOLDERING PROFILE

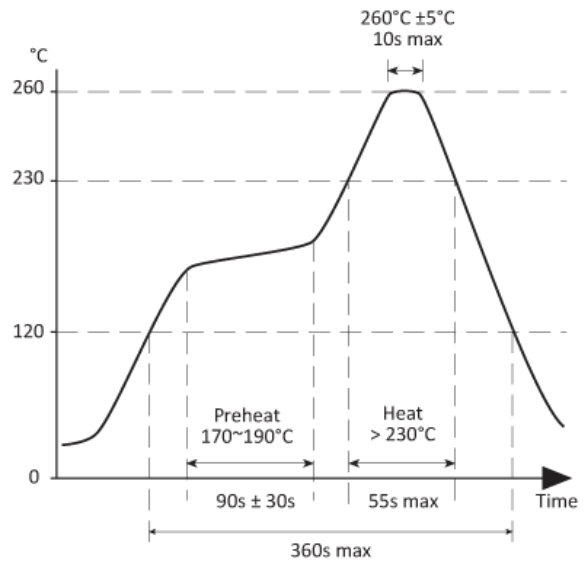

TAPE & REEL SPECIFICATION

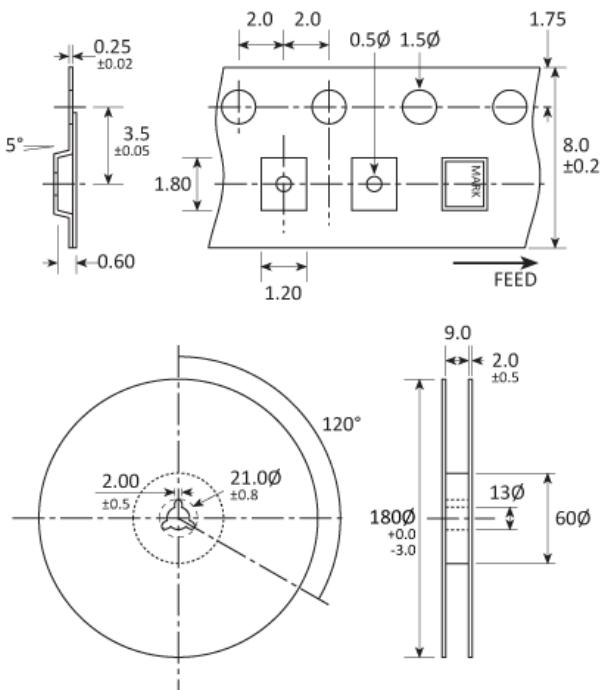

Dimensions in mm

HANDLING & STORAGE



Human Body Model (HBM) 1A (250V to <500V)



Moisture Sensitivity Level (MSL): 1 (or not applicable)

CONSTRUCTION

Ceramic body with gold-plated pads
Metal lid, vacuum sealed

COMPLIANCE

Please refer to our **DOCUMENTS** section for more information.

 Lead-free (< 0.1% by weight)

 RoHS compliant with no exemptions.

 REACH compliant.

 Free of conflict minerals.

 Free from halogens.

 Free from ozone-depleting substances.



Singel 3 | B-2550 Kontich | Belgium | Tel. +32 (0)3 458 30 33
info@alcom.be | www.alcom.be
Rivium 1e straat 52 | 2909 LE Capelle aan den IJssel | The Netherlands
Tel. +31 (0)10 288 25 00 | info@alcom.nl | www.alcom.nl