

Bridgelux® CSP 2323 Series

Product Data Sheet DS955

Introduction

CSP 2323

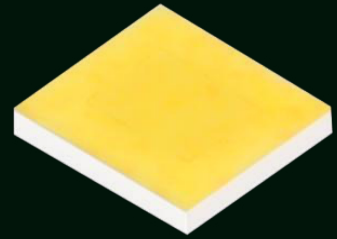

The Bridgelux Chip Scale Package (CSP) 2323 LED offers exceptional performance in an ultra compact size. This CSP LED is hot-color targeted which ensures that the LEDs fall within their specified color bin at the typical application conditions of 85°C. With its superior performance without bonding wires and ability to assemble a densely populated and high luminous flux LED board, the CSP 2323 provides unparalleled design-in flexibility for indoor and outdoor lighting applications. The CSP 2323 is ideal as a drop in replacement for emitters with an industry standard 2.3mm x 2.3mm footprint.

Features

- Competitive efficacy and lumen per dollar
- Industry-standard 2323 footprint, 1-sided emitter
- Excellent color maintenance
- Compatible with SMT
- Superior luminous flux at maximum current for reduced LED count
- Hot-color targeting ensures that color is within the ANSI bin at the typical application conditions of 85°C
- Enables 3- and 5-step MacAdam ellipse custom binning kits
- 120 degrees viewing angle
- Multiple CCT and CRI configurations for a wide range of lighting applications

Benefits

- Lower operating and manufacturing cost
- Ease of design and rapid go-to-market
- Uniform consistent white light
- Reliable and constant white point
- Environmentally friendly, complies with standards
- Design flexibility



Contents

Product Feature Map	2
Product Nomenclature	2
Product Test Conditions	2
Product Selection Guide	3
Performance at Commonly Used Drive Currents	5
Electrical and Thermal Characteristics	10
Absolute Maximum Ratings	11
Product Bin Definitions	12
Performance Curves	15
Typical Radiation Pattern	18
Typical Color Spectrum	19
Mechanical Dimensions	20
Reliability	21
Reflowing Characteristics	22
Packaging	23
Design Resources	25
Precautions	25
Disclaimers	25
About Bridgelux	26

Product Feature Map

Bridgelux CSP LED products offer exceptional performance and color quality all in a highly reliable, cost effective, compact package. Our CSP products come in industry standard package sizes and follow ANSI binning standards.

These LEDs are optimized for cost and performance, helping to ensure highly competitive system lumen per dollar performance while addressing the stringent efficacy and reliability standards required for modern lighting applications.

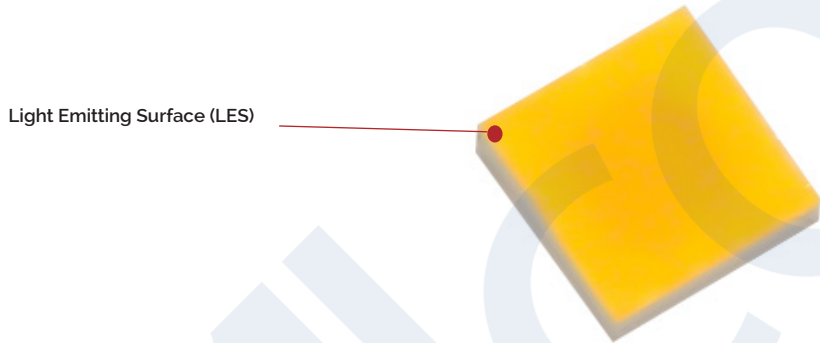

Product Nomenclature

The part number designation for Bridgelux CSP 2323 is explained as follows:

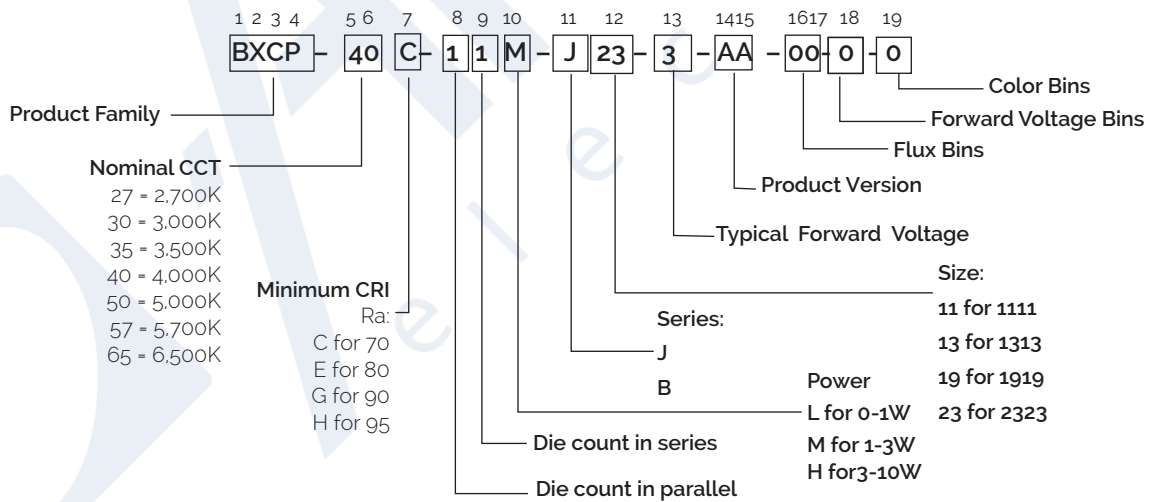

Product Test Conditions

Bridgelux CSP 2323 LEDs are tested and binned with a 10ms pulse of 350mA at T_j (junction temperature) = T_{sp} (solder point temperature) = 85°C. Luminous flux, color and forward voltage are binned at $T_j = T_{sp} = 85^\circ\text{C}$.

Product Selection Guide

The following product configurations are available:

Table 1: Selection Guide, Pulsed Measurement Data at 350mA ($T_j = T_{sp} = 25^\circ\text{C}$)

Part Number ^{1,6}	Nominal CCT ² (K)	CRI ^{3,5}	Nominal Drive Current (mA)	Forward Voltage ^{4,5} (V)			Typical Pulsed Flux ^{4,5} (lm)	Typical Power (W)	Typical Efficacy (lm/W)
				Min	Typical	Max			
BXCP-27C-11M-J23-3-A1-00-0-0	2700	70	350	2.70	2.85	3.30	172	1.0	172
BXCP-30C-11M-J23-3-A1-00-0-0	3000	70	350	2.70	2.85	3.30	180	1.0	180
BXCP-40C-11M-J23-3-A1-00-0-0	4000	70	350	2.70	2.85	3.30	190	1.0	190
BXCP-50C-11M-J23-3-A1-00-0-0	5000	70	350	2.70	2.85	3.30	190	1.0	190
BXCP-57C-11M-J23-3-A1-00-0-0	5700	70	350	2.70	2.85	3.30	190	1.0	190
BXCP-65C-11M-J23-3-A1-00-0-0	6500	70	350	2.70	2.85	3.30	190	1.0	190
BXCP-27E-11M-J23-3-A1-00-0-0	2700	80	350	2.70	2.85	3.30	147	1.0	147
BXCP-30E-11M-J23-3-A1-00-0-0	3000	80	350	2.70	2.85	3.30	155	1.0	155
BXCP-40E-11M-J23-3-A1-00-0-0	4000	80	350	2.70	2.85	3.30	177	1.0	178
BXCP-50E-11M-J23-3-A1-00-0-0	5000	80	350	2.70	2.85	3.30	177	1.0	178
BXCP-57E-11M-J23-3-A1-00-0-0	5700	80	350	2.70	2.85	3.30	177	1.0	178
BXCP-65E-11M-J23-3-A1-00-0-0	6500	80	350	2.70	2.85	3.30	177	1.0	178
BXCP-27G-11M-J23-3-A1-00-0-0	2700	90	350	2.70	2.85	3.30	130	1.0	131
BXCP-30G-11M-J23-3-A1-00-0-0	3000	90	350	2.70	2.85	3.30	139	1.0	139
BXCP-40G-11M-J23-3-A1-00-0-0	4000	90	350	2.70	2.85	3.30	152	1.0	153
BXCP-50G-11M-J23-3-A1-00-0-0	5000	90	350	2.70	2.85	3.30	152	1.0	153
BXCP-57G-11M-J23-3-A1-00-0-0	5700	90	350	2.70	2.85	3.30	152	1.0	153
BXCP-65G-11M-J23-3-A1-00-0-0	6500	90	350	2.70	2.85	3.30	152	1.0	153
BXCP-27H-11M-J23-3-A1-00-0-0	2700	95	350	2.70	2.85	3.30	122	1.0	122
BXCP-30H-11M-J23-3-A1-00-0-0	3000	95	350	2.70	2.85	3.30	130	1.0	130
BXCP-35H-11M-J23-3-A1-00-0-0	3500	95	350	2.70	2.85	3.30	137	1.0	137
BXCP-40H-11M-J23-3-A1-00-0-0	4000	95	350	2.70	2.85	3.30	143	1.0	143
BXCP-50H-11M-J23-3-A1-00-0-0	5000	95	350	2.70	2.85	3.30	143	1.0	143
BXCP-57H-11M-J23-3-A1-00-0-0	5700	95	350	2.70	2.85	3.30	143	1.0	143
BXCP-65H-11M-J23-3-A1-00-0-0	6500	95	350	2.70	2.85	3.30	143	1.0	143

Notes for Table 1:

- The last 6 characters (including hyphens '-') refer to nominal flux, nominal forward voltage, and color bins, respectively. "00-0-0" denotes the full distribution of flux, forward voltage, and 5 SDCM color.
Example: BXCP-40C-11M-J23-3-A1-00-0-0 refers to the full distribution of flux, forward voltage, and color within a 4000K 5-step ANSI standard chromaticity region with a minimum of 70 CRI.
- Product CCT is hot targeted at $T_{sp} = 85^\circ\text{C}$. Nominal CCT as defined by ANSI C78.377-2011.
- Listed CRIs are minimum values and include test tolerance.
- Products tested under pulsed condition (10ms pulse width) at nominal drive current where $T_j = T_{sp} = 25^\circ\text{C}$.
- Bridgelux maintains a $\pm 7.5\%$ tolerance on luminous flux measurements, $\pm 0.1\text{V}$ tolerance on forward voltage measurements, and ± 2 tolerance on CRI measurements for the CSP.
- Refer to Table 6 and Table 7 for Bridgelux CSP Luminous Flux Binning and Forward Voltage Binning information.

Product Selection Guide

Table 2: Selection Guide, Pulsed Measurement Data at 350mA ($T_j = T_{sp} = 85^\circ\text{C}$)

Part Number ^{1,5}	Nominal CCT ² (K)	CRI ^{3,4}	Nominal Drive Current (mA)	Forward Voltage ⁴ (V)			Typical Pulsed Flux ⁴ (lm)	Typical Power (W)	Typical Efficacy (lm/W)
				Min	Typical	Max			
BXCP-27C-11M-J23-3-A1-00-0-0	2700	70	350	2.60	2.75	3.20	158	1.0	164
BXCP-30C-11M-J23-3-A1-00-0-0	3000	70	350	2.60	2.75	3.20	166	1.0	172
BXCP-40C-11M-J23-3-A1-00-0-0	4000	70	350	2.60	2.75	3.20	175	1.0	182
BXCP-50C-11M-J23-3-A1-00-0-0	5000	70	350	2.60	2.75	3.20	175	1.0	182
BXCP-57C-11M-J23-3-A1-00-0-0	5700	70	350	2.60	2.75	3.20	175	1.0	182
BXCP-65C-11M-J23-3-A1-00-0-0	6500	70	350	2.60	2.75	3.20	175	1.0	182
BXCP-27E-11M-J23-3-A1-00-0-0	2700	80	350	2.60	2.75	3.20	135	1.0	140
BXCP-30E-11M-J23-3-A1-00-0-0	3000	80	350	2.60	2.75	3.20	143	1.0	149
BXCP-40E-11M-J23-3-A1-00-0-0	4000	80	350	2.60	2.75	3.20	163	1.0	169
BXCP-50E-11M-J23-3-A1-00-0-0	5000	80	350	2.60	2.75	3.20	163	1.0	169
BXCP-57E-11M-J23-3-A1-00-0-0	5700	80	350	2.60	2.75	3.20	163	1.0	169
BXCP-65E-11M-J23-3-A1-00-0-0	6500	80	350	2.60	2.75	3.20	163	1.0	169
BXCP-27G-11M-J23-3-A1-00-0-0	2700	90	350	2.60	2.75	3.20	120	1.0	125
BXCP-30G-11M-J23-3-A1-00-0-0	3000	90	350	2.60	2.75	3.20	125	1.0	130
BXCP-40G-11M-J23-3-A1-00-0-0	4000	90	350	2.60	2.75	3.20	137	1.0	142
BXCP-50G-11M-J23-3-A1-00-0-0	5000	90	350	2.60	2.75	3.20	137	1.0	142
BXCP-57G-11M-J23-3-A1-00-0-0	5700	90	350	2.60	2.75	3.20	137	1.0	142
BXCP-65G-11M-J23-3-A1-00-0-0	6500	90	350	2.60	2.75	3.20	137	1.0	142
BXCP-27H-11M-J23-3-A1-00-0-0	2700	95	350	2.60	2.75	3.20	110	1.0	114
BXCP-30H-11M-J23-3-A1-00-0-0	3000	95	350	2.60	2.75	3.20	117	1.0	122
BXCP-35H-11M-J23-3-A1-00-0-0	3500	95	350	2.60	2.75	3.20	123	1.0	128
BXCP-40H-11M-J23-3-A1-00-0-0	4000	95	350	2.60	2.75	3.20	129	1.0	134
BXCP-50H-11M-J23-3-A1-00-0-0	5000	95	350	2.60	2.75	3.20	129	1.0	134
BXCP-57H-11M-J23-3-A1-00-0-0	5700	95	350	2.60	2.75	3.20	129	1.0	134
BXCP-65H-11M-J23-3-A1-00-0-0	6500	95	350	2.60	2.75	3.20	129	1.0	134

Notes for Table 2:

- The last 6 characters (including hyphens '-') refer to nominal flux, nominal forward voltage, and color bins, respectively. "00-0-0" denotes the full distribution of flux, forward voltage, and 5 SDCM color.
Example: BXCP-40C-11M-J23-3-A1-00-0-0 refers to the full distribution of flux, forward voltage, and color within a 4000K 5-step ANSI standard chromaticity region with a minimum of 70 CRI.
- Product CCT is hot targeted at $T_{sp} = 85^\circ\text{C}$. Nominal CCT as defined by ANSI C78.377-2011.
- Listed CRIs are minimum values and include test tolerance.
- Bridgelux maintains a $\pm 7.5\%$ tolerance on luminous flux measurements, $\pm 0.1\text{V}$ tolerance on forward voltage measurements, and ± 2 tolerance on CRI measurements for the CSP.
- Refer to Table 6 and Table 7 for Bridgelux CSP Luminous Flux Binning and Forward Voltage Binning information.
- Products tested under pulsed condition (10ms pulse width) at nominal drive current where $T_j = T_{sp} = 85^\circ\text{C}$.

Performance at Commonly Used Drive Currents

CSP 2323 LEDs are tested to the specifications shown using the nominal drive currents in Table 1. CSP 2323 may also be driven at other drive currents dependent on specific application design requirements. The performance at any drive current can be derived from the current vs. voltage characteristics shown in Figure 2 and the relative luminous flux vs. current characteristics shown in Figure 3. The performance at commonly used drive currents is summarized in Table 3.

Table 3: Performance at Commonly Used Drive Currents

Part Number	CRI	Drive Current ¹ (mA)	Typical V_f $T_{sp} = 25^\circ\text{C}$ (V)	Typical Power $T_{sp} = 25^\circ\text{C}$ (W)	Typical Pulsed Flux ² $T_{sp} = 25^\circ\text{C}$ (lm)	Typical Pulsed Flux ³ $T_{sp} = 85^\circ\text{C}$ (lm)	Typical Efficacy $T_{sp} = 25^\circ\text{C}$ (lm/W)
BXCP-27C-11M-J23-3-A1-00-0-0	70	50	2.63	0.1	26	24	199
		200	2.74	0.5	101	93	185
		350	2.85	1.0	172	158	172
		700	3.01	2.1	317	292	150
		1000	3.16	3.2	429	395	136
		1400	3.34	4.7	562	517	120
BXCP-30C-11M-J23-3-A1-00-0-0	70	50	2.63	0.1	27	25	209
		200	2.74	0.5	107	98	194
		350	2.85	1.0	180	166	180
		700	3.01	2.1	333	307	158
		1000	3.16	3.2	451	415	143
		1400	3.34	4.7	590	543	126
BXCP-40C-11M-J23-3-A1-00-0-0	70	50	2.63	0.1	29	27	220
		200	2.74	0.5	112	103	205
		350	2.85	1.0	190	175	190
		700	3.01	2.1	351	323	167
		1000	3.16	3.2	475	437	151
		1400	3.34	4.7	622	572	133
BXCP-50C-11M-J23-3-A1-00-0-0	70	50	2.63	0.1	29	27	220
		200	2.74	0.5	112	103	205
		350	2.85	1.0	190	175	190
		700	3.01	2.1	351	323	167
		1000	3.16	3.2	475	437	151
		1400	3.34	4.7	622	572	133
BXCP-57C-11M-J23-3-A1-00-0-0	70	50	2.63	0.1	29	27	220
		200	2.74	0.5	112	103	205
		350	2.85	1.0	190	175	190
		700	3.01	2.1	351	323	167
		1000	3.16	3.2	475	437	151
		1400	3.34	4.7	622	572	133
BXCP-65C-11M-J23-3-A1-00-0-0	70	50	2.63	0.1	29	27	220
		200	2.74	0.5	112	103	205
		350	2.85	1.0	190	175	190
		700	3.01	2.1	351	323	167
		1000	3.16	3.2	475	437	151
		1400	3.34	4.7	622	572	133

Notes for Table 3:

1. Alternate drive currents in Table 3 are provided for reference only and are not a guarantee of performance.
2. Bridgelux maintains a $\pm 7.5\%$ tolerance on flux measurements.
3. Typical pulsed performance values are provided as reference only and are not a guarantee of performance.

Performance at Commonly Used Drive Currents

Table 3: Performance at Commonly Used Drive Currents (Continued)

Part Number	CRI	Drive Current ¹ (mA)	Typical V_f $T_{sp} = 25^\circ\text{C}$ (V)	Typical Power $T_{sp} = 25^\circ\text{C}$ (W)	Typical Pulsed Flux ² $T_{sp} = 25^\circ\text{C}$ (lm)	Typical Pulsed Flux ³ $T_{sp} = 85^\circ\text{C}$ (lm)	Typical Efficacy $T_{sp} = 25^\circ\text{C}$ (lm/W)
BXCP-27E-11M-J23-3-A1-00-0-0	80	50	2.63	0.1	22	21	170
		200	2.74	0.5	87	80	158
		350	2.85	1.0	147	135	147
		700	3.01	2.1	271	249	129
		1000	3.16	3.2	367	337	116
		1400	3.34	4.7	480	442	103
BXCP-30E-11M-J23-3-A1-00-0-0	80	50	2.63	0.1	24	22	180
		200	2.74	0.5	92	84	168
		350	2.85	1.0	155	143	155
		700	3.01	2.1	287	264	136
		1000	3.16	3.2	388	357	123
		1400	3.34	4.7	508	468	109
BXCP-40E-11M-J23-3-A1-00-0-0	80	50	2.63	0.1	27	25	205
		200	2.74	0.5	105	96	191
		350	2.85	1.0	177	163	178
		700	3.01	2.1	327	301	155
		1000	3.16	3.2	443	407	140
		1400	3.34	4.7	580	533	124
BXCP-50E-11M-J23-3-A1-00-0-0	80	50	2.63	0.1	27	25	205
		200	2.74	0.5	105	96	191
		350	2.85	1.0	177	163	178
		700	3.01	2.1	327	301	155
		1000	3.16	3.2	443	407	140
		1400	3.34	4.7	580	533	124
BXCP-57E-11M-J23-3-A1-00-0-0	80	50	2.63	0.1	27	25	205
		200	2.74	0.5	105	96	191
		350	2.85	1.0	177	163	178
		700	3.01	2.1	327	301	155
		1000	3.16	3.2	443	407	140
		1400	3.34	4.7	580	533	124
BXCP-65E-11M-J23-3-A1-00-0-0	80	50	2.63	0.1	27	25	205
		200	2.74	0.5	105	96	191
		350	2.85	1.0	177	163	178
		700	3.01	2.1	327	301	155
		1000	3.16	3.2	443	407	140
		1400	3.34	4.7	580	533	124

Notes for Table 3:

1. Alternate drive currents in Table 3 are provided for reference only and are not a guarantee of performance.
2. Bridgelux maintains a $\pm 7.5\%$ tolerance on flux measurements.
3. Typical pulsed performance values are provided as reference only and are not a guarantee of performance.

Performance at Commonly Used Drive Currents

Table 3: Performance at Commonly Used Drive Currents (Continued)

Part Number	CRI	Drive Current ¹ (mA)	Typical V_f $T_{sp} = 25^\circ\text{C}$ (V)	Typical Power $T_{sp} = 25^\circ\text{C}$ (W)	Typical Pulsed Flux ² $T_{sp} = 25^\circ\text{C}$ (lm)	Typical Pulsed Flux ³ $T_{sp} = 85^\circ\text{C}$ (lm)	Typical Efficacy $T_{sp} = 25^\circ\text{C}$ (lm/W)
BXCP-27G-11M-J23-3-A1-00-0-0	90	50	2.63	0.1	20	18	151
		200	2.74	0.5	77	71	141
		350	2.85	1.0	130	120	131
		700	3.01	2.1	241	222	114
		1000	3.16	3.2	326	300	103
		1400	3.34	4.7	427	393	91
BXCP-30G-11M-J23-3-A1-00-0-0	90	50	2.63	0.1	21	19	161
		200	2.74	0.5	82	74	150
		350	2.85	1.0	139	125	139
		700	3.01	2.1	256	231	122
		1000	3.16	3.2	347	312	110
		1400	3.34	4.7	454	409	97
BXCP-40G-11M-J23-3-A1-00-0-0	90	50	2.63	0.1	23	21	176
		200	2.74	0.5	90	81	164
		350	2.85	1.0	152	137	153
		700	3.01	2.1	281	253	133
		1000	3.16	3.2	380	342	121
		1400	3.34	4.7	498	448	107
BXCP-50G-11M-J23-3-A1-00-0-0	90	50	2.63	0.1	23	21	176
		200	2.74	0.5	90	81	164
		350	2.85	1.0	152	137	153
		700	3.01	2.1	281	253	133
		1000	3.16	3.2	380	342	121
		1400	3.34	4.7	498	448	107
BXCP-57G-11M-J23-3-A1-00-0-0	90	50	2.63	0.1	23	21	176
		200	2.74	0.5	90	81	164
		350	2.85	1.0	152	137	153
		700	3.01	2.1	281	253	133
		1000	3.16	3.2	380	342	121
		1400	3.34	4.7	498	448	107
BXCP-65G-11M-J23-3-A1-00-0-0	90	50	2.63	0.1	23	21	176
		200	2.74	0.5	90	81	164
		350	2.85	1.0	152	137	153
		700	3.01	2.1	281	253	133
		1000	3.16	3.2	380	342	121
		1400	3.34	4.7	498	448	107

Notes for Table 3:

1. Alternate drive currents in Table 3 are provided for reference only and are not a guarantee of performance.
2. Bridgelux maintains a $\pm 7.5\%$ tolerance on flux measurements.
3. Typical pulsed performance values are provided as reference only and are not a guarantee of performance.

Performance at Commonly Used Drive Currents

Table 3: Performance at Commonly Used Drive Currents (Continued)

Part Number	CRI	Drive Current ¹ (mA)	Typical V_f $T_{sp} = 25^\circ\text{C}$ (V)	Typical Power $T_{sp} = 25^\circ\text{C}$ (W)	Typical Pulsed Flux ² $T_{sp} = 25^\circ\text{C}$ (lm)	Typical Pulsed Flux ³ $T_{sp} = 85^\circ\text{C}$ (lm)	Typical Efficacy $T_{sp} = 25^\circ\text{C}$ (lm/W)
BXCP-27H-11M-J23-3-A1-00-0-0	95	50	2.63	0.1	19	17	141
		200	2.74	0.5	72	65	132
		350	2.85	1.0	122	110	122
		700	3.01	2.1	226	203	107
		1000	3.16	3.2	305	275	97
		1400	3.34	4.7	400	360	86
BXCP-30H-11M-J23-3-A1-00-0-0	95	50	2.63	0.1	20	18	150
		200	2.74	0.5	77	69	140
		350	2.85	1.0	130	117	130
		700	3.01	2.1	240	216	114
		1000	3.16	3.2	325	292	103
		1400	3.34	4.7	425	383	91
BXCP-35H-11M-J23-3-A1-00-0-0	95	50	2.63	0.1	21	19	158
		200	2.74	0.5	81	73	147
		350	2.85	1.0	137	123	137
		700	3.01	2.1	252	227	120
		1000	3.16	3.2	342	307	108
		1400	3.34	4.7	447	402	96
BXCP-40H-11M-J23-3-A1-00-0-0	95	50	2.63	0.1	22	20	166
		200	2.74	0.5	85	76	154
		350	2.85	1.0	143	129	143
		700	3.01	2.1	265	238	126
		1000	3.16	3.2	358	322	114
		1400	3.34	4.7	469	422	100
BXCP-50H-11M-J23-3-A1-00-0-0	95	50	2.63	0.1	22	20	166
		200	2.74	0.5	85	76	154
		350	2.85	1.0	143	129	143
		700	3.01	2.1	265	238	126
		1000	3.16	3.2	358	322	114
		1400	3.34	4.7	469	422	100
BXCP-57H-11M-J23-3-A1-00-0-0	95	50	2.63	0.1	22	20	166
		200	2.74	0.5	85	76	154
		350	2.85	1.0	143	129	143
		700	3.01	2.1	265	238	126
		1000	3.16	3.2	358	322	114
		1400	3.34	4.7	469	422	100

Notes for Table 3:

1. Alternate drive currents in Table 3 are provided for reference only and are not a guarantee of performance.
2. Bridgelux maintains a $\pm 7.5\%$ tolerance on flux measurements.
3. Typical pulsed performance values are provided as reference only and are not a guarantee of performance.

Performance at Commonly Used Drive Currents

Table 3: Performance at Commonly Used Drive Currents (Continued)

Part Number	CRI	Drive Current ¹ (mA)	Typical V_f $T_{sp} = 25^\circ\text{C}$ (V)	Typical Power $T_{sp} = 25^\circ\text{C}$ (W)	Typical Pulsed Flux ² $T_{sp} = 25^\circ\text{C}$ (lm)	Typical Pulsed Flux ³ $T_{sp} = 85^\circ\text{C}$ (lm)	Typical Efficacy $T_{sp} = 25^\circ\text{C}$ (lm/W)
BXCP-65H-11M-J23-3-A1-00-0-0	95	50	2.63	0.1	22	20	166
		200	2.74	0.5	85	76	154
		350	2.85	1.0	143	129	143
		700	3.01	2.1	265	238	126
		1000	3.16	3.2	358	322	114
		1400	3.34	4.7	469	422	100

Notes for Table 3:

1. Alternate drive currents in Table 3 are provided for reference only and are not a guarantee of performance.
2. Bridgelux maintains a $\pm 7.5\%$ tolerance on flux measurements.
3. Typical pulsed performance values are provided as reference only and are not a guarantee of performance.

Electrical and Thermal Characteristics

Table 4: Electrical and Thermal Characteristics

Part Number ¹	Drive Current (mA)	Forward Voltage ^{2,3} (V)			Typical Temperature Coefficient of Forward Voltage ⁴ $\Delta V_f / \Delta T$ (mV/°C)	Typical Thermal Resistance Junction to Solder Point ^{5,6} R_{j-sp} (°C/W)
		Minimum	Typical	Maximum		
BXCP-xxx-11M-J23-3-A1-00-0-0	350	2.60	2.75	3.20	-1.1	1.75

Notes for Table 4:

1. The last 6 characters (including hyphens '-') refer to nominal flux, nominal forward voltage, and color bins, respectively. "00-0-0" denotes the full distribution of flux, forward voltage, and 5 SDCM color.
Example: BXCP-40C-11M-J23-3-A1-00-0-0 refers to the full distribution of flux, forward voltage, and color within a 4000K 5-step ANSI standard chromaticity region with a minimum of 70 CRI.
2. Products tested under pulsed condition (10ms pulse width) at nominal drive current where $T_{sp} = 85^{\circ}\text{C}$.
3. Bridgelux maintains a tolerance of $\pm 0.1\text{V}$ on forward voltage measurements.
4. Products measured between 25°C and 105°C at nominal drive current (10ms pulse width).
5. Thermal Resistance values based on 4000K 70 CRI product.
6. Thermal resistance value was calculated using total electrical input power; optical power was not subtracted from input power.

Absolute Maximum Ratings

Table 5: Maximum Ratings

Parameter	Maximum Rating
LED Junction Temperature (T_j)	135°C
Storage Temperature	-40°C to +125°C
Operating Solder Point Temperature (T_{sp})	-40°C to +105°C
Soldering Temperature	260°C or lower for a maximum of 10 seconds
Maximum Drive Current	1400mA
Maximum Peak Pulsed Forward Current ¹	2000mA
Maximum Reverse Voltage ²	-5V
Moisture Sensitivity Rating	MSL 3
Electrostatic Discharge	2kV HBM. JEDEC-JS-001-HBM and JEDEC-JS-001-2012

Notes for Table 5:

1. Bridgelux recommends a maximum duty cycle of 10% and pulse width of 10 ms when operating CSP LED at maximum peak pulsed current specified. Maximum peak pulsed currents indicate values where CSP LED can be driven without catastrophic failures.
2. Light emitting diodes are not designed to be driven in reverse voltage and will not produce light under this condition. Maximum rating provided for reference only.

Product Bin Definitions

Table 6 lists the standard photometric luminous flux bins for Bridgelux CSP 2323 LEDs. Although several bins are outlined, product availability in a particular bin varies by production run and by product performance. Not all bins are available in all CCTs.

Table 6: Luminous Flux Bin Definitions at 350mA, $T_{sp}=85^{\circ}\text{C}$

Bin Code	Minimum	Maximum	Unit	Condition
H1	100	110	lm	$I_F=350\text{mA}$
I1	110	120		
J1	120	130		
K1	130	140		
M1	140	150		
N1	150	160		
P1	160	170		
Q1	170	180		
R1	180	190		

Note for Table 6:

1. Bridgelux maintains a tolerance of $\pm 7.5\%$ on luminous flux measurements.

Table 7: Forward Voltage Bin Definition at 350mA, $T_{sp}=85^{\circ}\text{C}$

Bin Code	Minimum	Maximum	Unit	Condition
C	2.6	2.8	V	$I_F=350\text{mA}$
D	2.8	3.0		
E	3.0	3.2		

Note for Table 7:

1. Bridgelux maintains a tolerance of $\pm 0.1\text{V}$ on forward voltage measurements.

Product Bin Definitions

Table 8: 3- and 5-step MacAdam Ellipse Color Bin Definitions ($T_{sp}=85^{\circ}\text{C}$)

Table 8: 3- and 5-step MacAdam Ellipse Color Bin Definitions ($T_{sp}=85^{\circ}\text{C}$)							
CCT	Color Space	Center Point		Major Axis	minor Axis	θ' (angle)	Color Bin ^(2,3)
		x	y				
2700K	2	0.4578	0.4101	0.0054	0.0028	53.70	2
	3			0.0081	0.0042		3
	5			0.0135	0.0070		5(E/F/G/H)
3000K	2	0.4338	0.4030	0.0056	0.0027	53.22	2
	3			0.0083	0.0041		3
	5			0.0139	0.0068		5(E/F/G/H)
3500K	2	0.4073	0.3917	0.0062	0.0028	54.00	2
	3			0.0093	0.0041		3
	5			0.0155	0.0069		5(E/F/G/H)
4000K	2	0.3818	0.3797	0.0063	0.0027	53.72	2
	3			0.0094	0.0040		3
	5			0.0157	0.0067		5(E/F/G/H)
5000K	2	0.3447	0.3553	0.0055	0.0024	59.62	2
	3			0.0082	0.0035		3
	5			0.0137	0.0059		5(E/F/G/H)
5700K	2	0.3287	0.3417	0.0050	0.0021	59.09	2
	3			0.0075	0.0032		3
	5			0.0124	0.0053		5(E/F/G/H)
6500K	2	0.3123	0.3282	0.0045	0.0019	58.57	2
	3			0.0067	0.0029		3
	5			0.0112	0.0048		5(E/F/G/H)

Note for Table 8:

1. Bridgelux maintains a tolerance of ± 0.007 on x and y color coordinates in the CIE 1931 color space.
2. MacAdam Ellipse Color bin code for $\text{CRI} \geq 90$: 2(2 SDCM)/ 3(3 SDCM)/ EFGH(5 SDCM).
3. MacAdam Ellipse Color bin code for $\text{CRI} < 90$: 3(3 SDCM)/ 5(5 SDCM).

Product Bin Definitions

Figure 1: C.I.E. 1931 Chromaticity Diagram (Color Bin Structure, $T_{sp} = 85^{\circ}\text{C}$)

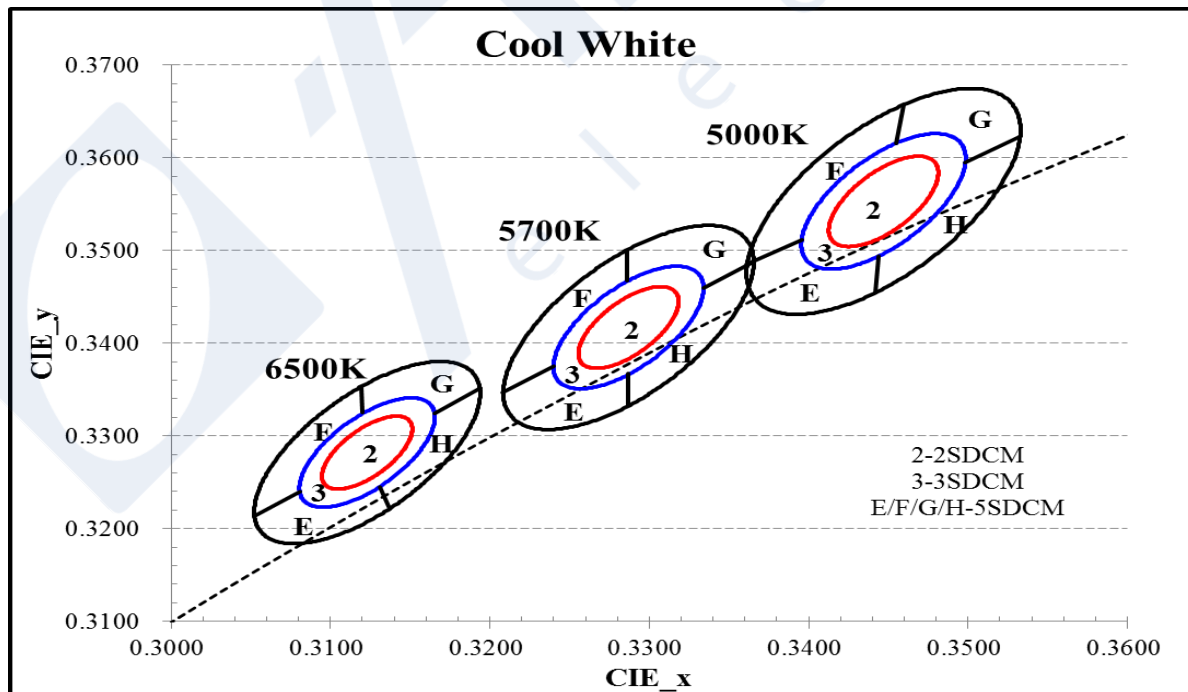
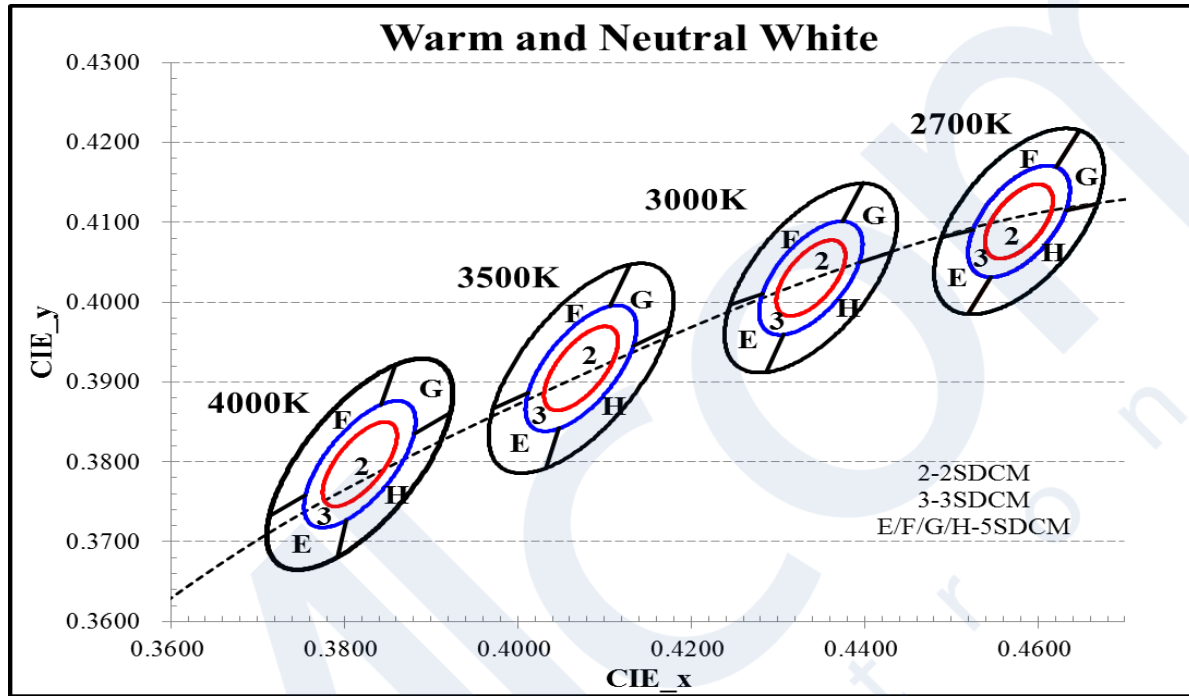

Performance Curves

Figure 2: Drive Current vs. Voltage ($T_{sp}=85^{\circ}\text{C}$)

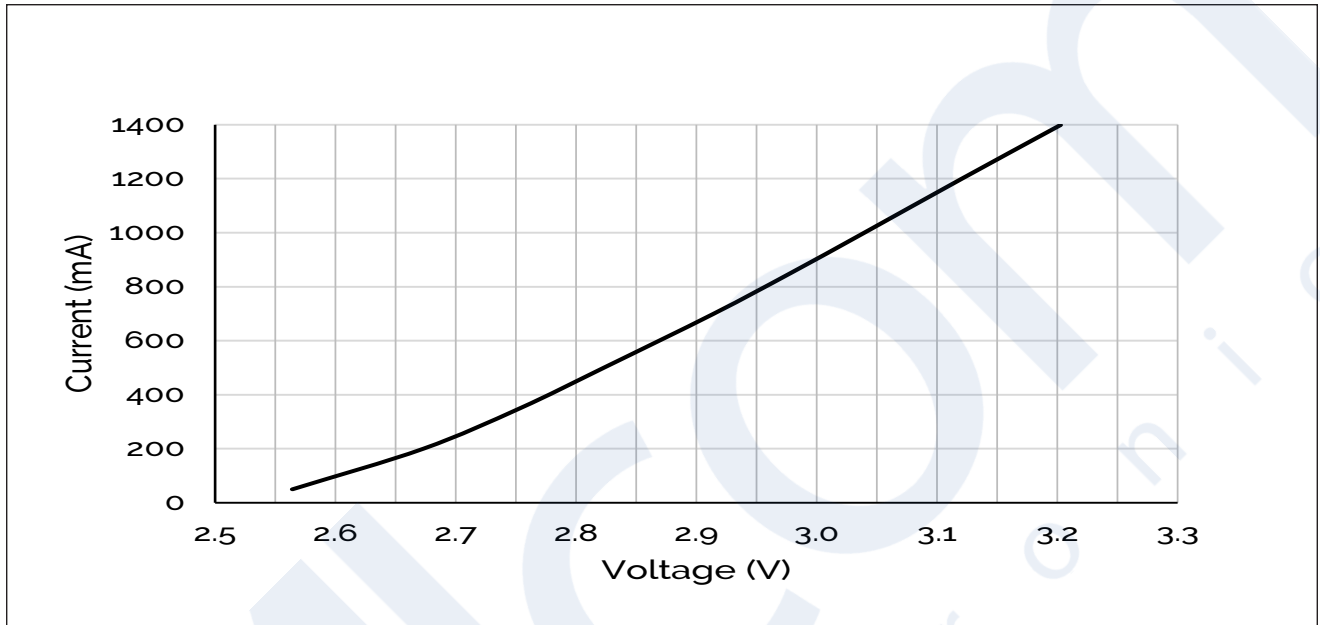
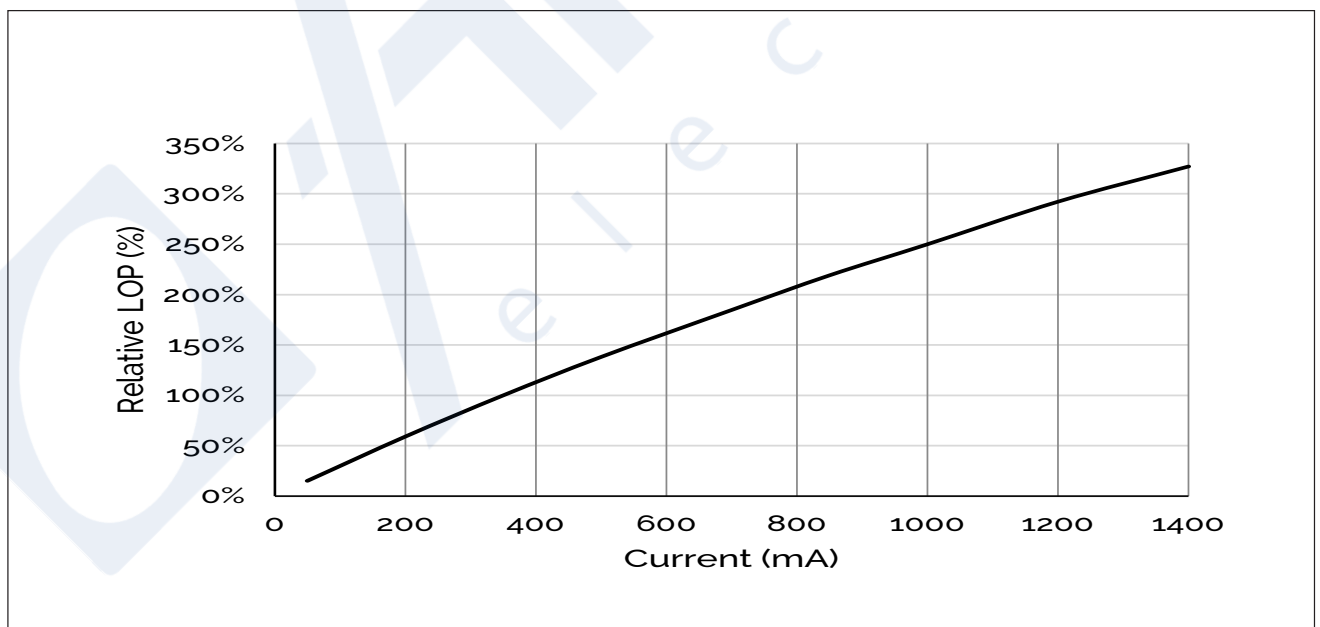

Figure 3: Typical Relative Luminous Flux vs. Drive Current ($T_{sp}=85^{\circ}\text{C}$)



Note for Figure 3:

1. Bridgelux does not recommend driving this CSP LED at low current ($< 10\text{mA}$). Doing so may produce unpredictable results. Pulse width modulation (PWM) is recommended for dimming effects.

Performance Curves

Figure 4: Typical Relative Flux vs. Solder Point Temperature_350mA

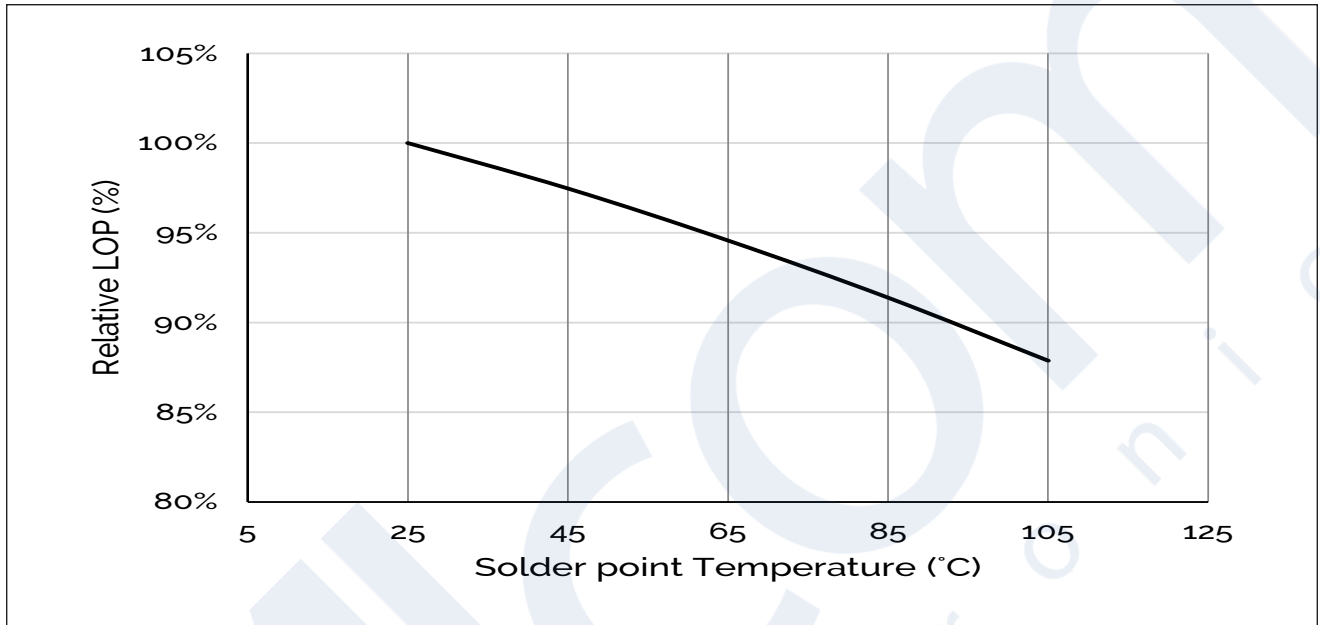
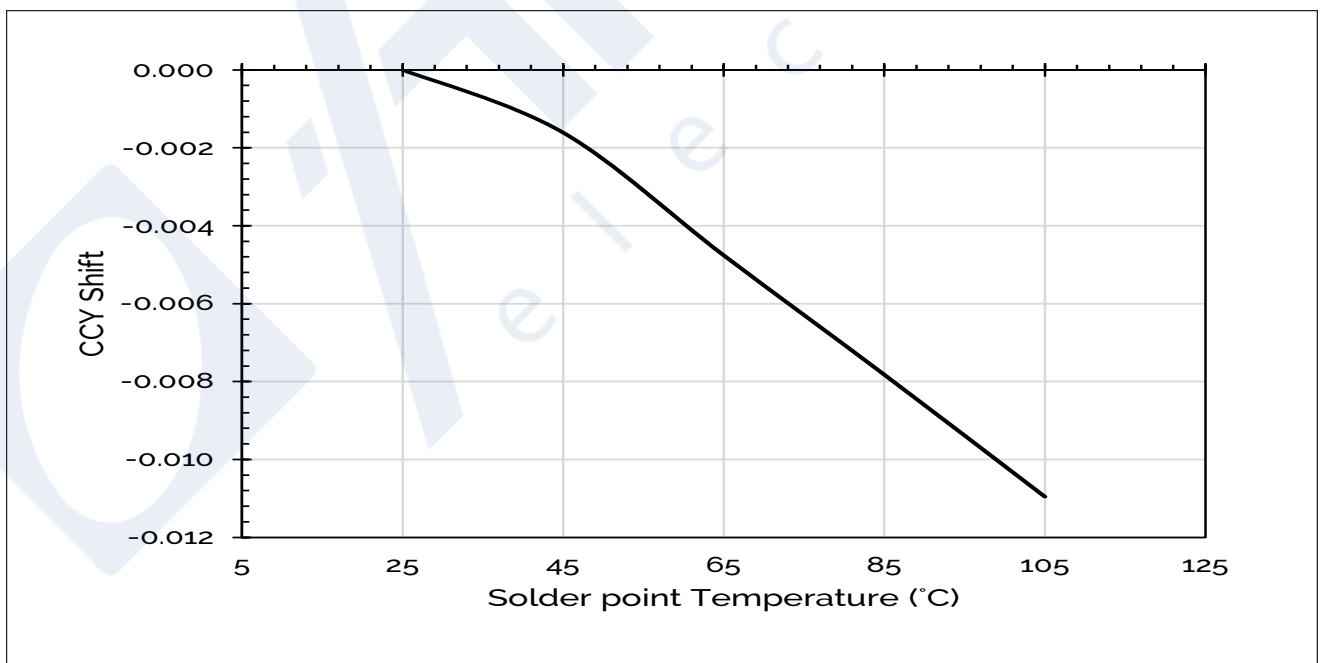

Figure 5: Typical ccY Shift vs. Solder Point Temperature_350mA



Notes for Figures 4 & 5:

- 1.Characteristics shown for neutral white based on 4000K and 70 CRI.
2. For other color SKUs, the shift in color will vary. Please contact your Bridgelux Sales Representative for more information.

Performance Curves

Figure 6: Typical ccx Shift vs. Solder Point Temperature_350mA

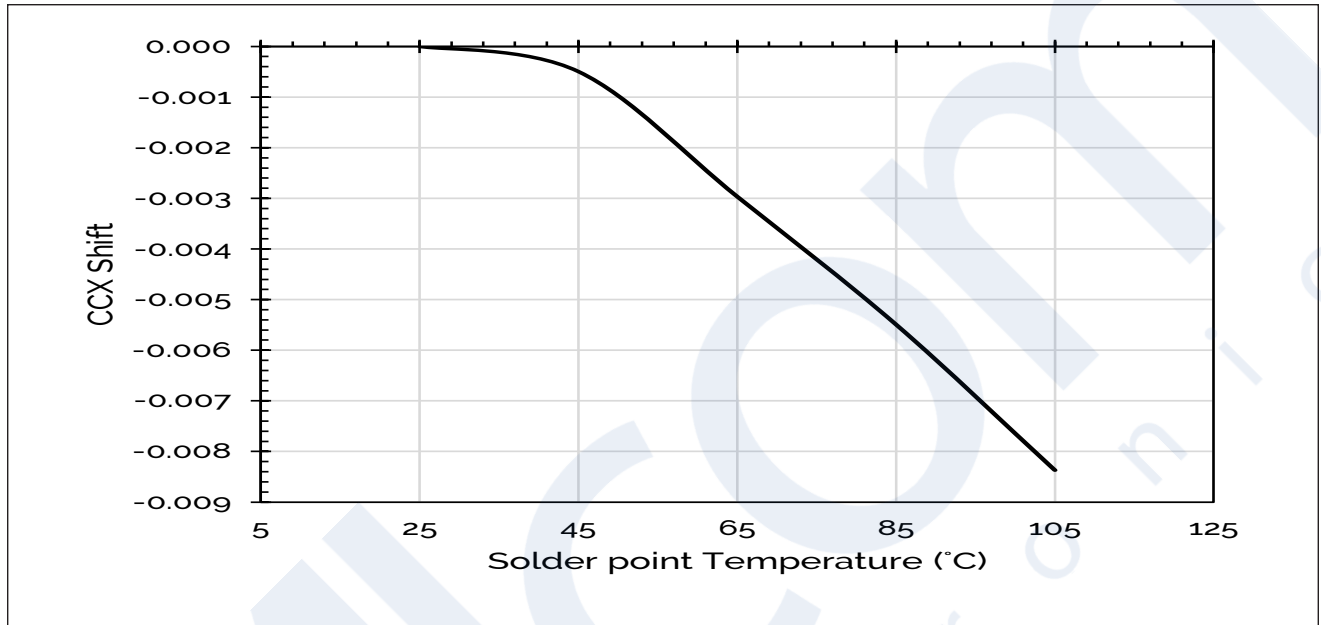

Notes for Figure 6:

1. Characteristics shown for warm white based on 4000K and 70 CRI.
2. For other color SKUs, the shift in color will vary. Please contact your Bridgelux Sales Representative for more information.

Figure 7: Drive Current vs Solder Point Temperature

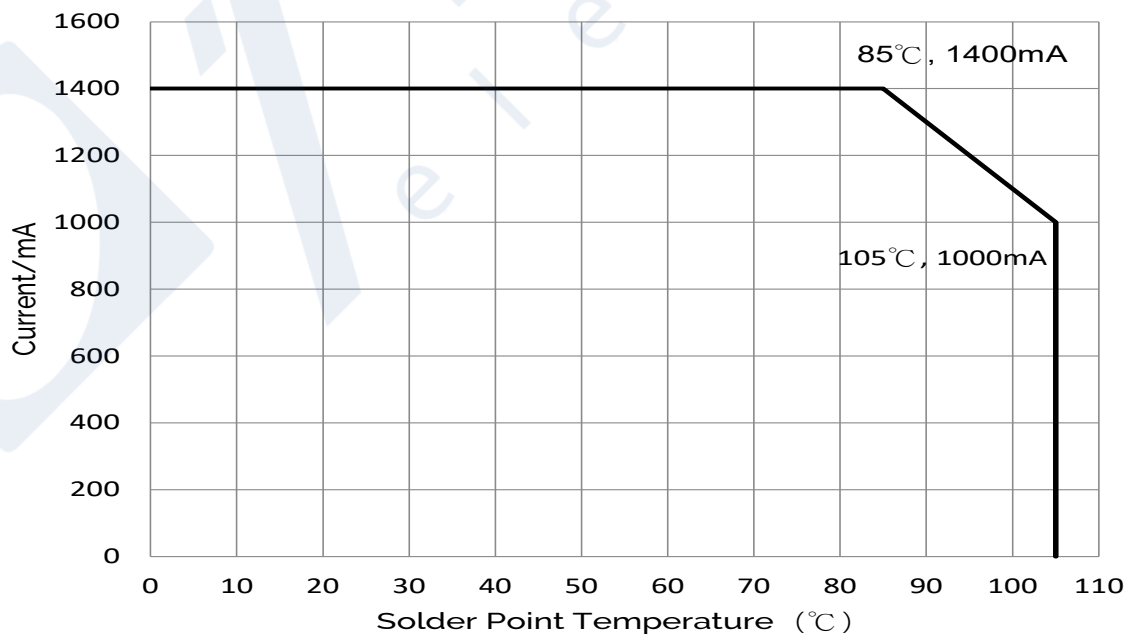

Typical Radiation Pattern

Figure 8: Typical Spatial Radiation Pattern at 350mA, $T_{sp} = 25^{\circ}\text{C}$

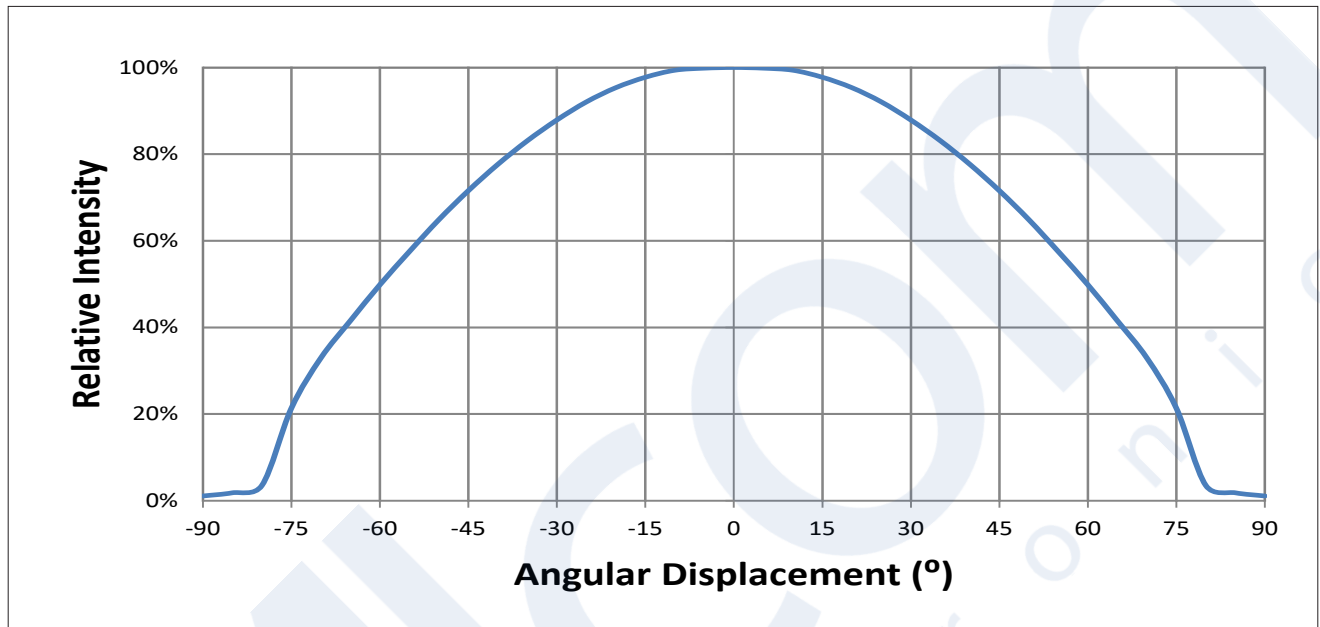

Notes for Figure 8:

1. Typical viewing angle is 120° .
2. The viewing angle is defined as the off axis angle from the centerline where I_v is $\frac{1}{2}$ of the peak value.

Figure 9: Typical Polar Radiation Pattern at 350mA, $T_{sp} = 25^{\circ}\text{C}$

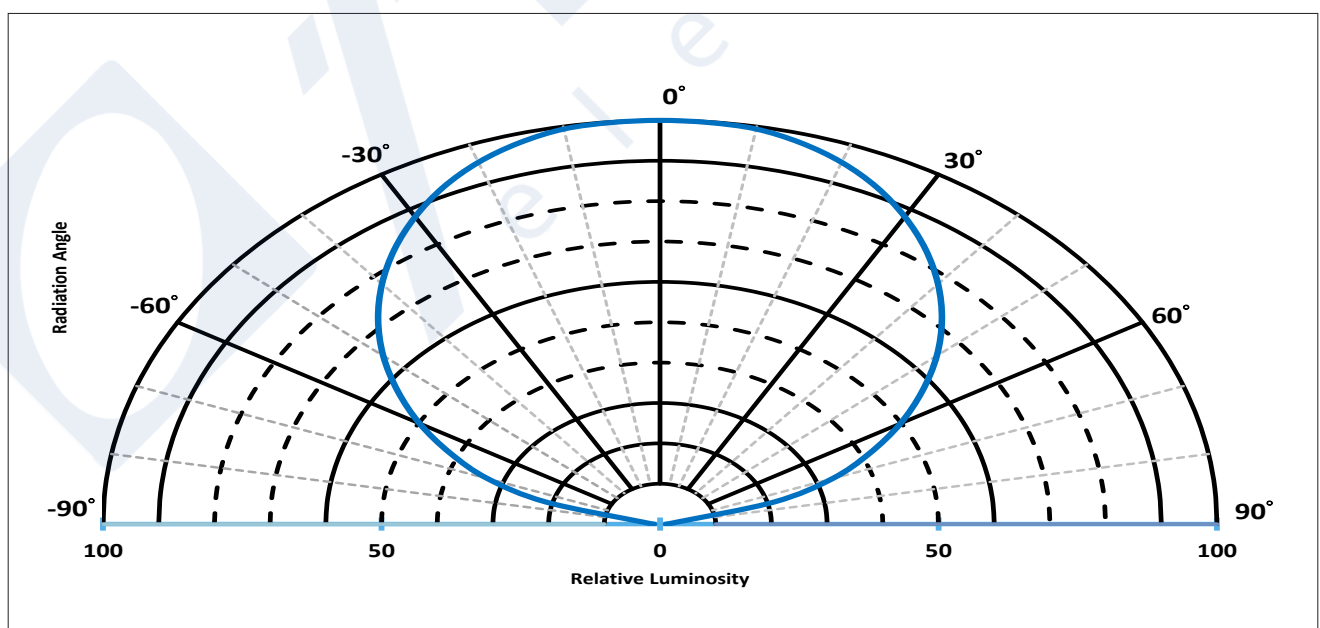

Typical Color Spectrum

Figure 10: Typical Color Spectrum

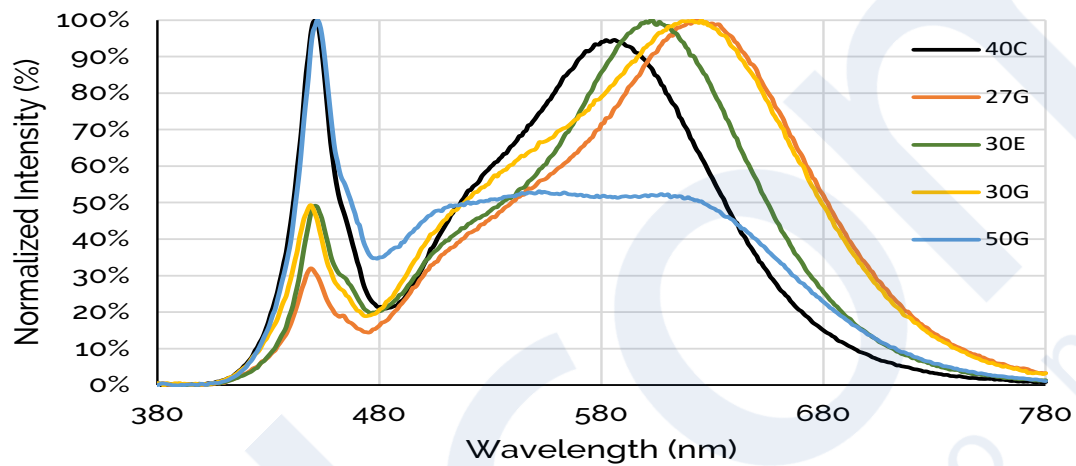

Notes for Figure 10:

1. Color spectra measured at nominal current for $T_{sp} = 85^{\circ}\text{C}$
2. Color spectra shown for neutral white is 4000K and 70 CRI.
3. Color spectra shown for warm white is 2700K and 90 CRI.
4. Color spectra shown for warm white is 3000K and 80 CRI.
5. Color spectra shown for warm white is 3000K and 90 CRI.
6. Color spectra shown for cool white is 5000K and 90 CRI.

Mechanical Dimensions

Figure 11: Drawing for CSP 2323

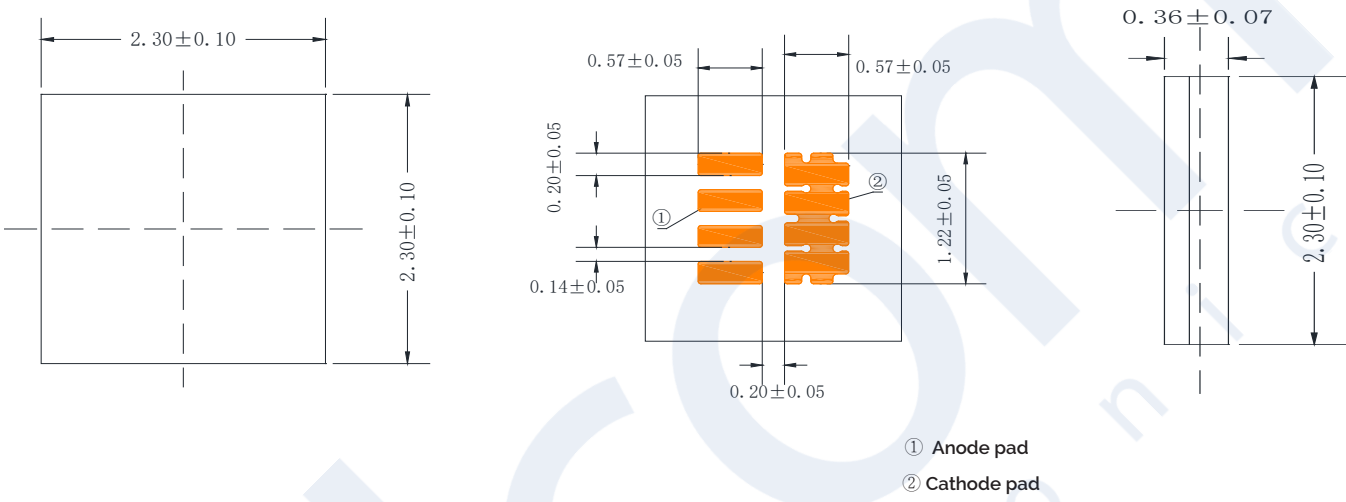

Notes for Figure 11:

1. Drawings are not to scale.
2. Drawing dimensions are in millimeters.
3. Unless otherwise specified, tolerances are ± 0.10 mm.
4. The optical center of the LED emitter is nominally defined by the mechanical center of the emitter. The light emitting surface (LES) is centered on the mechanical center of the LED emitter to a tolerance of ± 0.2 mm

Recommended PCB Soldering Pad Pattern

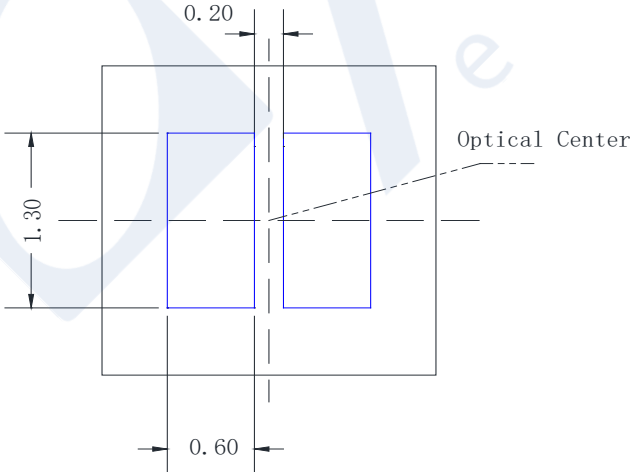

Reliability

Table 9: Reliability Test Items and Conditions

No.	Items	Reference Standard	Test Conditions	Drive Current	Test Duration	Units Failed/Tested
1	Moisture Sensitivity Level	J-STD-020E	$T_{\text{slid}} = 260^{\circ}\text{C}$, 10sec, Precondition: 85°C , 60%RH, 168hr		3 reflows	0/22
2	Low Temperature Storage	JESD22-A119	$T_{\text{a}} = -40^{\circ}\text{C}$		1000 hours	0/22
3	High Temperature Storage	JESD22-A103D	$T_{\text{a}} = 125^{\circ}\text{C}$		1000 hours	0/22
4	Low Temperature Operating Life	JESD22-A108D	$T_{\text{a}} = -40^{\circ}\text{C}$	1400mA	1000 hours	0/22
5	Temperature Humidity Operating Life	JESD22-A101C	$T_{\text{sp}} = 85^{\circ}\text{C}$, RH=85%	1400mA	1000 hours	0/22
6	High Temperature Operating Life	JESD22-A108D	$T_{\text{sp}} = 85^{\circ}\text{C}$	1400mA	1000 hours	0/22
7	Thermal Shock	JESD22-A106B	$T_{\text{a}} = -40^{\circ}\text{C} \sim 125^{\circ}\text{C}$; Dwell : 15min; Transfer: 10sec		200 Cycle	0/22
8	Temperature Cycle	JESD22-A104E	$T_{\text{a}} = -40^{\circ}\text{C} \sim 125^{\circ}\text{C}$; Dwell at extreme temperature: 15min; Ramp rate < $105^{\circ}\text{C}/\text{min}$		200 Cycle	0/22
9	Electrostatic Discharge	JS-001-2012	HBM, 2kV, 15k Ω , 100pF, Alternately positive or negative			0/22
10	Vibration Test	JESD22-B103	$10\text{m}/\text{s}^2$, 100-20000-100Hz 4 cycles, 4min, each X, Y, Z		4 Cycles	0/22

Passing Criteria

Item	Symbol	Test Condition	Passing Criteria
Forward Voltage	Vf	1400mA	$\Delta V_f < 10\%$
Luminous Flux	Iv	1400mA	$\Delta I_v < 30\%$
Chromaticity Coordinates	(x, y)	1400mA	$\Delta u'v' < 0.007$

Notes for Table 9:

1. Test board: Aluminum board thickness -1.0mm, Copper layer thickness-70um.
2. Measurements are performed after allowing the LEDs to return to room temperature
3. T_{slid} : reflow soldering temperature; T_{a} : ambient temperature

Reflowing Characteristics

Figure 12 : Reflow Profile

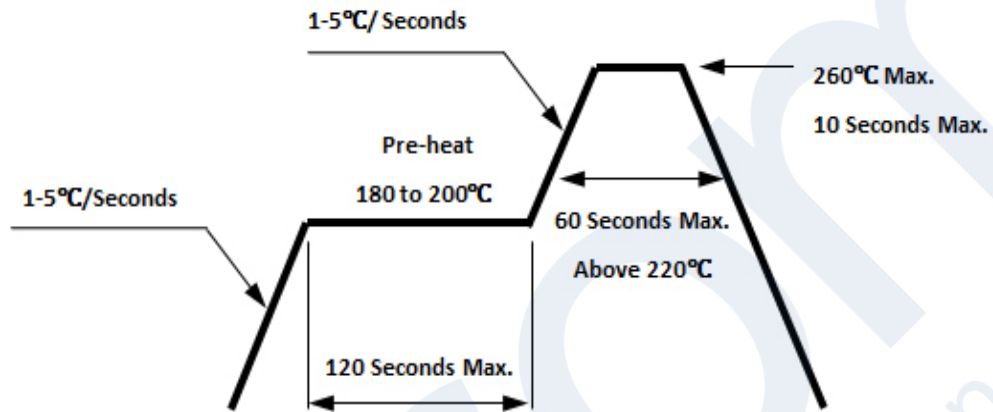

Profile Feature	Lead Free Assembly
Preheat: Temperature Range	180°C – 200°C
Preheat: Time (Maximum)	120 seconds
Peak Temperature	260°C
Soldering Time (Maximum)	10 seconds
Allowable Reflow Cycles	2

Packaging

Figure 13: Reel Drawings

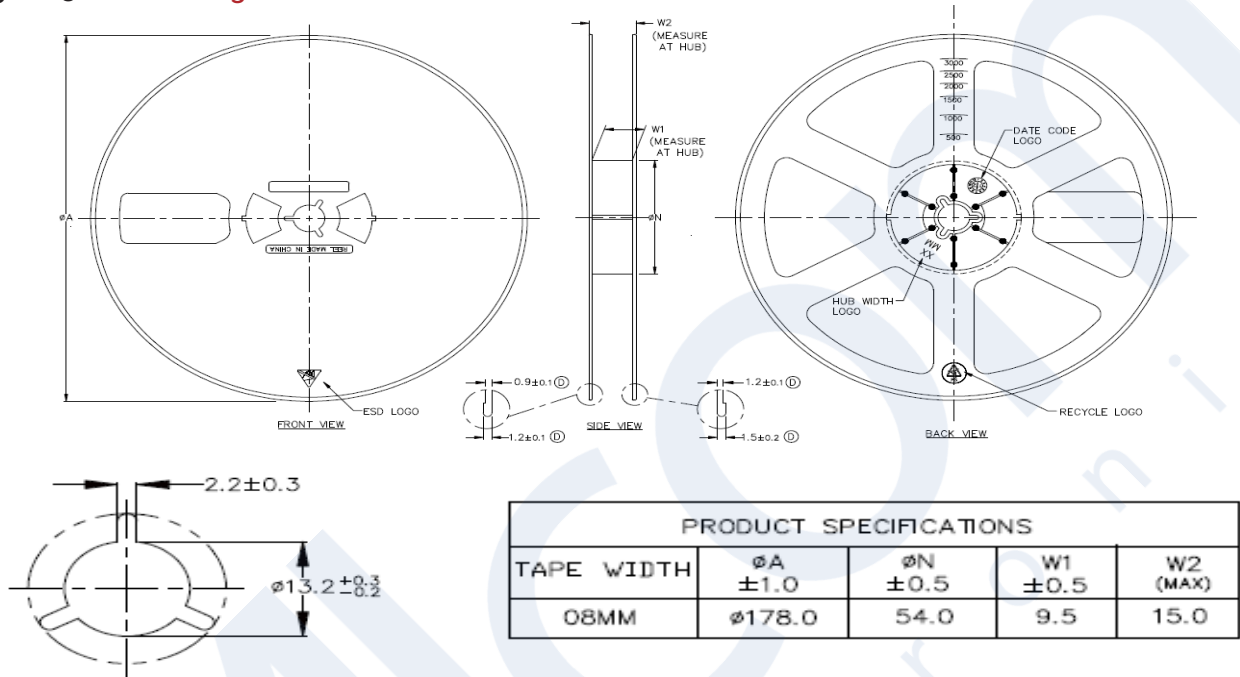

Note for Figure 13:

1. Drawings are not to scale. Drawing dimensions are in millimeters.

Figure 14: Tape Drawings

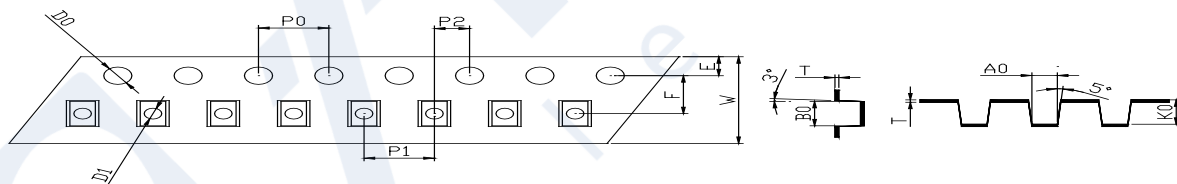

W	T	A0	B0	K0	D0	D1	E	F	P0	P1	P2
8.00±0.05	0.20±0.02	2.50±0.05	2.50±0.05	0.55±0.05	1.60±0.10	1.10±0.10	1.75±0.10	3.50±0.10	4.00±0.10	4.00±0.10	2.00±0.10

Note for Figure 14:

1. Drawings are not to scale. Drawing dimensions are in millimeters.

Packaging

Figure 15: Reel Packaging Drawings

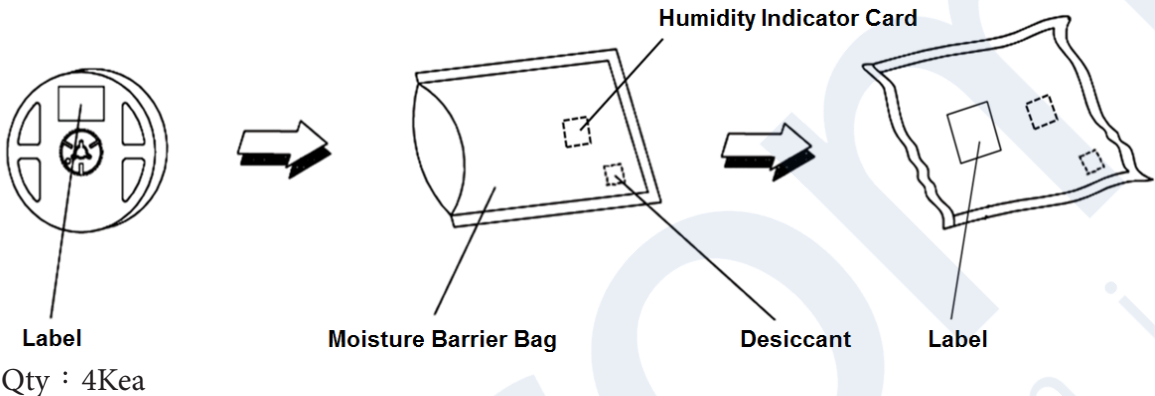

Note for Figure 15:
1. Drawings are not to scale.

Design Resources

Optical Source Models

Please contact your Bridgelux sales representative for assistance.

Precautions

CAUTION: CHEMICAL EXPOSURE HAZARD

Exposure to some chemicals commonly used in luminaire manufacturing and assembly can cause damage to the CSP.

CAUTION: EYE SAFETY

Eye safety classification for the use of Bridgelux CSP is in accordance with IEC specification 62471: Photobiological Safety of Lamps and Lamp Systems. Most of Bridgelux CSPs are classified as Risk Group Exempt or Risk Group 1 in accordance with IEC specification 62471. However, the CSP LEDs will be classified as Risk Group 2 when operated at high power conditions with high ratio blue wavelength in the emission spectrum depending on characteristics. Please use appropriate precautions. It is important that employees working with LEDs are trained to use them safely.

CAUTION: RISK OF BURN

Do not touch the CSP LES during operation. Allow the CSP to cool for a sufficient period of time before handling. The CSP may reach elevated temperatures such that could burn skin when touched.

CAUTION: PICK AND PLACE

Recommend using Teflon material for nozzle. Sharp steel material must not be used as pick up tools.

CAUTION

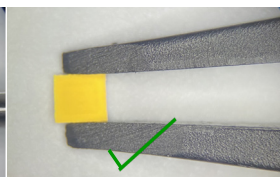
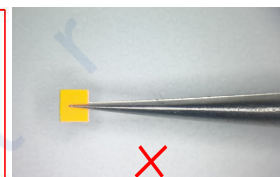
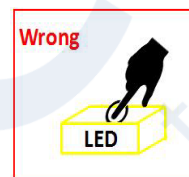

Disclaimers

MINOR PRODUCT CHANGE POLICY

The rigorous qualification testing on products offered by Bridgelux provides performance assurance. Slight cosmetic changes that do not affect form, fit, or function may occur as Bridgelux continues product optimization.

STANDARD TEST CONDITIONS

Unless otherwise stated, LED emitter testing is performed at the nominal drive current.