

# Bridgelux® CSP 1111 Series

Product Data Sheet DS951

# Introduction

CSP 1111

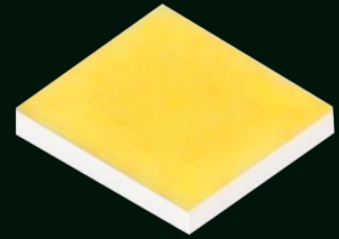

The Bridgelux Chip Scale Package (CSP) 1111 LED offers exceptional performance in an ultra compact size. This CSP LED is hot-color targeted which ensures that the LEDs fall within their specified color bin at the typical application conditions of 85°C. With its superior performance without bonding wires and ability to assemble a densely populated and high luminous flux LED board, the CSP 1111 provides unparalleled design-in flexibility for indoor and outdoor lighting applications. The CSP 1111 is ideal as a drop in replacement for emitters with an industry standard 1.1mm x 1.1mm footprint.

## Features

- Competitive efficacy and lumen per dollar
- Industry-standard 1111 footprint, 1-sided emitter
- Excellent color maintenance
- Compatible with SMT
- Superior luminous flux at maximum current for reduced LED count
- Hot-color targeting ensures that color is within the ANSI bin at the typical application conditions of 85°C
- Enables 3- and 5-step MacAdam ellipse custom binning kits
- 120 degrees viewing angle
- Multiple CCT and CRI configurations for a wide range of lighting applications

## Benefits

- Lower operating and manufacturing cost
- Ease of design and rapid go-to-market
- Uniform consistent white light
- Reliable and constant white point
- Environmentally friendly, complies with standards
- Design flexibility



# Contents

Product Feature Map	2
Product Nomenclature	2
Product Test Conditions	2
Product Selection Guide	3
Performance at Commonly Used Drive Currents	5
Electrical and Thermal Characteristics	7
Absolute Maximum Ratings	8
Product Bin Definitions	9
Performance Curves	12
Typical Radiation Pattern	15
Typical Color Spectrum	16
Mechanical Dimensions	17
Reliability	18
Reflowing Characteristics	19
Packaging	20
Design Resources	22
Precautions	22
Disclaimers	22
About Bridgelux	23

# Product Feature Map

Bridgelux CSP LED products offer exceptional performance and color quality all in a highly reliable, cost effective, compact package. Our CSP products come in industry standard package sizes and follow ANSI binning standards.

These LEDs are optimized for cost and performance, helping to ensure highly competitive system lumen per dollar performance while addressing the stringent efficacy and reliability standards required for modern lighting applications.

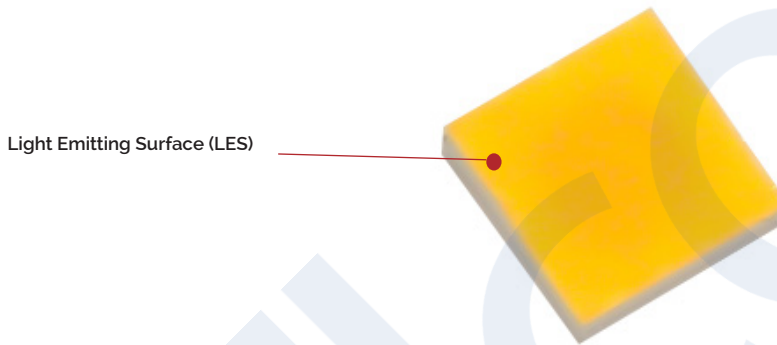

## Product Nomenclature

The part number designation for Bridgelux CSP 1111 is explained as follows:

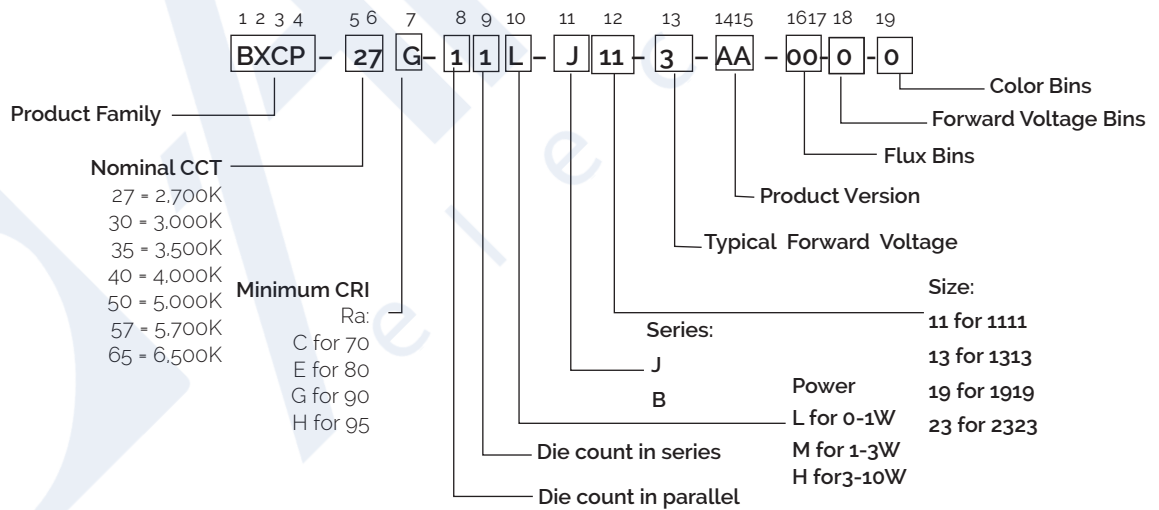

## Product Test Conditions

Bridgelux CSP 1111 LEDs are tested and binned with a 10ms pulse of 350mA at  $T_j$  (junction temperature) =  $T_{sp}$  (solder point temperature) = 85°C. Luminous flux, color and forward voltage are binned at  $T_j = T_{sp} = 85^\circ\text{C}$ .

# Product Selection Guide

The following product configurations are available:

**Table 1:** Selection Guide, Pulsed Measurement Data at 350mA ( $T_j=T_{sp}=25^{\circ}\text{C}$ )

Part Number <sup>1,6</sup>	Nominal CCT <sup>2</sup> (K)	CRI <sup>3,5</sup>	Nominal Drive Current (mA)	Forward Voltage <sup>4,5</sup> (V)			Typical Pulsed Flux <sup>4,5</sup> (lm)	Typical Power (W)	Typical Efficacy (lm/W)
				Min	Typical	Max			
BXCP-27G-11L-J11-3-A1-00-0-0	2700	90	350	2.90	3.10	3.40	100	1.1	92
BXCP-30G-11L-J11-3-A1-00-0-0	3000	90	350	2.90	3.10	3.40	106	1.1	98
BXCP-40G-11L-J11-3-A1-00-0-0	4000	90	350	2.90	3.10	3.40	117	1.1	108
BXCP-50G-11L-J11-3-A1-00-0-0	5000	90	350	2.90	3.10	3.40	117	1.1	108
BXCP-57G-11L-J11-3-A1-00-0-0	5700	90	350	2.90	3.10	3.40	117	1.1	108
BXCP-65G-11L-J11-3-A1-00-0-0	6500	90	350	2.90	3.10	3.40	117	1.1	108
BXCP-27H-11L-J11-3-A1-00-0-0	2700	95	350	2.90	3.10	3.40	90	1.1	83
BXCP-30H-11L-J11-3-A1-00-0-0	3000	95	350	2.90	3.10	3.40	94	1.1	87
BXCP-40H-11L-J11-3-A1-00-0-0	4000	95	350	2.90	3.10	3.40	108	1.1	100
BXCP-50H-11L-J11-3-A1-00-0-0	5000	95	350	2.90	3.10	3.40	108	1.1	100
BXCP-57H-11L-J11-3-A1-00-0-0	5700	95	350	2.90	3.10	3.40	108	1.1	100
BXCP-65H-11L-J11-3-A1-00-0-0	6500	95	350	2.90	3.10	3.40	108	1.1	100

Notes for Table 1:

- The last 6 characters (including hyphens '-') refer to nominal flux, nominal forward voltage, and color bins, respectively. "00-0-0" denotes the full distribution of flux, forward voltage, and 5 SDCM color.  
Example: BXCP-27G-11L-J11-3-A1-00-0-0 refers to the full distribution of flux, forward voltage, and color within a 2700K 5-step ANSI standard chromaticity region with a minimum of 90 CRI.
- Product CCT is hot targeted at  $T_{sp} = 85^{\circ}\text{C}$ . Nominal CCT as defined by ANSI C78.377-2011.
- Listed CRIs are minimum values and include test tolerance.
- Products tested under pulsed condition (10ms pulse width) at nominal drive current where  $T_j=T_{sp}=25^{\circ}\text{C}$ .
- Bridgelux maintains a  $\pm 7.5\%$  tolerance on luminous flux measurements,  $\pm 0.1\text{V}$  tolerance on forward voltage measurements, and  $\pm 2$  tolerance on CRI measurements for the CSP.
- Refer to Table 6 and Table 7 for Bridgelux CSP Luminous Flux Binning and Forward Voltage Binning information.

# Product Selection Guide

**Table 2:** Selection Guide, Pulsed Measurement Data at 350mA ( $T_j = T_{sp} = 85^\circ\text{C}$ )

Part Number <sup>1,5</sup>	Nominal CCT <sup>2</sup> (K)	CRI <sup>3,4</sup>	Nominal Drive Current (mA)	Forward Voltage <sup>4</sup> (V)			Typical Pulsed Flux <sup>4</sup> (lm)	Typical Power (W)	Typical Efficacy (lm/W)
				Min	Typical	Max			
BXCP-27G-11L-J11-3-A1-00-0-0	2700	90	350	2.80	3.00	3.20	90	11	86
BXCP-30G-11L-J11-3-A1-00-0-0	3000	90	350	2.80	3.00	3.20	95	11	90
BXCP-40G-11L-J11-3-A1-00-0-0	4000	90	350	2.80	3.00	3.20	105	11	100
BXCP-50G-11L-J11-3-A1-00-0-0	5000	90	350	2.80	3.00	3.20	105	11	100
BXCP-57G-11L-J11-3-A1-00-0-0	5700	90	350	2.80	3.00	3.20	105	11	100
BXCP-65G-11L-J11-3-A1-00-0-0	6500	90	350	2.80	3.00	3.20	105	11	100
BXCP-27H-11L-J11-3-A1-00-0-0	2700	95	350	2.80	3.00	3.20	81	11	77
BXCP-30H-11L-J11-3-A1-00-0-0	3000	95	350	2.80	3.00	3.20	85	11	81
BXCP-40H-11L-J11-3-A1-00-0-0	4000	95	350	2.80	3.00	3.20	97	11	92
BXCP-50H-11L-J11-3-A1-00-0-0	5000	95	350	2.80	3.00	3.20	97	11	92
BXCP-57H-11L-J11-3-A1-00-0-0	5700	95	350	2.80	3.00	3.20	97	11	92
BXCP-65H-11L-J11-3-A1-00-0-0	6500	95	350	2.80	3.00	3.20	97	11	92

Notes for Table 2:

- The last 6 characters (including hyphens '-') refer to nominal flux, nominal forward voltage, and color bins, respectively. "00-0-0" denotes the full distribution of flux, forward voltage, and 5 SDCM color.  
Example: BXCP-27G-11L-J11-3-A1-00-0-0 refers to the full distribution of flux, forward voltage, and color within a 2700K 5-step ANSI standard chromaticity region with a minimum of 90 CRI.
- Product CCT is hot targeted at  $T_{sp} = 85^\circ\text{C}$ . Nominal CCT as defined by ANSI C78.377-2011.
- Listed CRIs are minimum values and include test tolerance.
- Bridgelux maintains a  $\pm 7.5\%$  tolerance on luminous flux measurements,  $\pm 0.1\text{V}$  tolerance on forward voltage measurements, and  $\pm 2$  tolerance on CRI measurements for the CSP.
- Refer to Table 6 and Table 7 for Bridgelux CSP Luminous Flux Binning and Forward Voltage Binning information.
- Products tested under pulsed condition (10ms pulse width) at nominal drive current where  $T_j = T_{sp} = 85^\circ\text{C}$ .

# Performance at Commonly Used Drive Currents

CSP 1111 LEDs are tested to the specifications shown using the nominal drive currents in Table 1. CSP 1111 may also be driven at other drive currents dependent on specific application design requirements. The performance at any drive current can be derived from the current vs. voltage characteristics shown in Figure 2 and the relative luminous flux vs. current characteristics shown in Figure 3. The performance at commonly used drive currents is summarized in Table 3.

**Table 3:** Performance at Commonly Used Drive Currents

Part Number	CRI	Drive Current <sup>1</sup> (mA)	Typical $V_f$ $T_{sp} = 25^\circ\text{C}$ (V)	Typical Power $T_{sp} = 25^\circ\text{C}$ (W)	Typical Pulsed Flux <sup>2</sup> $T_{sp} = 25^\circ\text{C}$ (lm)	Typical Pulsed Flux <sup>3</sup> $T_{sp} = 85^\circ\text{C}$ (lm)	Typical Efficacy $T_{sp} = 25^\circ\text{C}$ (lm/W)
BXCP-27G-11L-J11-3-A1-00-0-0	90	50	2.7	0.1	19	17	139
		150	2.9	0.4	51	46	117
		250	3.0	0.8	77	70	102
		<b>350</b>	<b>3.1</b>	<b>1.1</b>	<b>100</b>	<b>90</b>	<b>92</b>
		400	3.2	1.3	111	100	87
		500	3.3	1.7	131	118	79
BXCP-30G-11L-J11-3-A1-00-0-0	90	50	2.7	0.1	20	18	147
		150	2.9	0.4	54	48	124
		250	3.0	0.8	82	73	108
		<b>350</b>	<b>3.1</b>	<b>1.1</b>	<b>106</b>	<b>95</b>	<b>98</b>
		400	3.2	1.3	117	105	91
		500	3.3	1.7	138	124	83
BXCP-40G-11L-J11-3-A1-00-0-0	90	50	2.7	0.1	22	20	162
		150	2.9	0.4	59	53	137
		250	3.0	0.8	90	81	119
		<b>350</b>	<b>3.1</b>	<b>1.1</b>	<b>117</b>	<b>105</b>	<b>108</b>
		400	3.2	1.3	129	116	101
		500	3.3	1.7	152	137	92
BXCP-50G-11L-J11-3-A1-00-0-0	90	50	2.7	0.1	22	20	162
		150	2.9	0.4	59	53	137
		250	3.0	0.8	90	81	119
		<b>350</b>	<b>3.1</b>	<b>1.1</b>	<b>117</b>	<b>105</b>	<b>108</b>
		400	3.2	1.3	129	116	101
		500	3.3	1.7	152	137	92
BXCP-57G-11L-J11-3-A1-00-0-0	90	50	2.7	0.1	22	20	162
		150	2.9	0.4	59	53	137
		250	3.0	0.8	90	81	119
		<b>350</b>	<b>3.1</b>	<b>1.1</b>	<b>117</b>	<b>105</b>	<b>108</b>
		400	3.2	1.3	129	116	101
		500	3.3	1.7	152	137	92
BXCP-65G-11L-J11-3-A1-00-0-0	90	50	2.7	0.1	22	20	162
		150	2.9	0.4	59	53	137
		250	3.0	0.8	90	81	119
		<b>350</b>	<b>3.1</b>	<b>1.1</b>	<b>117</b>	<b>105</b>	<b>108</b>
		400	3.2	1.3	129	116	101
		500	3.3	1.7	152	137	92

Notes for Table 3:

1. Alternate drive currents in Table 3 are provided for reference only and are not a guarantee of performance.
2. Bridgelux maintains a  $\pm 7.5\%$  tolerance on flux measurements.
3. Typical pulsed performance values are provided as reference only and are not a guarantee of performance.

# Performance at Commonly Used Drive Currents

**Table 3:** Performance at Commonly Used Drive Currents (Continued)

Part Number	CRI	Drive Current <sup>1</sup> (mA)	Typical $V_f$ $T_{sp} = 25^\circ\text{C}$ (V)	Typical Power $T_{sp} = 25^\circ\text{C}$ (W)	Typical Pulsed Flux <sup>2</sup> $T_{sp} = 25^\circ\text{C}$ (lm)	Typical Pulsed Flux <sup>3</sup> $T_{sp} = 85^\circ\text{C}$ (lm)	Typical Efficacy $T_{sp} = 25^\circ\text{C}$ (lm/W)
BXCP-27H-11L-J11-3-A1-00-0-0	95	50	2.7	0.1	17	15	125
		150	2.9	0.4	46	41	106
		250	3.0	0.8	70	63	92
		<b>350</b>	<b>3.1</b>	<b>1.1</b>	<b>90</b>	<b>81</b>	<b>83</b>
		400	3.2	1.3	100	90	78
		500	3.3	1.7	118	106	71
BXCP-30H-11L-J11-3-A1-00-0-0	95	50	2.7	0.1	18	16	131
		150	2.9	0.4	48	43	111
		250	3.0	0.8	73	66	97
		<b>350</b>	<b>3.1</b>	<b>1.1</b>	<b>94</b>	<b>85</b>	<b>87</b>
		400	3.2	1.3	105	94	82
		500	3.3	1.7	123	111	75
BXCP-40H-11L-J11-3-A1-00-0-0	95	50	2.7	0.1	20	18	150
		150	2.9	0.4	55	49	126
		250	3.0	0.8	83	75	110
		<b>350</b>	<b>3.1</b>	<b>1.1</b>	<b>108</b>	<b>97</b>	<b>100</b>
		400	3.2	1.3	119	107	93
		500	3.3	1.7	141	127	85
BXCP-50H-11L-J11-3-A1-00-0-0	95	50	2.7	0.1	20	18	150
		150	2.9	0.4	55	49	126
		250	3.0	0.8	83	75	110
		<b>350</b>	<b>3.1</b>	<b>1.1</b>	<b>108</b>	<b>97</b>	<b>100</b>
		400	3.2	1.3	119	107	93
		500	3.3	1.7	141	127	85
BXCP-57H-11L-J11-3-A1-00-0-0	95	50	2.7	0.1	20	18	150
		150	2.9	0.4	55	49	126
		250	3.0	0.8	83	75	110
		<b>350</b>	<b>3.1</b>	<b>1.1</b>	<b>108</b>	<b>97</b>	<b>100</b>
		400	3.2	1.3	119	107	93
		500	3.3	1.7	141	127	85
BXCP-65H-11L-J11-3-A1-00-0-0	95	50	2.7	0.1	20	18	150
		150	2.9	0.4	55	49	126
		250	3.0	0.8	83	75	110
		<b>350</b>	<b>3.1</b>	<b>1.1</b>	<b>108</b>	<b>97</b>	<b>100</b>
		400	3.2	1.3	119	107	93
		500	3.3	1.7	141	127	85

Notes for Table 3:

1. Alternate drive currents in Table 3 are provided for reference only and are not a guarantee of performance.
2. Bridgelux maintains a  $\pm 7.5\%$  tolerance on flux measurements.
3. Typical pulsed performance values are provided as reference only and are not a guarantee of performance.



# Electrical and Thermal Characteristics

**Table 4: Electrical and Thermal Characteristics**

Part Number <sup>1</sup>	Drive Current (mA)	Forward Voltage <sup>2,3</sup> (V)			Typical Temperature Coefficient of Forward Voltage <sup>4</sup> $\Delta V_f / \Delta T$ (mV/°C)	Typical Thermal Resistance Junction to Solder Point <sup>5,6</sup> $R_{j-sp}$ (°C/W)
		Minimum	Typical	Maximum		
BXCP-XXX-11L-J11-3-A1-00-0-0	350	2.80	3.00	3.20	-17	9.5

Notes for Table 4:

1. The last 6 characters (including hyphens '-') refer to nominal flux, nominal forward voltage, and color bins, respectively. "00-0-0" denotes the full distribution of flux, forward voltage, and 5 SDCM color.

Example: BXCP-27G-11L-J11-3-A1-00-0-0 refers to the full distribution of flux, forward voltage, and color within a 2700K 5-step ANSI standard chromaticity region with a minimum of 90 CRI.

2. Products tested under pulsed condition (10ms pulse width) at nominal drive current where  $T_{sp} = 85^{\circ}\text{C}$ .

3. Bridgelux maintains a tolerance of  $\pm 0.1\text{V}$  on forward voltage measurements.

4. Products measured between  $25^{\circ}\text{C}$  and  $105^{\circ}\text{C}$  at nominal drive current (10ms pulse width).

5. Thermal Resistance values based on 2700K 90 CRI product.

6. Thermal resistance value was calculated using total electrical input power; optical power was not subtracted from input power.

# Absolute Maximum Ratings

**Table 5:** Maximum Ratings

Parameter	Maximum Rating
LED Junction Temperature ( $T_j$ )	135°C
Storage Temperature	-40°C to +125°C
Operating Solder Point Temperature ( $T_{sp}$ )	-40°C to +105°C
Soldering Temperature	260°C or lower for a maximum of 10 seconds
Maximum Drive Current	500mA
Maximum Peak Pulsed Forward Current <sup>1</sup>	1000mA
Maximum Reverse Voltage <sup>2</sup>	-5V
Moisture Sensitivity Rating	MSL 3
Electrostatic Discharge	2kV HBM. JEDEC-JS-001-HBM and JEDEC-JS-001-2012

Notes for Table 5:

1. Bridgelux recommends a maximum duty cycle of 10% and pulse width of 10 ms when operating CSP LED at maximum peak pulsed current specified. Maximum peak pulsed currents indicate values where CSP LED can be driven without catastrophic failures.
2. Light emitting diodes are not designed to be driven in reverse voltage and will not produce light under this condition. Maximum rating provided for reference only.

# Product Bin Definitions

Table 6 lists the standard photometric luminous flux bins for Bridgelux CSP 1111 LEDs. Although several bins are outlined, product availability in a particular bin varies by production run and by product performance. Not all bins are available in all CCTs.

**Table 6:** Luminous Flux Bin Definitions at 350mA,  $T_{sp}=85^{\circ}\text{C}$

Bin Code	Minimum	Maximum	Unit	Condition
E1	70	80	lm	$I_F=350\text{mA}$
F1	80	90		
G1	90	100		
H1	100	110		
I1	110	120		
J1	120	130		

Note for Table 6:

1. Bridgelux maintains a tolerance of  $\pm 7.5\%$  on luminous flux measurements.

**Table 7:** Forward Voltage Bin Definition at 350mA,  $T_{sp}=85^{\circ}\text{C}$

Bin Code	Minimum	Maximum	Unit	Condition
D	2.8	3.0	V	$I_F=350\text{mA}$
E	3.0	3.2		
F	3.2	3.4		

Note for Table 7:

1. Bridgelux maintains a tolerance of  $\pm 0.1\text{V}$  on forward voltage measurements.

# Product Bin Definitions

**Table 8:** 3- and 5-step MacAdam Ellipse Color Bin Definitions ( $T_{sp}=85^{\circ}\text{C}$ )

Table 8: 3- and 5-step MacAdam Ellipse Color Bin Definitions ( $T_{sp}=85^{\circ}\text{C}$ )							
CCT	Color Space	Center Point		Major Axis	minor Axis	$\theta'$ (angle)	Color Bin <sup>(2,3)</sup>
		x	y				
2700K	2	0.4578	0.4101	0.0054	0.0028	53.70	2
	3			0.0081	0.0042		3
	5			0.0135	0.0070		5(E/F/G/H)
3000K	2	0.4338	0.4030	0.0056	0.0027	53.22	2
	3			0.0083	0.0041		3
	5			0.0139	0.0068		5(E/F/G/H)
3500K	2	0.4073	0.3917	0.0062	0.0028	54.00	2
	3			0.0093	0.0041		3
	5			0.0155	0.0069		5(E/F/G/H)
4000K	2	0.3818	0.3797	0.0063	0.0027	53.72	2
	3			0.0094	0.0040		3
	5			0.0157	0.0067		5(E/F/G/H)
5000K	2	0.3447	0.3553	0.0055	0.0024	59.62	2
	3			0.0082	0.0035		3
	5			0.0137	0.0059		5(E/F/G/H)
5700K	2	0.3287	0.3417	0.0050	0.0021	59.09	2
	3			0.0075	0.0032		3
	5			0.0124	0.0053		5(E/F/G/H)
6500K	2	0.3123	0.3282	0.0045	0.0019	58.57	2
	3			0.0067	0.0029		3
	5			0.0112	0.0048		5(E/F/G/H)

Note for Table 8:

1. Bridgelux maintains a tolerance of  $\pm 0.007$  on x and y color coordinates in the CIE 1931 color space.
2. MacAdam Ellipse Color bin code for  $\text{CRI} \geq 90$ : 2(2 SDCM)/ 3(3 SDCM)/ EFGH(5 SDCM).
3. MacAdam Ellipse Color bin code for  $\text{CRI} < 90$ : 3(3 SDCM)/ 5(5 SDCM).

# Product Bin Definitions

Figure 1: C.I.E. 1931 Chromaticity Diagram (Color Bin Structure,  $T_{sp}=85^{\circ}\text{C}$ )

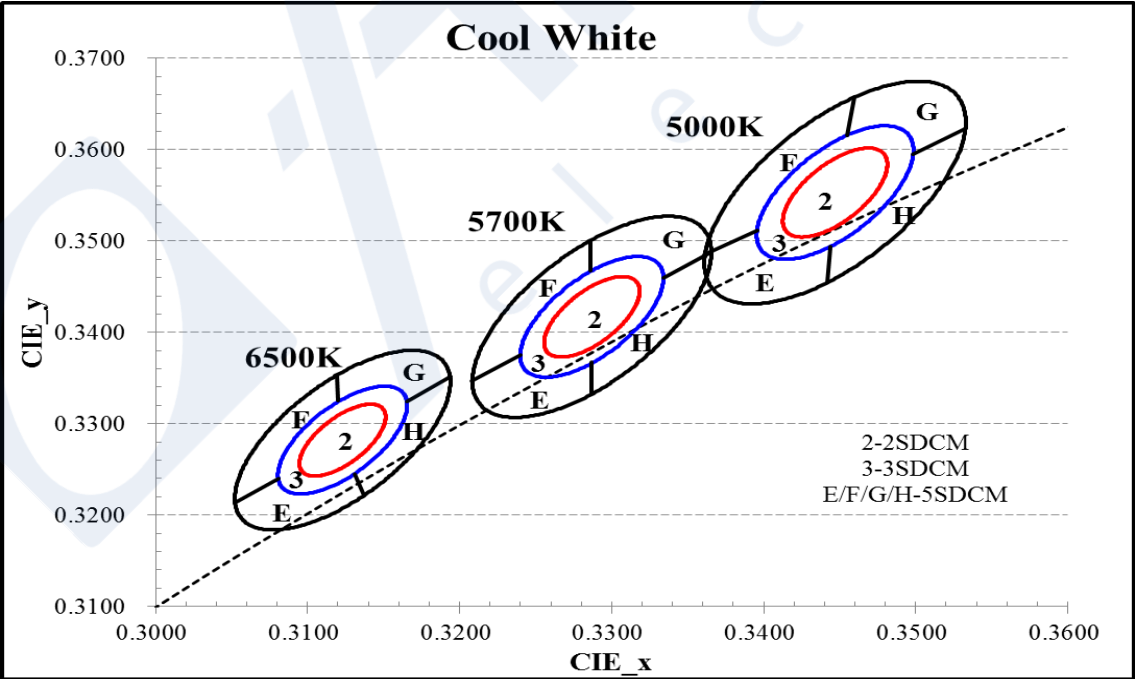
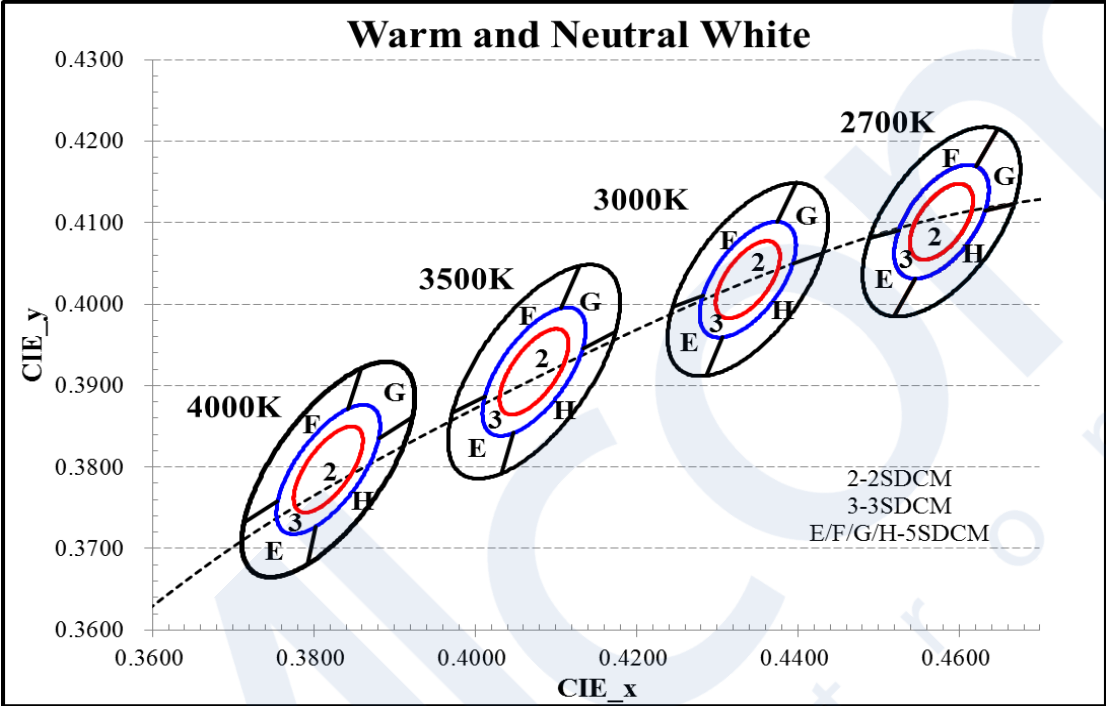

# Performance Curves

Figure 2: Drive Current vs. Voltage ( $T_{sp}=85^{\circ}\text{C}$ )

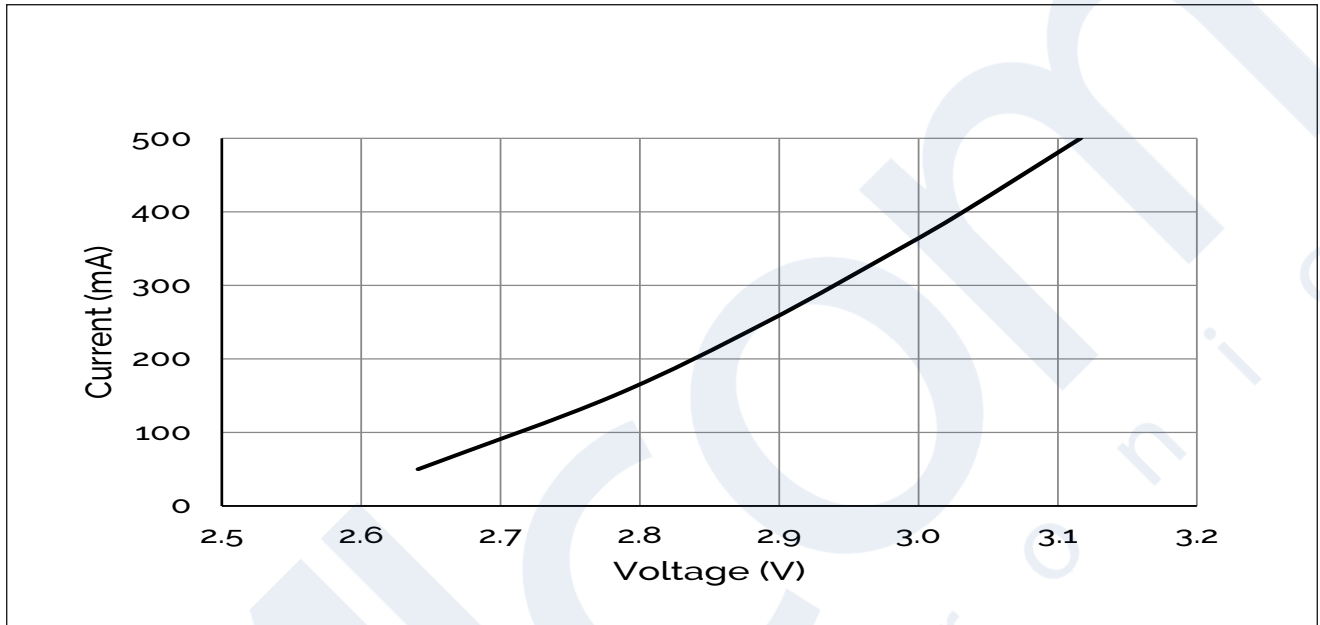
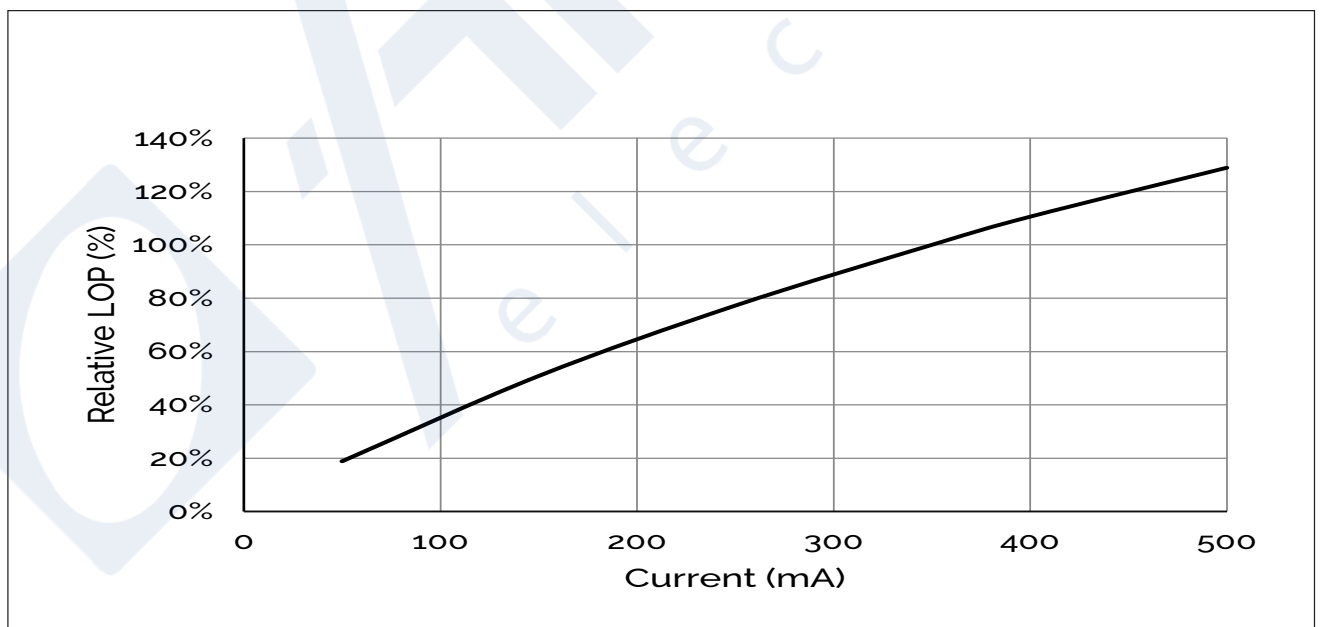

Figure 3: Typical Relative Luminous Flux vs. Drive Current ( $T_{sp}=85^{\circ}\text{C}$ )



Note for Figure 3:

1. Bridgelux does not recommend driving high power LEDs at low current (< 10mA). Doing so may produce unpredictable results. Pulse width modulation (PWM) is recommended for dimming effects.

# Performance Curves

Figure 4: Typical Relative Flux vs. Solder Point Temperature\_350mA

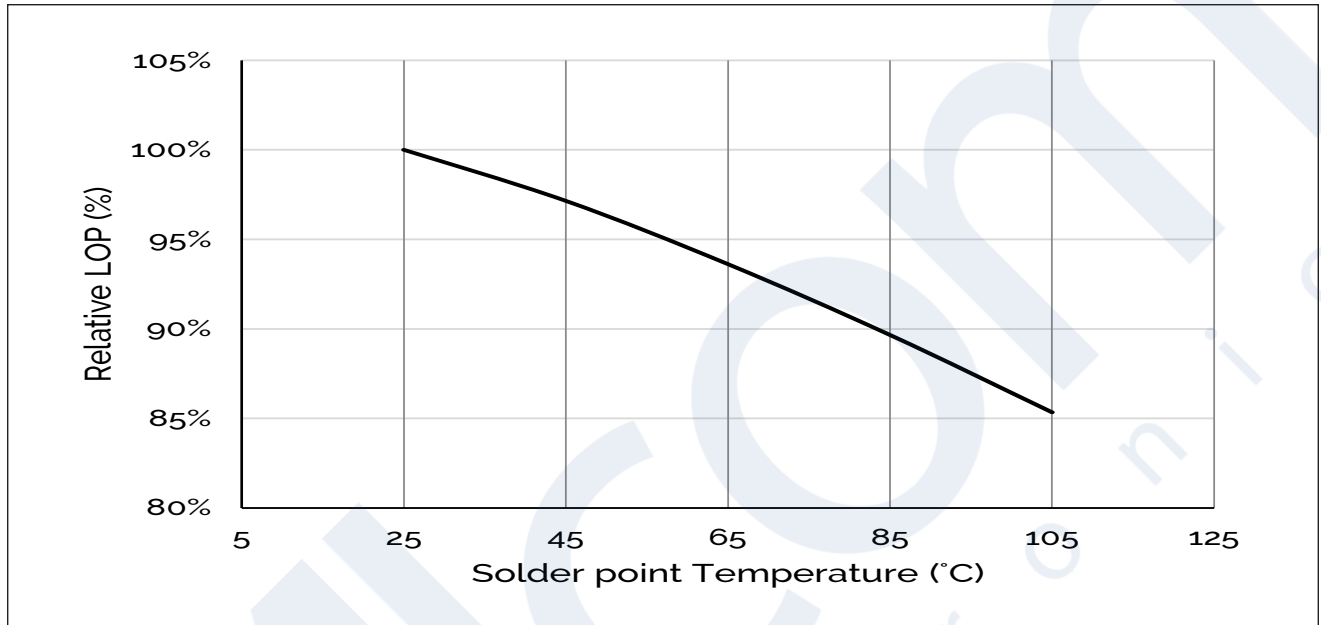
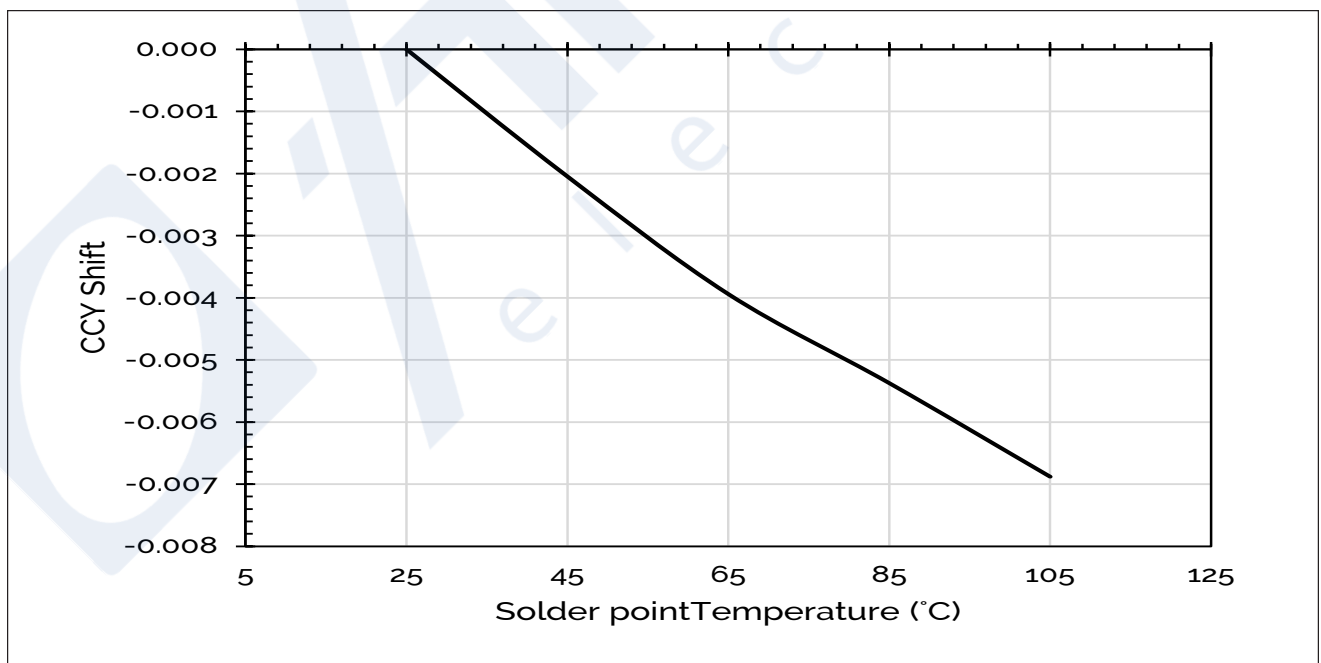

Figure 5: Typical ccY Shift vs. Solder Point Temperature\_350mA



Notes for Figures 4 & 5:

- 1.Characteristics shown for warm white based on 2700K and 90 CRI.
2. For other color SKUs, the shift in color will vary. Please contact your Bridgelux Sales Representative for more information.

# Performance Curves

Figure 6: Typical ccx Shift vs. Solder Point Temperature\_350mA

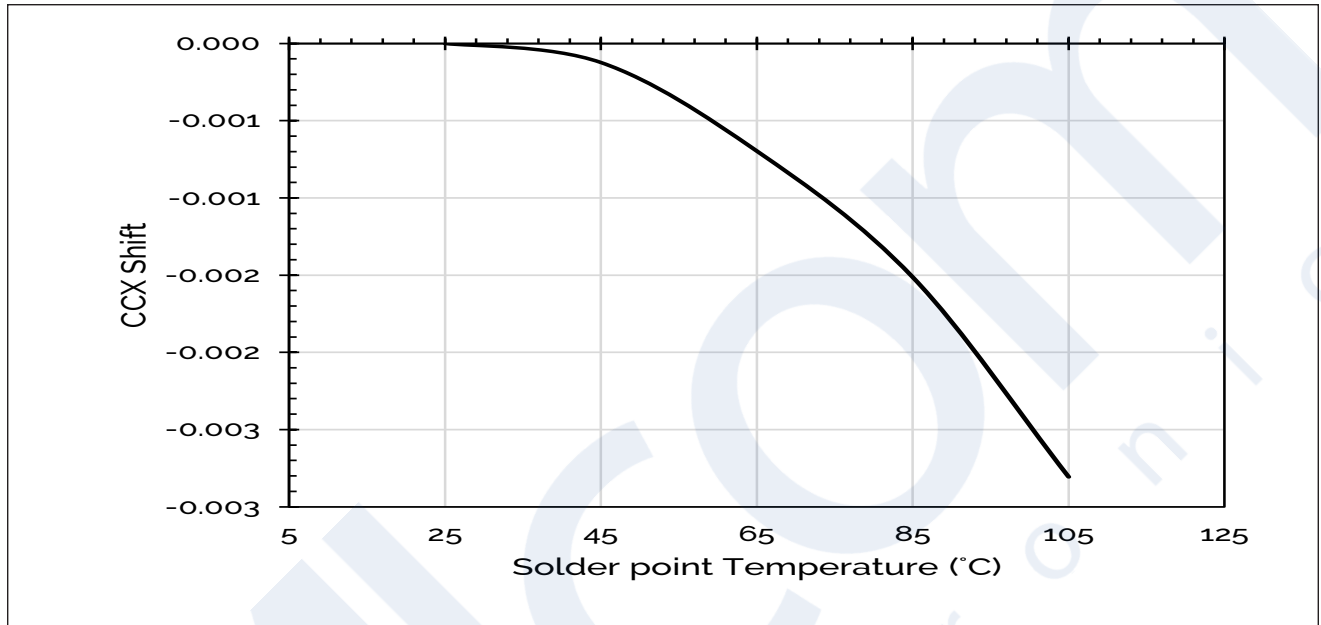

Notes for Figure 6:

1. Characteristics shown for warm white based on 2700K and 90 CRI.
2. For other color SKUs, the shift in color will vary. Please contact your Bridgelux Sales Representative for more information.

Figure 7: Drive Current vs Solder Point Temperature

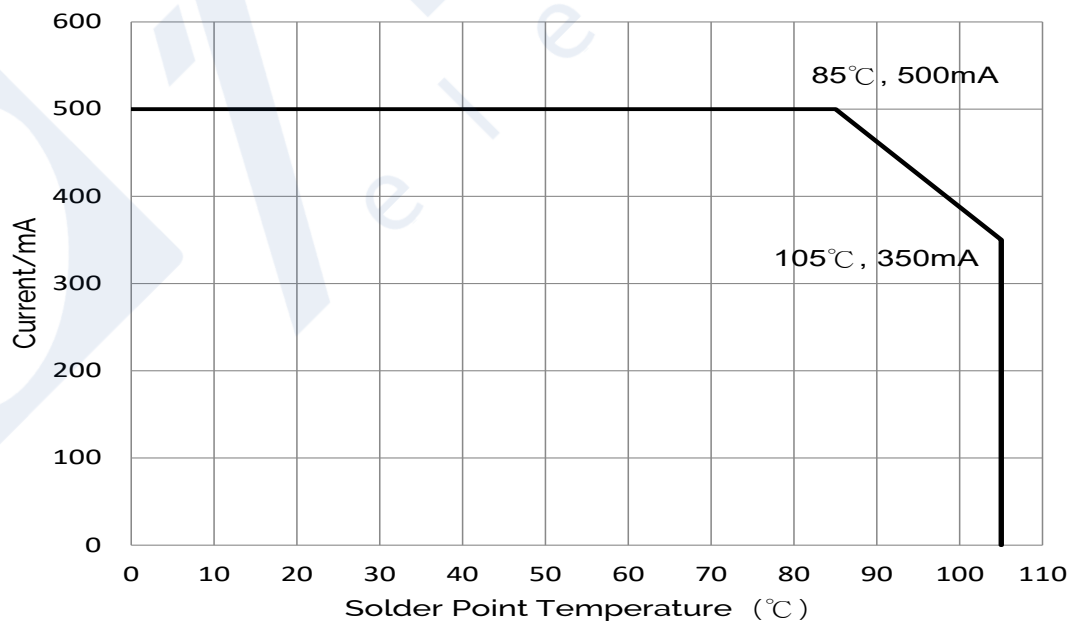



# Typical Radiation Pattern

Figure 8: Typical Spatial Radiation Pattern at 350mA,  $T_{sp} = 25^{\circ}\text{C}$

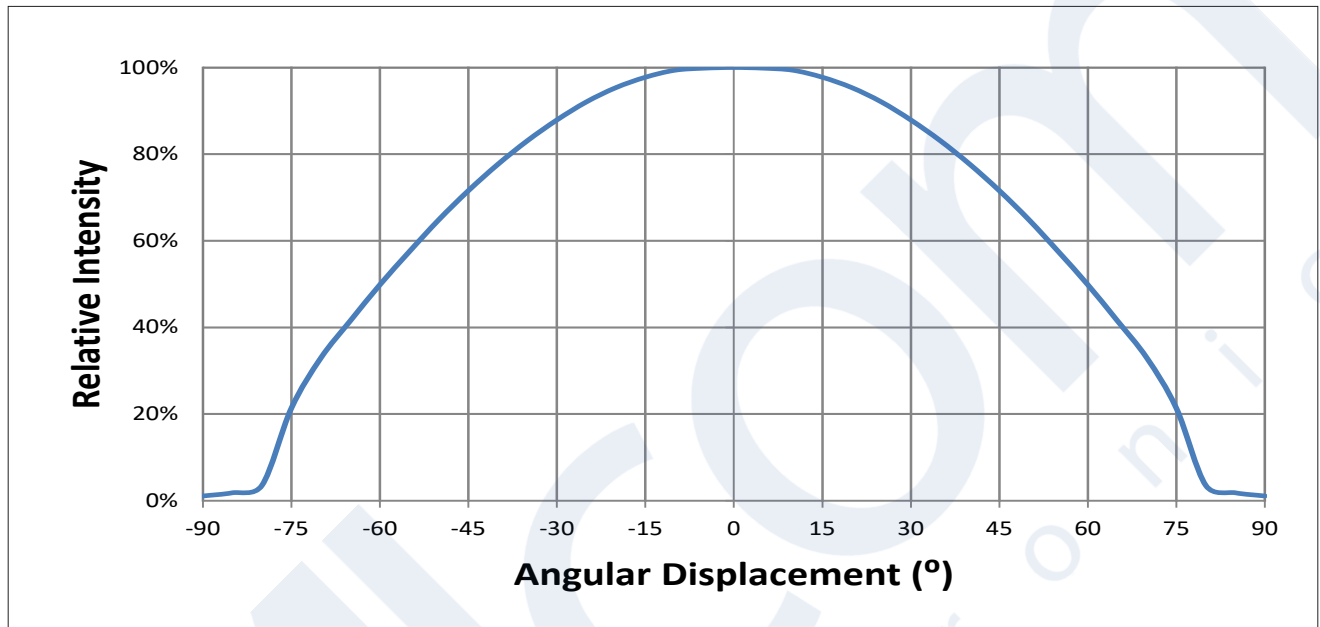

Notes for Figure 8:

1. Typical viewing angle is  $120^{\circ}$ .
2. The viewing angle is defined as the off axis angle from the centerline where  $I_v$  is  $\frac{1}{2}$  of the peak value.

Figure 9: Typical Polar Radiation Pattern at 350mA,  $T_{sp} = 25^{\circ}\text{C}$

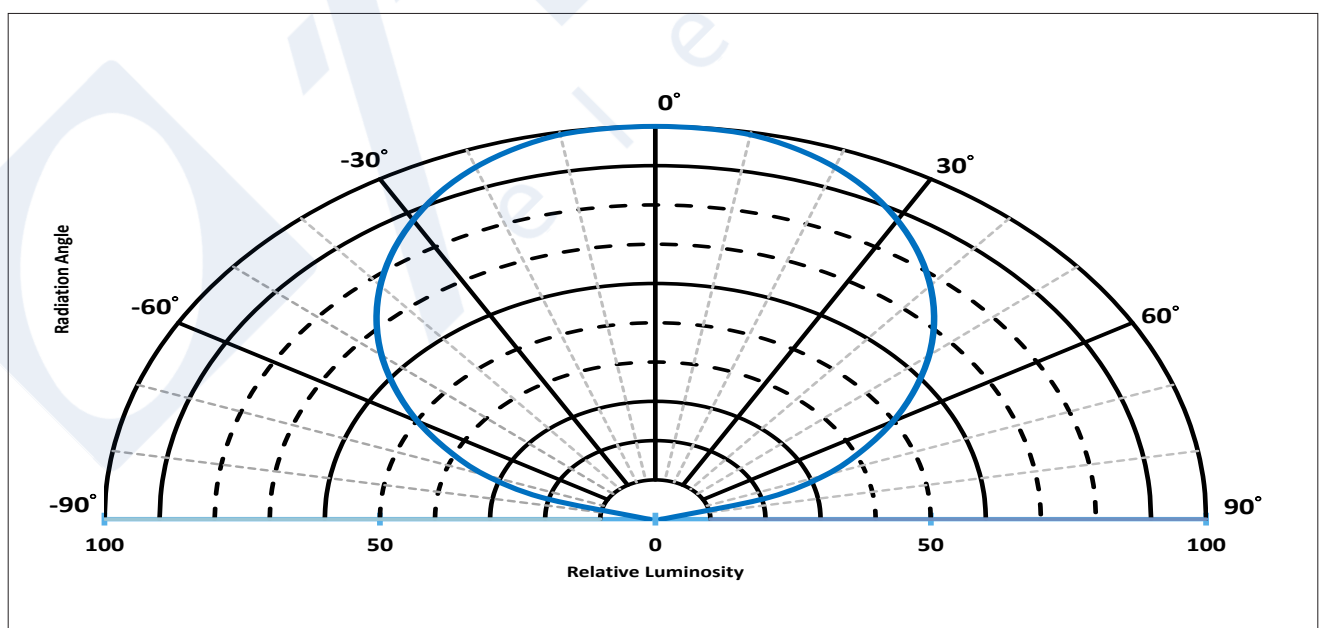

# Typical Color Spectrum

Figure 10: Typical Color Spectrum

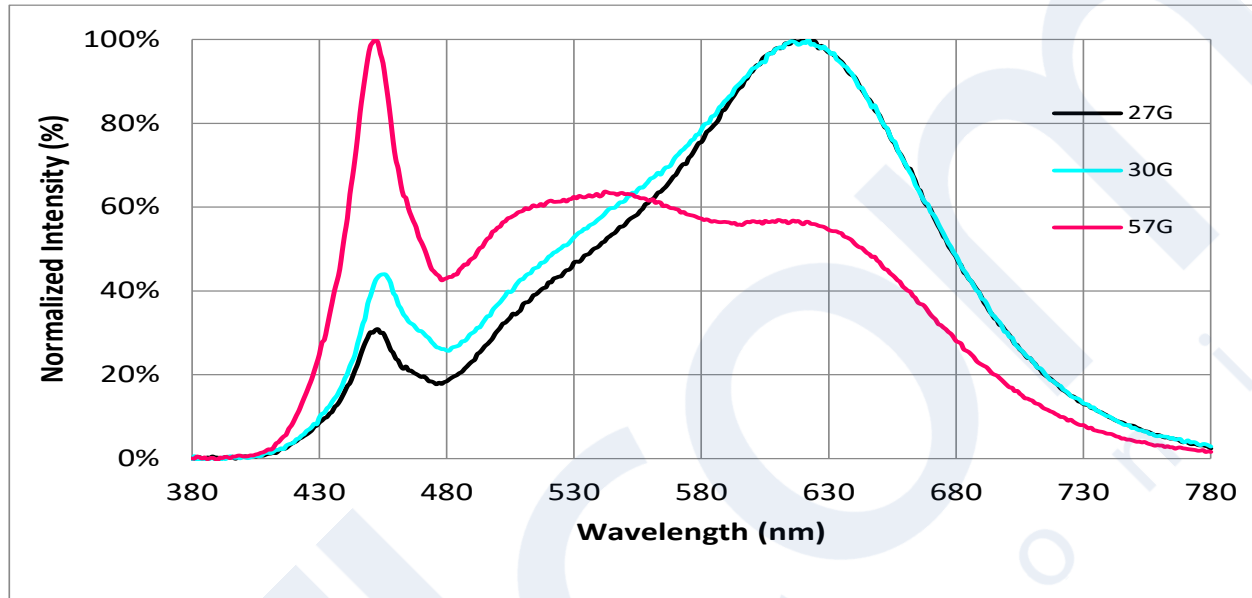

Notes for Figure 10:

1. Color spectra measured at nominal current for  $T_{sp} = 85^{\circ}\text{C}$
2. Color spectra shown for warm white is 2700K and 90 CRI.
3. Color spectra shown for warm white is 3000K and 90 CRI.
4. Color spectra shown for cool white is 5700K and 90 CRI.

# Mechanical Dimensions

Figure 11: Drawing for CSP 1111

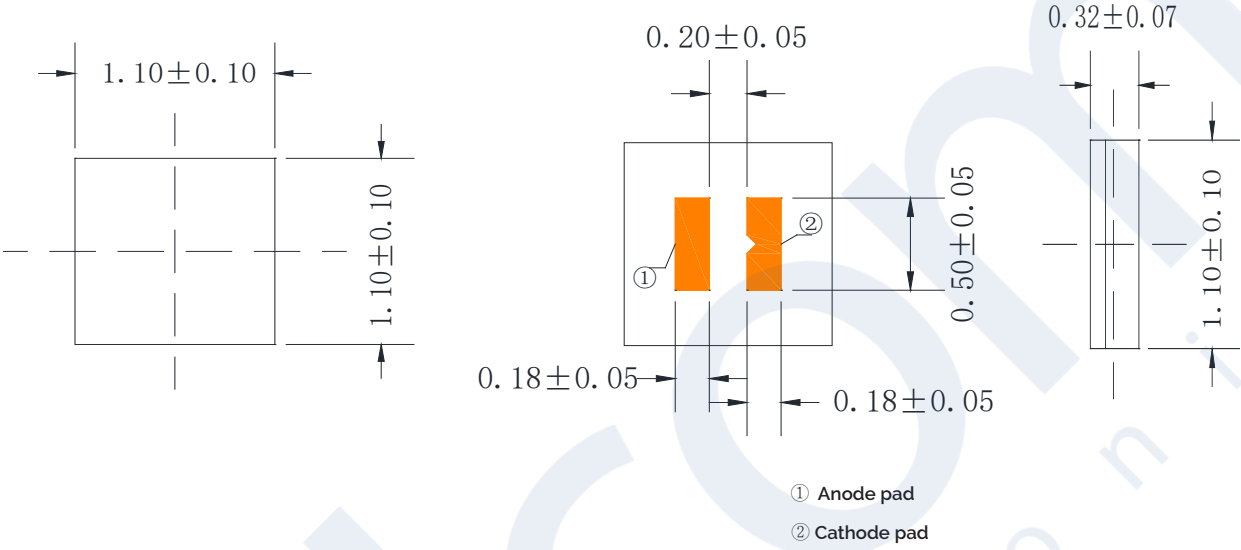

Notes for Figure 11:

1. Drawings are not to scale.
2. Drawing dimensions are in millimeters.
3. Unless otherwise specified, tolerances are  $\pm 0.10$ mm.
4. The optical center of the LED emitter is nominally defined by the mechanical center of the emitter. The light emitting surface (LES) is centered on the mechanical center of the LED emitter to a tolerance of  $\pm 0.2$  mm

## Recommended PCB Soldering Pad Pattern

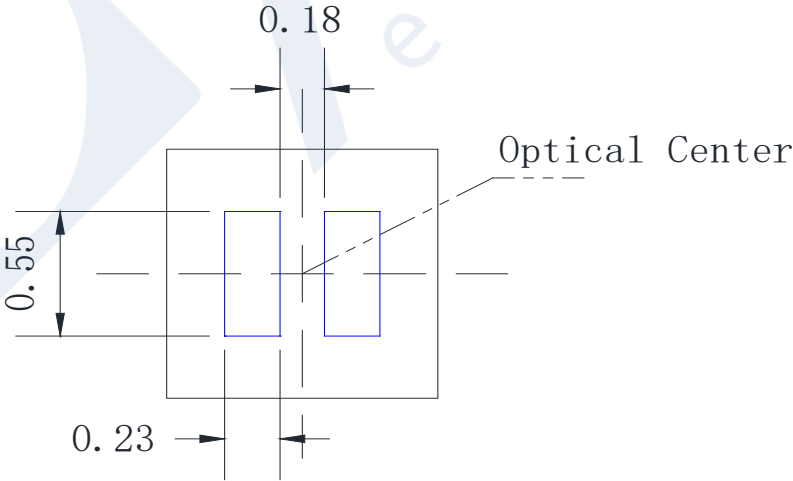

# Reliability

**Table 9: Reliability Test Items and Conditions**

No.	Items	Reference Standard	Test Conditions	Drive Current	Test Duration	Units Failed/Tested
1	Moisture Sensitivity Level	J-STD-020E	$T_{\text{slid}} = 260^{\circ}\text{C}$ , 10sec, Precondition: $85^{\circ}\text{C}$ , 60%RH, 168hr		3 reflows	0/22
2	Low Temperature Storage	JESD22-A119	$T_{\text{a}} = -40^{\circ}\text{C}$		1000 hours	0/22
3	High Temperature Storage	JESD22-A103D	$T_{\text{a}} = 125^{\circ}\text{C}$		1000 hours	0/22
4	Low Temperature Operating Life	JESD22-A108D	$T_{\text{a}} = -40^{\circ}\text{C}$	500mA	1000 hours	0/22
5	Temperature Humidity Operating Life	JESD22-A101C	$T_{\text{sp}} = 85^{\circ}\text{C}$ , RH=85%	500mA	1000 hours	0/22
6	High Temperature Operating Life	JESD22-A108D	$T_{\text{sp}} = 85^{\circ}\text{C}$	500mA	1000 hours	0/22
7	Thermal Shock	JESD22-A106B	$T_{\text{a}} = -40^{\circ}\text{C} \sim 125^{\circ}\text{C}$ ; Dwell : 15min; Transfer: 10sec		200 Cycle	0/22
8	Temperature Cycle	JESD22-A104E	$T_{\text{a}} = -40^{\circ}\text{C} \sim 125^{\circ}\text{C}$ ; Dwell at extreme temperature: 15min; Ramp rate < $105^{\circ}\text{C}/\text{min}$		200 Cycle	0/22
9	Electrostatic Discharge	JS-001-2012	HBM, 2kV, 15k $\Omega$ , 100pF, Alternately positive or negative			0/22
10	Vibration Test	JESD22-B103	10m/s <sup>2</sup> , 100-20000-100Hz 4 cycles,4min,eachX,Y,Z		4 Cycles	0/22

## Passing Criteria

Item	Symbol	Test Condition	Passing Criteria
Forward Voltage	Vf	500mA	$\Delta V_f < 10\%$
Luminous Flux	Iv	500mA	$\Delta I_v < 30\%$
Chromaticity Coordinates	(x, y)	500mA	$\Delta u'v' < 0.007$

Notes for Table 9:

1. Test board: Aluminum board thickness -1.0mm, Copper layer thickness-70um.
2. Measurements are performed after allowing the LEDs to return to room temperature
3.  $T_{\text{slid}}$ : reflow soldering temperature;  $T_{\text{a}}$ : ambient temperature

# Reflowing Characteristics

Figure 12 : Reflow Profile

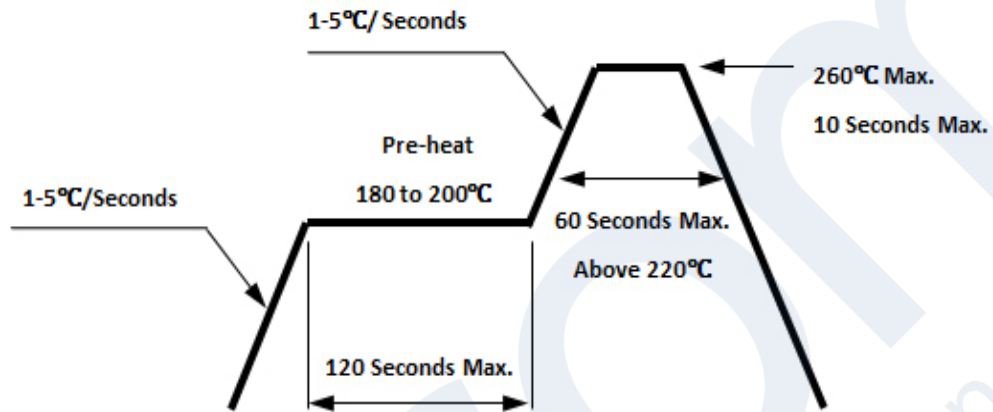

Profile Feature	Lead Free Assembly
Preheat: Temperature Range	180°C – 200°C
Preheat: Time (Maximum)	120 seconds
Peak Temperature	260°C
Soldering Time (Maximum)	10 seconds
Allowable Reflow Cycles	2



# Packaging

Figure 15: Reel Packaging Drawings

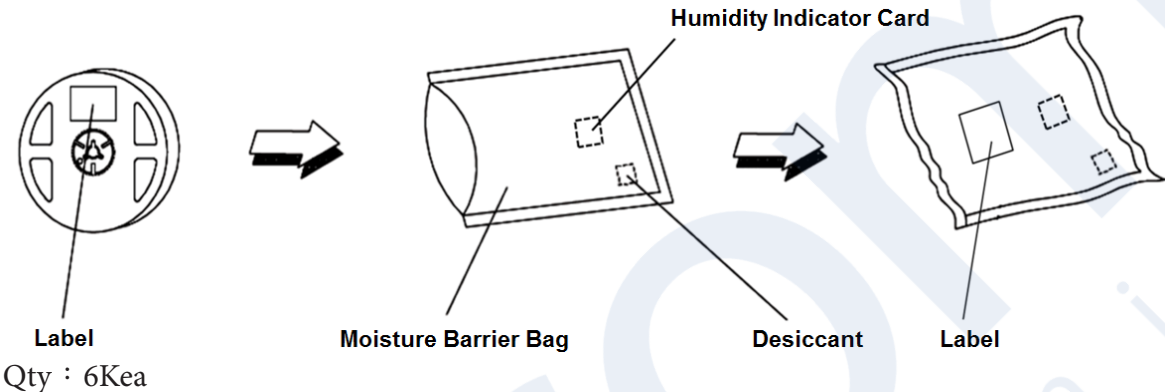

Note for Figure 15:  
1. Drawings are not to scale.

# Design Resources

## Optical Source Models

Please contact your Bridgelux sales representative for assistance.

## Precautions

### CAUTION: CHEMICAL EXPOSURE HAZARD

Exposure to some chemicals commonly used in luminaire manufacturing and assembly can cause damage to the CSP.

### CAUTION: EYE SAFETY

Eye safety classification for the use of Bridgelux CSP is in accordance with IEC specification 62471: Photobiological Safety of Lamps and Lamp Systems. Most of Bridgelux CSPs are classified as Risk Group Exempt or Risk Group 1 in accordance with IEC specification 62471. However, the CSP LEDs will be classified as Risk Group 2 when operated at high power conditions with high ratio blue wavelength in the emission spectrum depending on characteristics. Please use appropriate precautions. It is important that employees working with LEDs are trained to use them safely.

### CAUTION: RISK OF BURN

Do not touch the CSP LES during operation. Allow the CSP to cool for a sufficient period of time before handling. The CSP may reach elevated temperatures such that could burn skin when touched.

### CAUTION: PICK AND PLACE

Recommend using Teflon material for nozzle. Sharp steel material must not be used as pick up tools.

## CAUTION

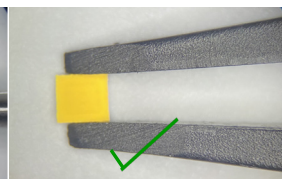
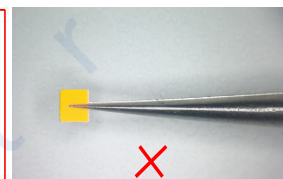
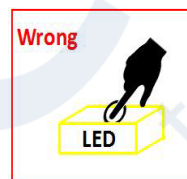

## Disclaimers

### MINOR PRODUCT CHANGE POLICY

The rigorous qualification testing on products offered by Bridgelux provides performance assurance. Slight cosmetic changes that do not affect form, fit, or function may occur as Bridgelux continues product optimization.

### STANDARD TEST CONDITIONS

Unless otherwise stated, LED emitter testing is performed at the nominal drive current.