

Bridgetek Pte Ltd

VM820C BT820 Credit Card Module Datasheet

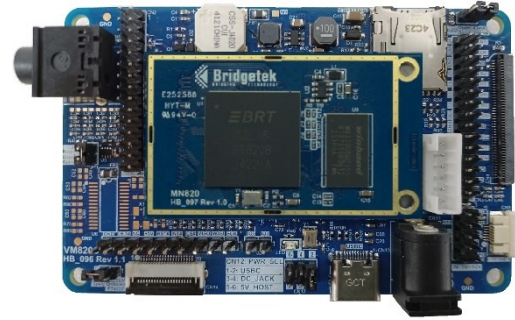

1 Introduction

The VM820C BT820 Credit Card Module functions as the baseboard for development modules designed specifically for Bridgetek's latest embedded video engine, the EVE5 BT820.

Paired with the MN820 System on Module (SoM), it demonstrates the BT820's capabilities, supporting developers in assessing the IC's performance and functionality.

Equipped with power and audio circuits, a bridge IC, and IO connectors, the baseboard enables smooth communication with external devices.

It supports multiple power input sources ranging from 5V to 12V, making it well-suited for driving large LCD panels. Power can be provided via an MCU host, USB host/charger, or a DC adapter.

Additionally, the FTDI FT4222H bridge IC integration enables the development board to operate as a USB slave, allowing it to be controlled by a USB host.

1.1 Features

- MN820 BT820 mini module included
- Dual channel LVDS transmit interface
- Supports LCD resolutions up to 1920 x 1200 with capacitive touch
- Integrated LED Driver for LCD backlight.
- Dual channel LVDS receiver interface
- Supports video input up to 1920x1200 pixels
- 1Gbit onboard NAND Flash Memory
- Micro-SD card socket for additional storage
- Stereo audio output support
- Audio buzzer for alerts and notifications
- FPC connectors for LCD and capacitive touch panels
- High speed USB connectivity for PC or USB host
- SPI/QSPI host interface via 12 pin header or 20-pin FPC connector
- Flexible power options, powered through SPI host connector, USB C or DC power jack

Neither the whole nor any part of the information contained in, or the product described in this manual, may be adapted or reproduced in any material or electronic form without the prior written consent of the copyright holder. This product and its documentation are supplied on an as-is basis and no warranty as to their suitability for any particular purpose is either made or implied. Bridgetek Pte Ltd will not accept any claim for damages howsoever arising as a result of use or failure of this product. Your statutory rights are not affected. This product or any variant of it is not intended for use in any medical appliance, device or system in which the failure of the product might reasonably be expected to result in personal injury. This document provides preliminary information that may be subject to change without notice. No freedom to use patents or other intellectual property rights is implied by the publication of this document. Bridgetek Pte Ltd, 1 Tai Seng Avenue, #03-05, Singapore 4536464. Singapore Registered Company Number: 201542387H

2 Ordering Information

Part No.	Description
VM820C	BT820 Credit Card Module, including MN820

Table 1 - Ordering Information

Table of Contents

1	Introduction	1
1.1	Features	1
2	Ordering Information	2
3	Hardware Description	5
3.1	VM820C Baseboard	5
3.2	Physical Descriptions	7
4	Board Schematics	17
5	Hardware Configuration	21
5.1	Power Configuration	21
5.2	Backlight LED Current Configuration	21
6	VM820C Hardware Setup	24
6.1	Communication Interface.....	24
6.2	Selecting Power Source.....	25
6.3	LVDS Transmit Interface	25
6.4	Audio Interface	26
6.5	Memory Interface.....	26
7	Electrical Specifications	27
8	Mechanical Dimensions	28
8.1	VM820C PCB Dimensions.....	28
9	Software Setup Information	29
9.1	Running EveApps-BT82X	29
9.2	Configuring the Communication Interface.....	29
9.3	Running Sample Codes	30
9.4	Example of VM820C running EVEApps-BT82X with 10.1" 1920 x 1200 LCD Panel	31
10	Disclaimer Notice: Use of Third-Party Software or Websites	33

11 Contact Information.....	34
Appendix A – References.....	35
Document References	35
Acronyms and Abbreviations	35
Appendix B – List of Tables & Figures.....	37
List of Tables	37
List of Figures	37
Appendix C – Revision History.....	39

3 Hardware Description

3.1 VM820C Baseboard

The VM820C baseboard module is a four-layer PCB featuring single-sided component placement, designed in a credit card-sized form factor. The final PCBA are 89 mm x 54 mm x 11 mm.

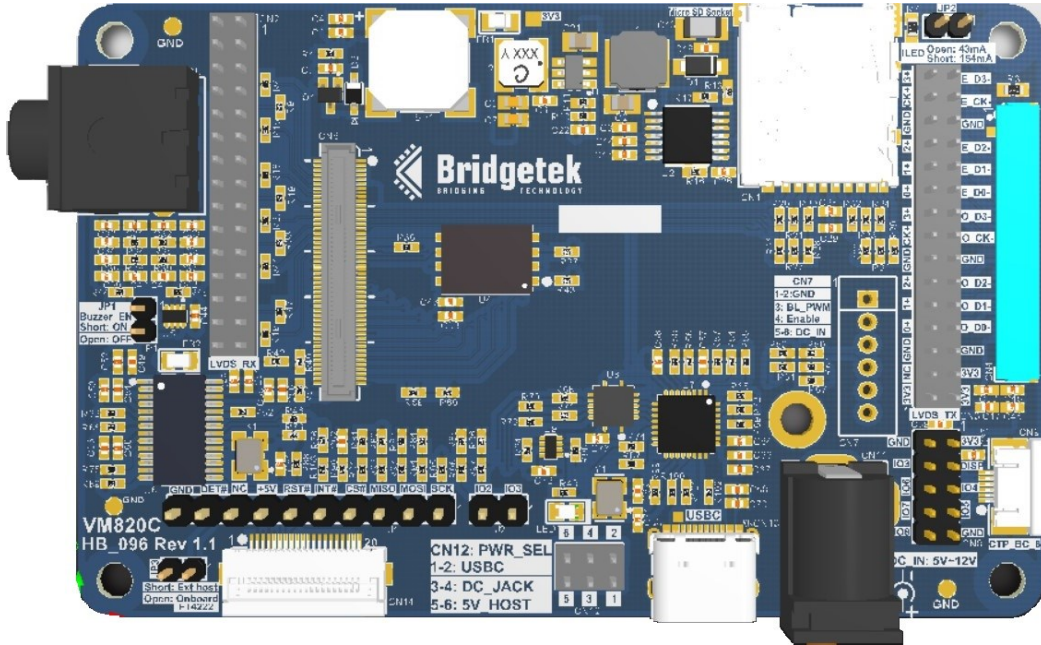

Figure 1 – VM820C Base Board PCBA – Front View

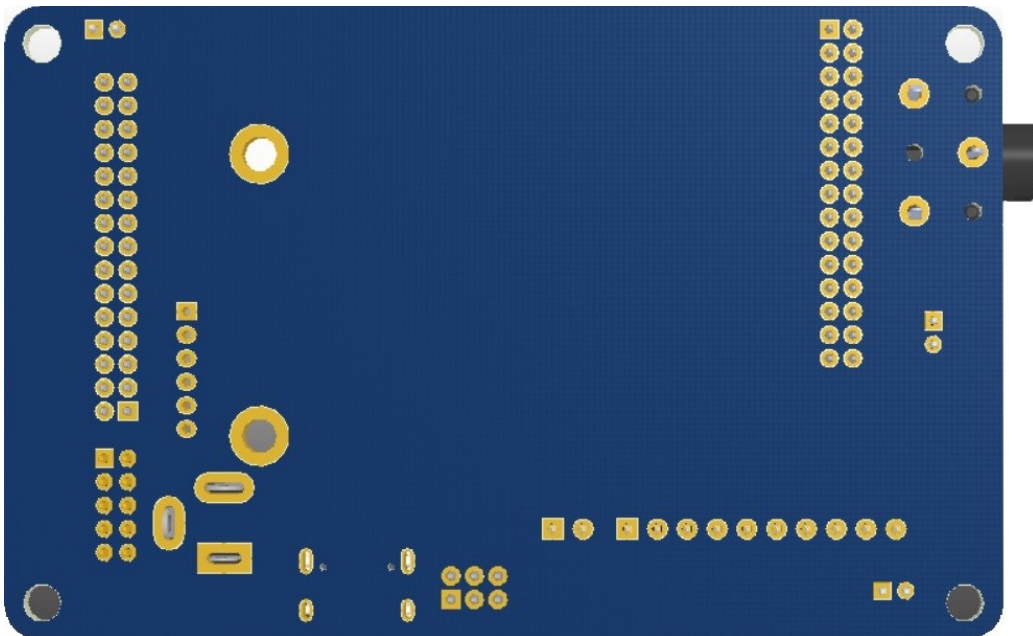

Figure 2 – VM820C Base Board PCBA – Back View

3.1.1 Major Features

- **High-speed connection:** 100-position board-to-board receptacle for interfacing with the MN820 SoM.
- **Memory:** Integrated 1Gbit NAND Flash memory.
- **Storage:** Micro-SD card slot for additional storage needs.
- **Power supply options:** Accepts input power supply of range 5V~12V via 2.1mm DC power jack or 5V supply via USB C, 12-pin header or 20-pins FPC connector
- **Power regulation:** DC-DC converter steps down input power to 3.3V for system requirements.
- **LCD backlight driver:** Supports up to 3A current at 40V.
- **LVDS transmission:** Dual-channel LVDS transmission interface through a 30-position 2mm header.
- **LVDS input:** Dual-channel LVDS input supported via a 30-position 2mm header.
- **Display support:** Supports LVDS LCD panels through a 45-position FPC connector.
- **Touch support:** Supports I2C capacitive touch panels via a 6-position FPC connector.
- **USB connectivity:** High-speed USB connection to PC or USB host using the onboard FTDI FT4222H bridge IC.
- **Host MCU interface:** SPI/QSPI host MCU connection available via a 12-pin header or 20-pin FPC connector.
- **Audio output:** Stereo line-out via a tri-stage audio filter connected to an audio socket for external speakers.
- **Alerts:** Built-in buzzer for notifications and alerts.
- **GPIO support:** Seven GPIO control pins accessible through a 10-position 2mm header.

Refer to the [MN820 Mini Module datasheet](#) for detailed hardware specifications of the MN820.

3.2 Physical Descriptions

3.2.1 PCB layout

The VM820C is a four-layer printed circuit board measuring 85mm x 54mm x 1.6mm, featuring single-sided component placement. It is designed with 100-ohm impedance trace control for both LVDS transmission and reception traces.

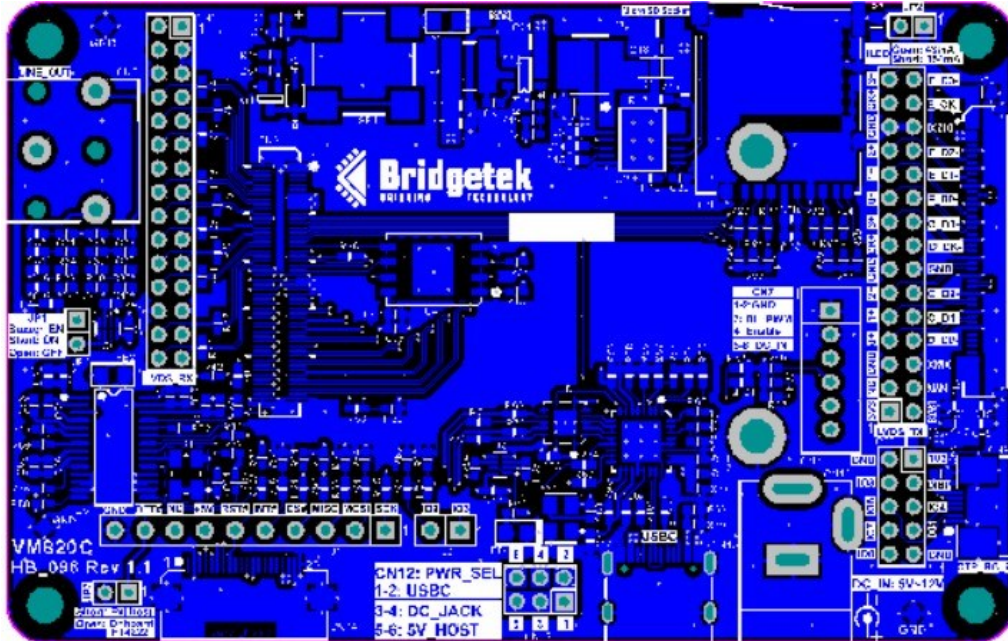

Figure 3 – VM820C PCB Top Layer

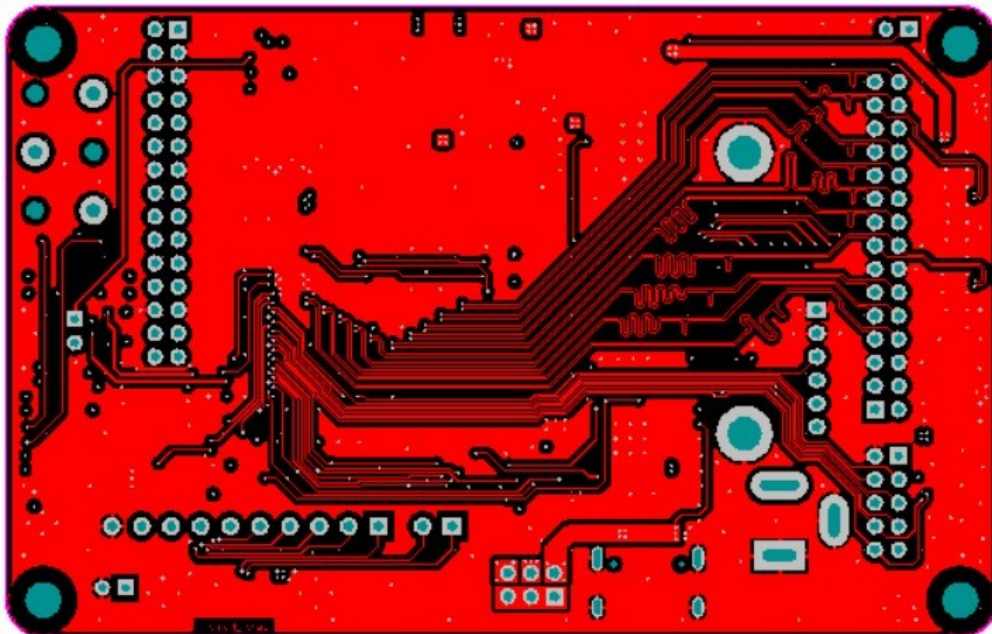

Figure 4 – VM820C PCB Bottom Layer

3.2.2 Connectors and Jumpers

Connectors and jumpers are described in the following sections.

- **CN1 – Micro SD Card Connector**

The onboard Micro SD card socket supports single SPI communication mode and auto card detection.

- **CN2 – Dual Channel LVDS Receiver Interface**

This 30-position 2mm header supports dual-channel LVDS receive signals, adhering to the standard industrial pin definition as detailed in Table 2 – CN2 Pinout below.

Pin No.	Name	Type	Description
1	NC	NA	No connection
2	NC	NA	No connection
3	NC	NA	No connection
4	GND	P	Ground
5	GND	P	Ground
6	GND	P	Ground
7	LVDS_RX0_D0_P	I	LVDS RX odd channel data bit 0 differential P
8	LVDS_RX0_D0_N	I	LVDS RX odd channel data bit 0 differential N
9	LVDS_RX0_D1_P	I	LVDS RX odd channel data bit 1 differential P
10	LVDS_RX0_D1_N	I	LVDS RX odd channel data bit 1 differential N
11	LVDS_RX0_D2_P	I	LVDS RX odd channel data bit 2 differential P
12	LVDS_RX0_D2_N	I	LVDS RX odd channel data bit 2 differential N
13	GND	I	Ground
14	GND	I	Ground
15	LVDS_RX0_CLK_P	I	LVDS RX odd channel clock differential P signal
16	LVDS_RX0_CLK_N	I	LVDS RX odd channel clock differential N signal
17	LVDS_RX0_D3_P	I	LVDS RX odd channel data bit 3 differential P
18	LVDS_RX0_D3_N	I	LVDS RX odd channel data bit 3 differential N
19	LVDS_RX1_D0_P	I	LVDS RX even channel data bit 0 differential P
20	LVDS_RX1_D0_N	I	LVDS RX even channel data bit 0 differential N
21	LVDS_RX1_D1_P	I	LVDS RX even channel data bit 1 differential P
22	LVDS_RX1_D1_N	I	LVDS RX even channel data bit 1 differential N
23	LVDS_RX1_D2_P	I	LVDS RX even channel data bit 2 differential P
24	LVDS_RX1_D2_N	I	LVDS RX even channel data bit 2 differential N
25	GND	I	Ground
26	GND	I	Ground
27	LVDS_RX1_CLK_P	I	LVDS RX even channel clock differential P signal
28	LVDS_RX1_CLK_N	I	LVDS RX even channel clock differential N signal
29	LVDS_RX1_D3_P	I	LVDS RX even channel data bit 3 differential P
30	LVDS_RX1_D3_N	I	LVDS RX even channel data bit 3 differential N

Table 2 – CN2 Pinout

• **CN3 – Dual Channel LVDS Transmitter Interface**

This 30 position 2mm header supports dual channel LVDS transmit signals, following the standard industrial pin definition defined in Table 3 – CN3 Pinout below.

Pin No.	Name	Type	Description
1	VCC3V3	P	3.3V output power supply
2	VCC3V3	P	3.3V output power supply
3	NC	NA	No connection
4	VCC3V3	P	3.3V output power supply
5	GND	P	Ground
6	GND	P	Ground
7	LVDS_TX0_D0_P	O	LVDS TX odd channel data bit 0 differential P
8	LVDS_TX0_D0_N	O	LVDS TX odd channel data bit 0 differential N
9	LVDS_TX0_D1_P	O	LVDS TX odd channel data bit 1 differential P
10	LVDS_TX0_D1_N	O	LVDS TX odd channel data bit 1 differential N
11	LVDS_TX0_D2_P	O	LVDS TX odd channel data bit 2 differential P
12	LVDS_TX0_D2_N	O	LVDS TX odd channel data bit 2 differential N
13	GND	O	Ground
14	GND	O	Ground
15	LVDS_TX0_CLK_P	O	LVDS TX odd channel clock differential P signal
16	LVDS_TX0_CLK_N	O	LVDS TX odd channel clock differential N signal
17	LVDS_TX0_D3_P	O	LVDS TX odd channel data bit 3 differential P
18	LVDS_TX0_D3_N	O	LVDS TX odd channel data bit 3 differential N
19	LVDS_TX1_D0_P	O	LVDS TX even channel data bit 0 differential P
20	LVDS_TX1_D0_N	O	LVDS TX even channel data bit 0 differential N
21	LVDS_TX1_D1_P	O	LVDS TX even channel data bit 1 differential P
22	LVDS_TX1_D1_N	O	LVDS TX even channel data bit 1 differential N
23	LVDS_TX1_D2_P	O	LVDS TX even channel data bit 2 differential P
24	LVDS_TX1_D2_N	O	LVDS TX even channel data bit 2 differential N
25	GND	O	Ground
26	GND	O	Ground
27	LVDS_TX1_CLK_P	O	LVDS TX even channel clock differential P signal
28	LVDS_TX1_CLK_N	O	LVDS TX even channel clock differential N signal
29	LVDS_TX1_D3_P	O	LVDS TX even channel data bit 3 differential P
30	LVDS_TX1_D3_N	O	LVDS TX even channel data bit 3 differential N

Table 3 – CN3 Pinout

• **CN4 –LVDS LCD Panel Interface**

This 45-position, 0.5mm pitch top and bottom contact FPC connector from Hirose supports LCD panels with an LVDS interface. The manufacturer's part number for the connector is "FH34SRJ-45S-0.5SH (50)."

Pin No.	Name	Type	Description
1	LEDK	P	LED Cathode
2	LEDK	P	LED Cathode
3	LEDA	P	LED Anode
4	LEDA	P	LED Anode
5	NC	NA	No Connection
6	GND	P	Ground
7	LVDS_TX1_D3_P	O	LVDS TX even channel data bit 3 differential P
8	LVDS_TX1_D3_N	O	LVDS TX even channel data bit 3 differential N
9	GND	P	Ground
10	LVDS_TX1_D2_P	O	LVDS TX even channel data bit 2 differential P
11	LVDS_TX1_D2_N	O	LVDS TX even channel data bit 2 differential N
12	GND	P	Ground
13	LVDS_TX1_CLK_P	O	LVDS TX even channel clock differential P signal
14	LVDS_TX1_CLK_N	O	LVDS TX even channel clock differential N signal
15	GND	P	Ground
16	LVDS_TX1_D1_P	O	LVDS TX even channel data bit 1 differential P
17	LVDS_TX1_D1_N	O	LVDS TX even channel data bit 1 differential N
18	GND	P	Ground
19	LVDS_TX1_D0_P	O	LVDS TX even channel data bit 0 differential P
20	LVDS_TX1_D0_N	O	LVDS TX even channel data bit 0 differential N
21	GND	P	Ground
22	LVDS_TX0_D3_P	O	LVDS TX odd channel data bit 3 differential P
23	LVDS_TX0_D3_N	O	LVDS TX odd channel data bit 3 differential N
24	GND	P	Ground
25	LVDS_TX0_D2_P	O	LVDS TX odd channel data bit 2 differential P
26	LVDS_TX0_D2_N	O	LVDS TX odd channel data bit 2 differential N
27	GND	P	Ground
28	LVDS_TX0_CLK_P	O	LVDS TX odd channel clock differential P signal
29	LVDS_TX0_CLK_N	O	LVDS TX odd channel clock differential N signal
30	GND	P	Ground
31	LVDS_TX0_D1_P	O	LVDS TX odd channel data bit 1 differential P
32	LVDS_TX0_D1_N	O	LVDS TX odd channel data bit 1 differential N
33	GND	P	Ground
34	LVDS_TX0_D0_P	O	LVDS TX odd channel data bit 0 differential P
35	LVDS_TX0_D0_N	O	LVDS TX odd channel data bit 0 differential N
36	GND	P	Ground
37	NC	NA	No Connection
38	NC	NA	No Connection
39	NC	NA	No Connection

40	NC	NA	No Connection
41	VCC3V3	P	3.3V output power supply
42	VCC3V3	P	3.3V output power supply
43	VCC3V3	P	3.3V output power supply
44	VCC3V3	P	3.3V output power supply
45	VCC3V3	P	3.3V output power supply

Table 4 – CN4 Pinout

- **CN5 – Audio Connector**

The BT820 stereo sigma-delta PWM signals are processed through a tri-stage low-pass filter and output through this audio socket, enabling connection to active speakers.

- **CN6 – Baseboard to SoM Interconnector**

This 100-position, 0.4mm pitch board-to-board connector serves as the interface between the VM820C baseboard and the MN820 SoM module. The USB4 Gen.2 connector, model "DF40C-100DS-0.4V (51)" from Hirose, supports data transmission speeds of up to 20 Gbps.

Pin No.	Name	Type	Description
1	GND	P	Ground
2	GND	P	Ground
3	GND	P	Ground
4	LVDS_RX0_D0_N	I	LVDS RX odd channel data bit 0 differential N
5	NC	NA	No Connection
6	LVDS_RX0_D0_P	I	LVDS RX odd channel data bit 0 differential P
7	NC	NA	No Connection
8	LVDS_RX0_D1_N	I	LVDS RX odd channel data bit 1 differential N
9	NC	NA	No Connection
10	LVDS_RX0_D1_P	I	LVDS RX odd channel data bit 1 differential P
11	NC	NA	No Connection
12	LVDS_RX0_D2_N	I	LVDS RX odd channel data bit 2 differential N
13	VCC3V3	P	3.3V output power supply
14	LVDS_RX0_D2_P	I	LVDS RX odd channel data bit 2 differential P
15	VCC3V3	P	3.3V output power supply
16	LVDS_RX0_CLK_N	I	LVDS RX odd channel clock differential N signal
17	VCC3V3	P	3.3V output power supply
18	LVDS_RX0_CLK_P	I	LVDS RX odd channel clock differential P signal
19	VCC3V3	P	3.3V output power supply
20	LVDS_RX0_D3_N	I	LVDS RX odd channel data bit 3 differential N
21	SD_CD	I	SD Card: Card Detect
22	LVDS_RX0_D3_P	I	LVDS RX odd channel data bit 3 differential P
23	SD_D0	I/O	SD Card: Data bus line 0
24	GND	P	Ground
25	SD_D1	I/O	SD Card: Data bus line 1
26	LVDS_RX1_D0_N	I	LVDS RX even channel data bit 0 differential N
27	SD_D2	I/O	SD Card: Data bus line 2
28	LVDS_RX1_D0_P	I	LVDS RX even channel data bit 0 differential P

29	SD_D3	I/O	SD Card: Data bus line 3
30	LVDS_RX1_D1_N	I	LVDS RX even channel data bit 1 differential N
31	SD_CLK	O	SD Card: Serial clock output
32	LVDS_RX1_D1_P	I	LVDS RX even channel data bit 1 differential P
33	SD_CMD	I/O	SD Card: Command signal
34	LVDS_RX1_D2_N	I	LVDS RX even channel data bit 2 differential N
35	SPIM_MOSI	I/O	SPI flash MOSI line
36	LVDS_RX1_D2_P	I	LVDS RX even channel data bit 2 differential P
37	SPIM_MISO	I/O	SPI flash MISO line
38	LVDS_RX1_CLK_N	I	LVDS RX even channel clock differential N signal
39	SPIM_IO3	I/O	SPI flash IO3 line
40	LVDS_RX1_CLK_P	I	LVDS RX even channel clock differential P signal
41	SPIM_IO2	I/O	SPI flash IO2 line
42	LVDS_RX1_D3_N	I	LVDS RX even channel data bit 3 differential N
43	SPIM_SS_N	O	SPI flash chips select output line
44	LVDS_RX1_D3_P	I	LVDS RX even channel data bit 3 differential P
45	SPIM_SCLK	O	SPI flash clock output line
46	GND	P	Ground
47	GND	P	Ground
48	AUDIO_R	O	Audio Sigma-delta right output
49	GND	P	Ground
50	GND	P	Ground
51	GND	P	Ground
52	AUDIO_L	O	Audio Sigma-delta left output
53	GND	P	Ground
54	GND	P	Ground
55	GND	P	Ground
56	I2S_LRCLK	I	I2S left/right clock indicator
57	LVDS_TX0_D0_N	O	LVDS TX odd channel data bit 0 differential N
58	I2S_BCLK	I	I2S bit clock
59	LVDS_TX0_D0_P	O	LVDS TX odd channel data bit 0 differential P
60	I2S_SDA	O	I2S serial data output
61	LVDS_TX0_D1_N	O	LVDS TX odd channel data bit 1 differential N
62	DISP	O	LCD Display general purpose control signal
63	LVDS_TX0_D1_P	O	LVDS TX odd channel data bit 1 differential P
64	BKLIT_PWM	O	LED backlight brightness PWM control signal
65	LVDS_TX0_D2_N	O	LVDS TX odd channel data bit 2 differential N
66	GND	P	Ground
67	LVDS_TX0_D2_P	O	LVDS TX odd channel data bit 2 differential P
68	GPIO3	I/O	General purpose IO 3
69	LVDS_TX0_CLK_N	O	LVDS TX odd channel clock differential N signal
70	GPIO2	I/O	General purpose IO 2
71	LVDS_TX0_CLK_P	O	LVDS TX odd channel clock differential P signal
72	GPIO4	I/O	General purpose IO 4
73	LVDS_TX0_D3_N	O	LVDS TX odd channel data bit 3 differential N
74	GPIO6	I/O	General purpose IO 6

75	LVDS_TX0_D3_P	O	LVDS TX odd channel data bit 3 differential P
76	GPI05	I/O	General purpose IO 5
77	GND	P	Ground
78	GPI07	I/O	General purpose IO 7
79	LVDS_TX1_D0_N	O	LVDS TX even channel data bit 0 differential N
80	GPI08	I/O	General purpose IO 8
81	LVDS_TX1_D0_P	O	LVDS TX even channel data bit 0 differential P
82	GND	P	Ground
83	LVDS_TX1_D1_N	O	LVDS TX even channel data bit 1 differential N
84	SPIS_MISO	I/O	SPI data line 1
85	LVDS_TX1_D1_P	O	LVDS TX even channel data bit 1 differential P
86	SPIS_SCLK	I	SPI clock input
87	LVDS_TX1_D2_N	O	LVDS TX even channel data bit 2 differential N
88	SPIS_SS_N	I	SPI slave select input
89	LVDS_TX1_D2_P	O	LVDS TX even channel data bit 2 differential P
90	SPIS_MOSI	I/O	SPI data line 0
91	LVDS_TX1_CLK_N	O	LVDS TX even channel clock differential N signal
92	SPIS_IO3	I/O	SPI data line 3
93	LVDS_TX1_CLK_P	O	LVDS TX even channel clock differential P signal
94	SPIS_IO2	I/O	SPI data line 2
95	LVDS_TX1_D3_N	O	LVDS TX even channel data bit 3 differential N
96	INT_N	OD/O	Interrupt to host, active low
97	LVDS_TX1_D3_P	O	LVDS TX even channel data bit 3 differential P
98	RESET_N	I	Global reset pin.
99	GND	P	Ground
100	GND	P	Ground

Table 5 – CN6 Pinout

- **CN7 – Output Power for LED Drivers**

This 6 position 2mm pitch power connector can be used to provide power to external LED drivers.

Pin No.	Name	Type	Description
1	GND	P	Ground
2	GND	P	Ground
3	BKLIT_PWM	O	LED backlight brightness PWM control signal
4	-	O	Pin pulled high to VCC3V3 via 10K resistor
5	DC_IN	P	Output power source from DC power adaptor
6	DC_IN	P	Output power source from DC power adaptor

Table 6 – CN7 Pinout

- **CN8 – GPIO Interface**

This 10-position GPIO header provides DISP control signals and seven GPIO pins for connecting to external devices. GPIO 5 to GPIO 8 also feature an I2C interface for interfacing with external capacitive touch panels.

Pin No.	Name	Type	Description
1	VCC3V3	P	3.3V output power supply
2	GND	P	Ground
3	DISP	O	LCD Display general purpose control signal
4	GPIO3	I/O	General purpose IO 3
5	GPIO4	I/O	General purpose IO 4
6	GPIO6	I/O	General purpose IO 6
7	GPIO5	I/O	General purpose IO 5
8	GPIO7	I/O	General purpose IO 7
9	GND	P	Ground
10	GPIO8	I/O	General purpose IO 8

Table 7 – CN8 Pinout

- **CN9 –Capacitive Touch Panel Interface**

This 6-position 0.5mm pitch bottom contact FPC connector provides support to LCD panels with capacitive touch function.

Pin No.	Name	Type	Description
1	GND	P	Ground
2	GPIO6	I/O	SDA
3	GPIO5	I/O	SCL
4	GPIO7	I	Interrupt input from CTP
5	GPIO8	O	Reset output to CTP
6	VCC3V3	P	3.3V Output power supply

Table 8 – CN9 Pinout

- **CN11 – Input Power Source**

This 2.1mm DC power jack accepts a 5V to 12V power input to the board, making it essential for powering large LCD panels.

- **CN12 – Input Power Selection Header**

This input power selection header directs the chosen input power to the system power, providing power to the onboard circuits.

Pin No.	Name	Type	Description
1	VSYS	P	System power supply for onboard circuits
2	USB_5V	P	5V Input power source from USB C connector
3	VSYS	P	System power supply for onboard circuits
4	DC_IN	P	5V~12V Input power source from DC power jack
5	VSYS	P	System power supply for onboard circuits

6	HOST_5V	P	5V Input power source from MCU host
---	---------	---	-------------------------------------

Table 9 – CN12 Pinout

- **CN13 – USB-C Receptacle**

The USB-C receptacle supplies power to the board and enables PC communication with EVE via SPI/QSPI through the FT4222H bridge circuit.

- **CN14 – SPI/QSPI Interface**

This 20-position, 0.5mm pitch FPC connector, part number "ZIF0520DH-CF25" from Riverdi, enables developers to provide power to the board and communicate with EVE through an SPI/QSPI interface via a host MCU.

Pin No.	Name	Type	Description
1	NC	NA	No Connection
2	GND	P	Ground
3	HOST_SCLK	I	SPI Clock input
4	HOST_MISO	I/O	SPI Single mode: SPI MISO output SPI Dual/Quad mode: SPI data line 1
5	HOST_MOSI	I/O	SPI Single mode: SPI MOSI input SPI Dual/Quad mode: SPI data line 0
6	HOST_SS_N	I	SPI slave select input, active low
7	HOST_INTN	OD	Host interrupt open drain output, active low.
8	HOST_RSTN	I	EVE reset, active low.
9	NC	NA	No Connection
10	NC	NA	No Connection
11	HOST_IO2	I/O	SPI Single mode: General purpose IO 0 SPI Quad mode: SPI data line 2
12	HOST_IO3	I/O	SPI Single mode: General purpose IO 1 SPI Quad mode: SPI data line 3
13	NC	NA	No Connection
14	NC	NA	No Connection
15	NC	NA	No Connection
16	NC	NA	No Connection
17	HOST_5V	P	5V Input power source
18	HOST_5V	P	5V Input power source
19	GND	P	Ground
20	GND	P	Ground

Table 10 – CN14 Pinout

- **J1 – SPI Interface**

This 10-position header enables developers to power the board and establish communication with EVE via an SPI interface through a host MCU.

Pin No.	Name	Type	Description
1	HOST_SCLK	I	SPI Clock input
2	HOST_MOSI	I/O	SPI Single mode: SPI MOSI input SPI Dual/Quad mode: SPI data line 0
3	HOST_MISO	I/O	SPI Single mode: SPI MISO output SPI Dual/Quad mode: SPI data line 1

4	HOST_SS_N	I	SPI slave select input, active low
5	HOST_INTN	OD	Host interrupt open drain output, active low.
6	HOST_RSTN	I	EVE reset, active low.
7	HOST_5V	P	5V Input power source
8	NC	NA	No Connection
9	HOST_DET#	I	Host presence detection pin. Connect to GND to disable on-board FT4222H.
10	GND	P	Ground

Table 11 – J1 Pinout

- J2 – QSPI Interface**

This 2-position 2.54mm pitch header is connected to the IO2 and IO3 pins of the QSPI interface to EVE. When used with J1, it enables QSPI communication.

Pin No.	Name	Type	Description
1	HOST_IO3	I/O	SPI Single mode: General purpose IO 1 SPI Quad mode: SPI data line 3
2	HOST_IO2	I/O	SPI Single mode: General purpose IO 0 SPI Quad mode: SPI data line 2

Table 12 – J2 Pinout

- JP1 – Buzzer Enable Select**

This jumper header routes the left-channel audio to the buzzer input when shorted.

JP1	Buzzer
Open	OFF
Short (Default)	ON

Table 13 – JP1 Pin Options

- JP2 – ILED Current Select**

This jumper is used to select the ILED current from the backlight driver that powers the LCD.

JP2	ILED (mA)
Open (Default)	42.5
Short	154

Table 14 – JP2 Pin Options

- JP3 – SPI Host Selection**

This jumper allows selection between the onboard FT4222H bridge IC and the external host MCU, determining which device controls the SPI/QSPI bus for communication with EVE.

JP3	SPIS Control
Open (Default)	Onboard FT4222H
Short	External Host

Table 15 – JP3 Pin Options

4 Board Schematics

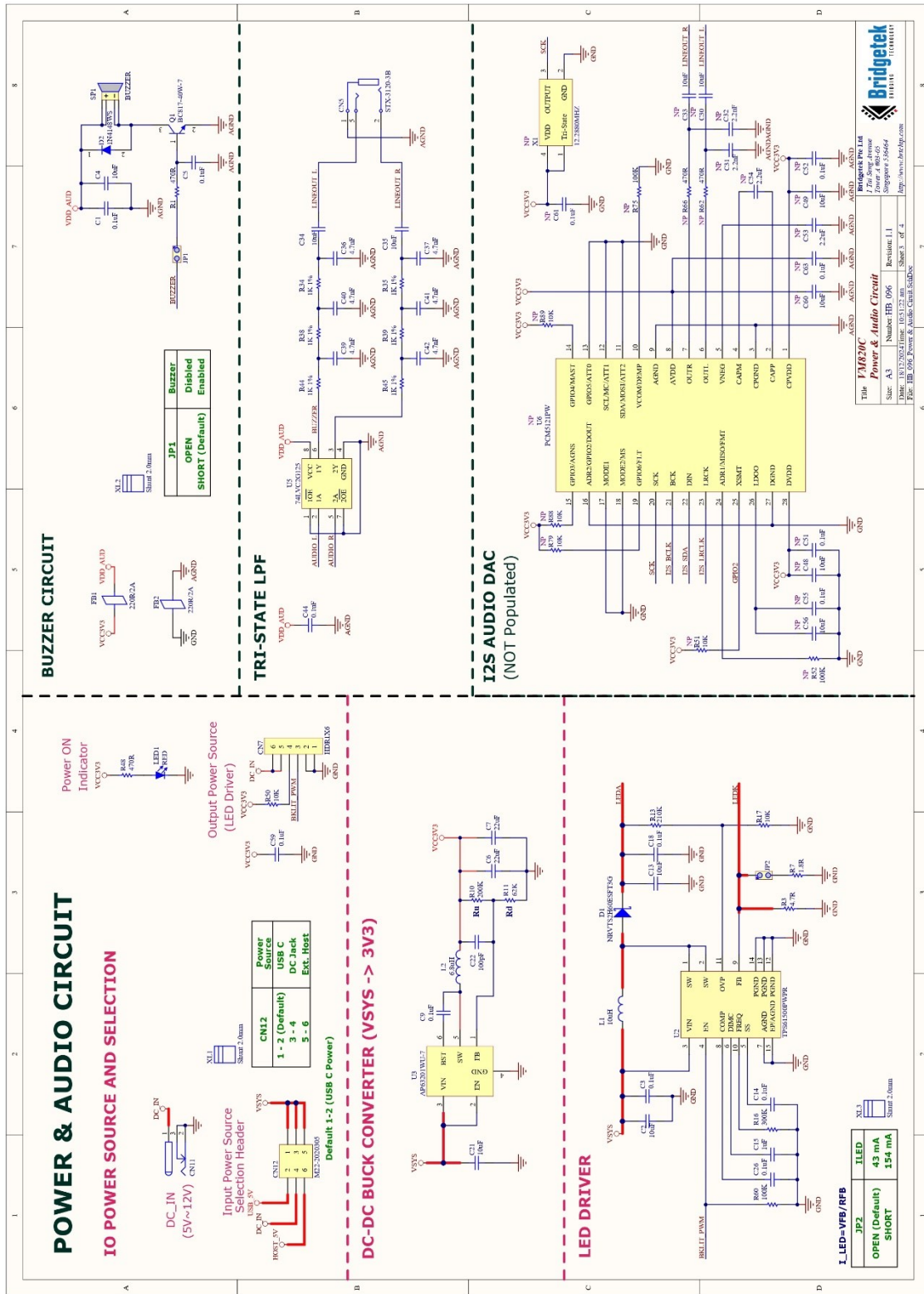

Figure 5 - Power and Audio Circuit

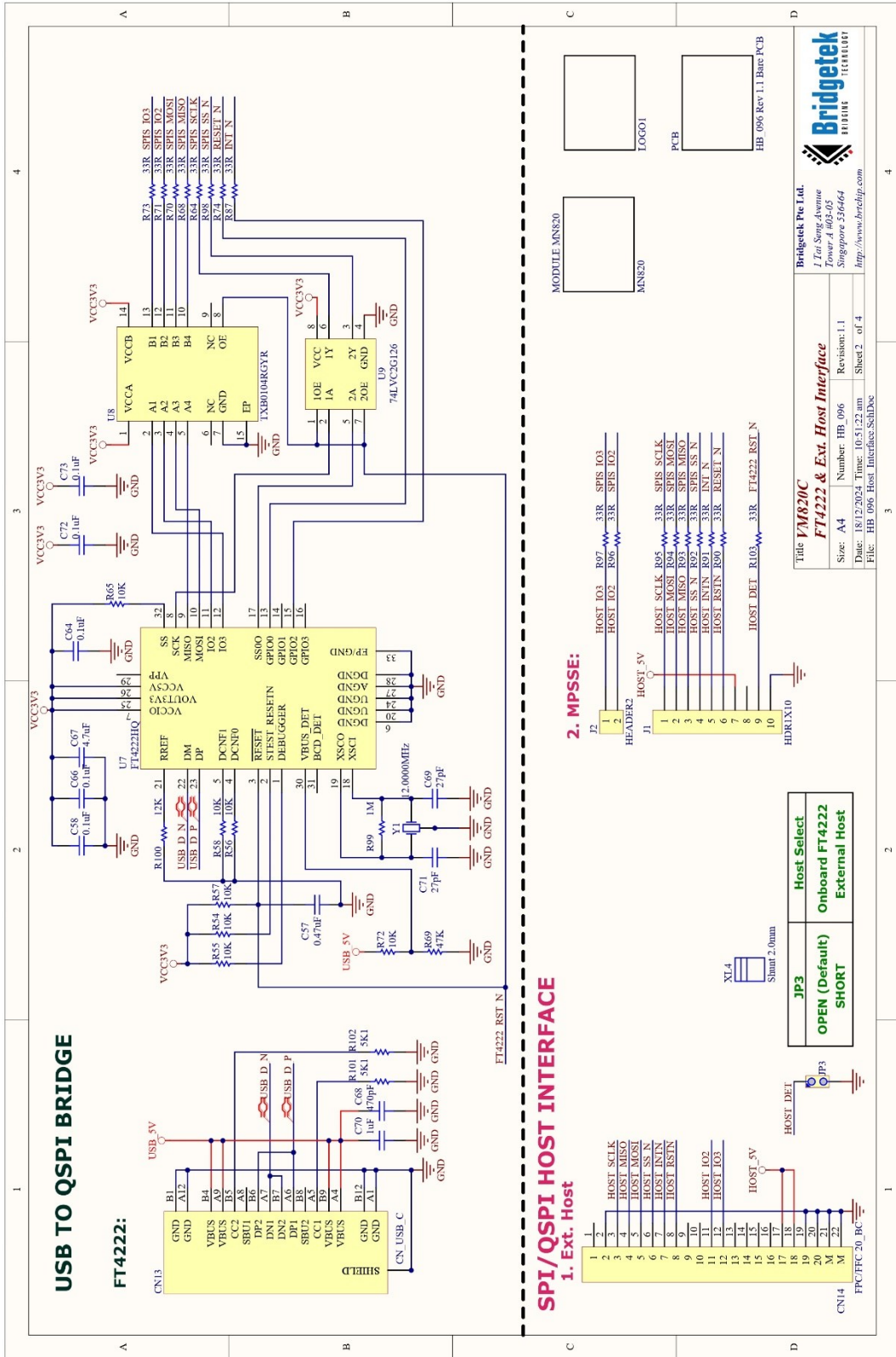
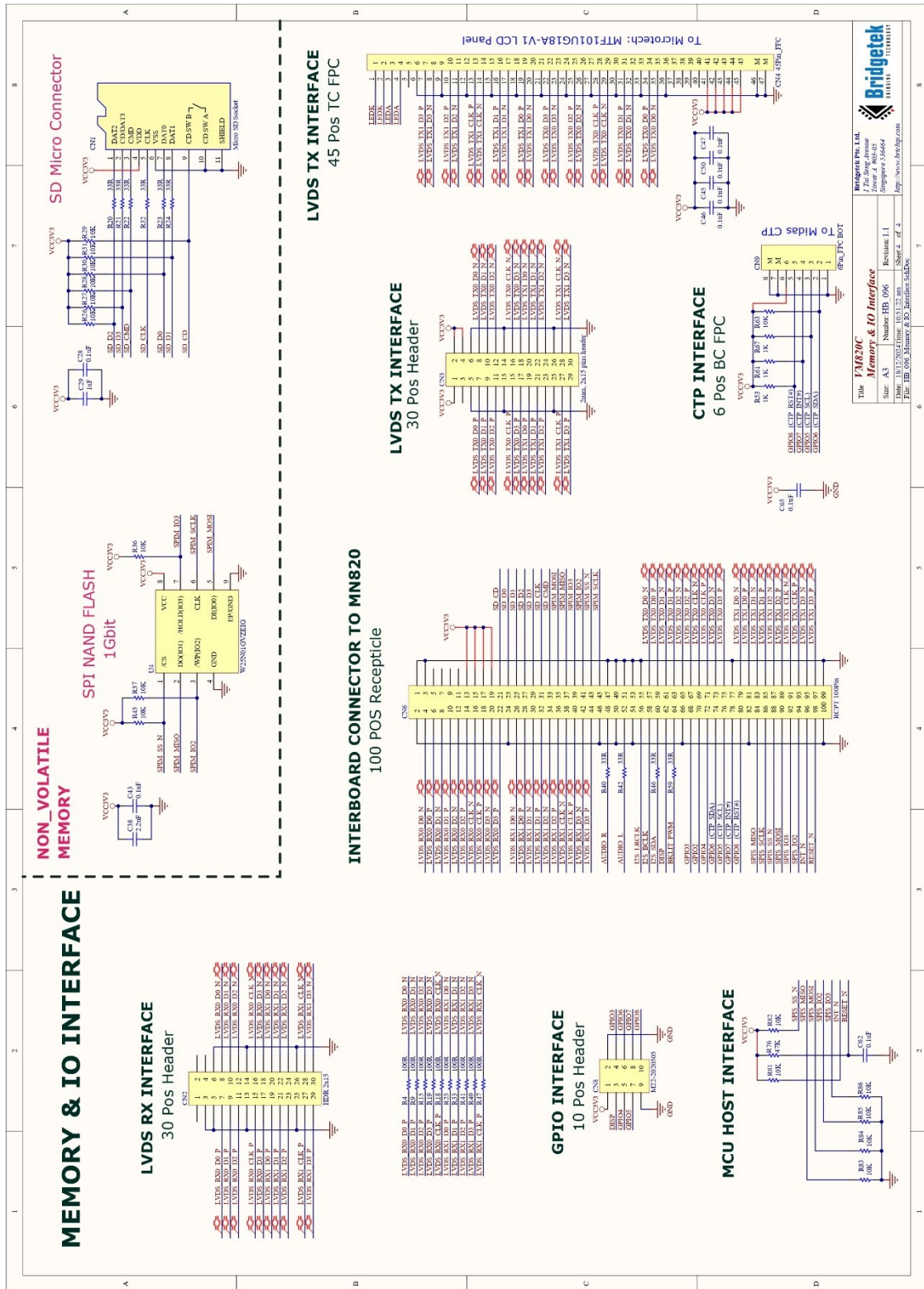

Figure 6 – Host Interface



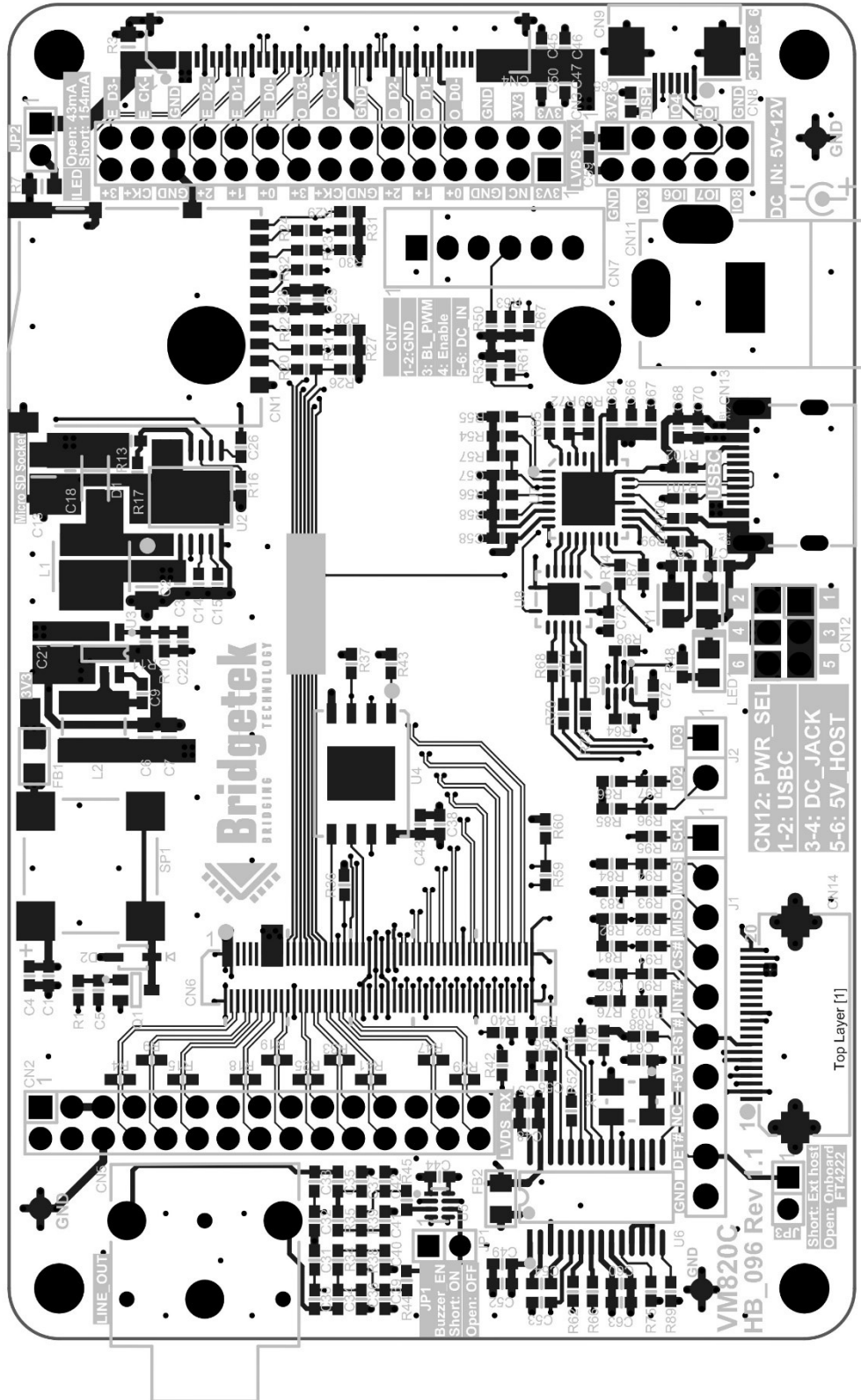

Figure 8 – Assembly Drawing

5 Hardware Configuration

5.1 Power Configuration

The VM820C base board can be powered using one of three options:

- **5V USB Power:** Connect a cable to the USB-C receptacle (CN13).
- **5V~12V DC IN:** Supply power via DC jack (CN11).
- **5V Host Power:** Provide power alongside the host MCU connection through header (J1) or the FPC connector (CN14).

Refer to Figure 9 and Table 16 below for instructions on powering the VM820C board.

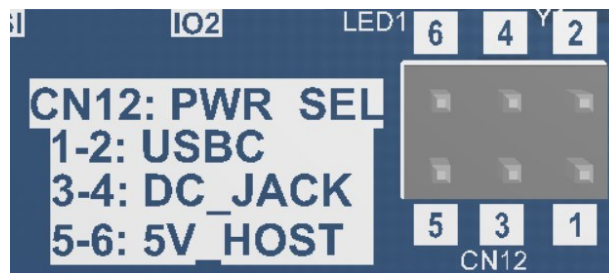

Figure 9 - Power Source Selection Header

Short Pins	Selected Power Source
1 - 2	USB C
3 - 4	DC Jack
5 - 6	Host MCU

Table 16 - Power Source Selection

The selected power source will serve as the system power, supporting the onboard DC-DC converter and LED backlight drivers.

5.2 Backlight LED Current Configuration

The VM816C module includes an onboard backlight LED driver circuit utilizing the Texas Instruments TPS61500 LED Driver. This driver can power up to four 3W LEDs with a 5V input or up to eight 3-W LEDs with a 12V input.

The LED driver is preconfigured to deliver an output current of 42.5mA with an over-voltage protection (OVP) threshold of 27V. Backlight current is set low to allow the system to operate with a 5V input power source (e.g., a standard USB port) while maintaining adequate LCD backlight brightness.

Developers can adjust the output current and OVP settings to meet the requirements of specific LCD panels or achieve higher brightness levels by following the instructions provided below.

Reconfiguration Instructions

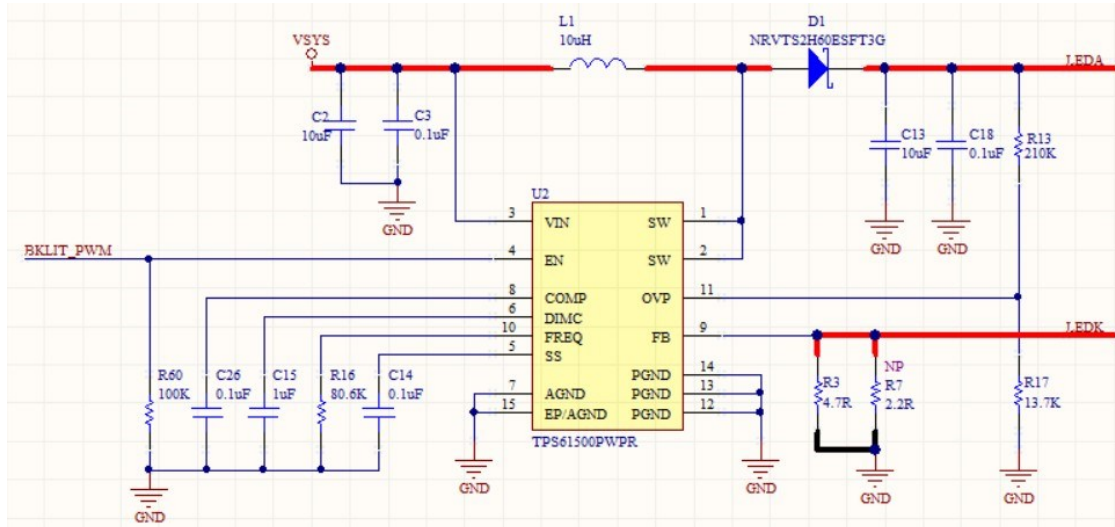

Figure 10 – LED Backlight Driver Circuit

Input power source Selection:

The driver utilizes the system power from the input source and regulates the output voltage to provide the necessary current for the backlight LEDs. For increased brightness or larger LCD panels, it is recommended to power the VM820C with a higher input voltage, such as a 12V supply via the DC jack.

Over Voltage Protection (OVP) Calculation:

OVP prevents damage to the driver under no-load conditions and should be set higher than the maximum forward voltage of the LED backlight. Developers can change the OVP of LED driver by changing resistor values R13 or R17 as shown in Figure 10 – LED Backlight Driver Circuit by using Equation 1 to calculate the new OVP value:

$$V_{ovp} = 1.229V \times \left(\frac{R13}{R17} + 1 \right)$$

Equation 1 - LED Driver OVP Calculation

Programming LED Current Calculation:

Developers can increase LED current by changing resistance on driver's FB pin. Use Equation 2 stated below to calculate the total resistance R_T required for setting LED current:

$$I_{LED} = \frac{V_{FB}}{R_T}$$

Equation 2 - LED Current Calculation

Voltage at feedback pin V_{FB} is fixed at 200mV.

Implementation Options:

With total resistance calculated, developers can either

- Replace R3 with a resistor of value R_T .
- Alternatively, calculate the required value of R7 using
- Equation 3 and mount the resistor on R7, the empty footprint provided for this purpose.

$$R_T = \frac{R_{13} \times R_{17}}{R_{13} + R_{17}}$$

Equation 3 - Parallel Resistor Calculation

Refer to the Texas Instruments [TPS61500 datasheet](#) for detailed explanations and implementation instructions.

Developers can further adjust the LCD panel's brightness by regulating the current through ILED, achieved by varying the backlight PWM signal connected to the driver's enable pin. For detailed instructions on controlling this pin, please refer to the [BT820 datasheet](#).

6 VM820C Hardware Setup

By pairing the VM820C module with the MN820 SoM board, developers can explore the operation of BT820 EVE IC, evaluate its performance, and assess its capabilities before integrating the IC or SoM into their products. This section provides a brief overview of setting up the VM820C for development.

Figure 11 below shows setup for BT820 development modules driving LVDS display panel with active speakers and options for different host interface.

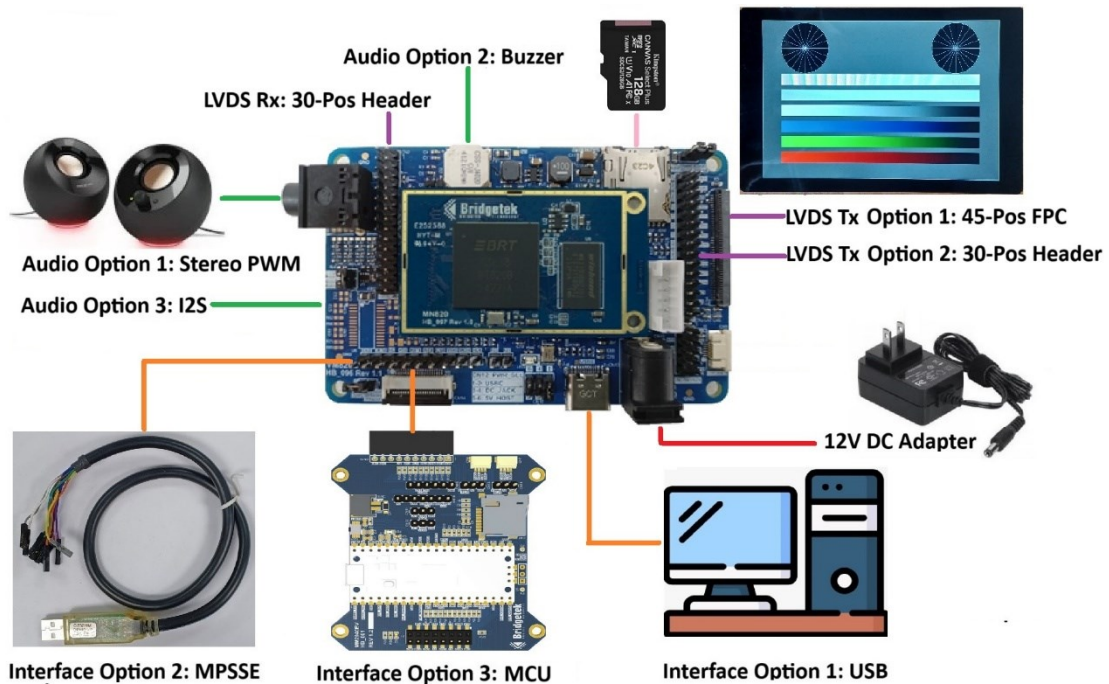

Figure 11 - Setting up VM820C

6.1 Communication Interface

The VM820C development module offers multiple options for developers to communicate with the BT820 EVE. Below are the available methods:

1. FT4222H

The onboard FTDI FT4222H USB-to-QSPI bridge circuit provides the simplest way to communicate with the BT820 EVE.

2. MPSSE

Developers can use the Multi-Purpose Synchronous Serial Engine (MPSSE) available in some FTDI devices (e.g. FT232H, FT2232H, FT4232H). The FT232H is available in cables such as the C232HM-EDHSL-0 (5V) and C232HM-DDHSL-0 (3.3V). This interface bridges a PC USB port to an SPI interface.

3. Host MCU with SPI Interface

Developers can also use their preferred host MCU that supports SPI/QSPI communication. The MCU can interface with the VM820C through connector J1 and J2, which are 2.54mm pitch headers, or through CN14, a 20-position 0.5mm pitch FPC connector.

Bridgetek provides a ready-made MCU module, the MM2040EV Pico Adaptor Board, featuring the Raspberry Pi Pico RP2040, specifically designed for this purpose.

When the host PC is connected via the onboard FT4222H bridge IC and the developer's MCU host or MPSSE cable is connected through the SPI connector CN14/J1, users can short JP3 to put the FT4222H into reset mode. This allows the MCU host or MPSSE to take priority in controlling the EVE.

On the other hand, when the host PC is connected via the onboard FT4222H and the Bridgetek MM2040EV is used as the host MCU, the MCU host automatically takes control of EVE without requiring JP3 to be shorted. This occurs because the "HOST_DET#" pin on the 10-pin host connector is grounded by the MM2040EV, achieving the same effect as shorting JP3 and allowing the external MCU host to control the SPI bus to the EVE.

6.2 Selecting Power Source

When powering the system via USB-C (FT4222H interface) or 5V_Host (MPSSE or Host_MCU), the maximum power supply is limited to 500mA at 5V. In cases where large LCD panels are used or the power demand exceeds the available supply, it is strongly recommended to provide a 12V power supply through the DC jack connector for the development module.

6.3 LVDS Transmit Interface

The VM820C development module routes the dual-channel LVDS transmit signals to two output headers and FPC connectors as follows:

1. 30 Pin 2mm Pitch Header

This header uses the standard pin definition for LVDS transmit signals, commonly used by LCD panels larger than 10 inches.

Since it does not include LEDA/K signals, the VM820C includes a 6-pin, 2mm power connector to supply power for panels connected via this header.

2. 45-Position 0.5mm pitch FPC Connector

This connector, model *FH34SRJ-45S-0.5SH (50)* from Hirose, is a 45-position, 0.5mm pitch FPC connector with top and bottom contacts. The 45-position design was chosen because most 10" LVDS panels with 45-position connectors have consistent pin definitions from pin 5 to pin 45. In contrast, 50-position connectors lack standard pin definition, making the 45-position option compatible with a broader range of LCD panels.

Table 17 provides a selection of LCD panels that feature a 45-position FPC connector, which aligns directly with the 45-position connector on CN4.

Manufacturer	Part No.	Size	Resolution	Display Interface	Official Website
MICROTECH TECH.	MTF101U G18A-V1	10.1"	1920 * 1200	LVDS-45	MicroTech official website
MIDAS DISPLAYS	MDT1010I 5IH	10.1"	1920 * 1200	LVDS-45	MIDAS DISPLAY's official website
	MDT1010I IH/C-	10.1"	1920 * 1200	LVDS-45	MIDAS DISPLAY's official website
TSD	TST101W UBH-107	10.1"	1920 * 1200	LVDS-45	TSD official website

Table 17 – Compatible LCD List

6.4 Audio Interface

The VM820C development module provides 3 types of audio interface, stereo sigma-delta PWM interface, buzzer and I2S interface:

1. Stereo Sigma Delta PWM Interface:

The VM820C module includes a stereo tri-state low-pass filter that converts the BT820's sigma-delta PWM signals into analog audio signals. These signals are available to users through a three-pin audio socket, allowing active speakers to be connected.

2. Buzzer Interface:

The module also includes a built-in buzzer circuit, ideal for alarms and notifications. This feature is well-suited for evaluating the BT820's built-in sound synthesizer capabilities.

3. I2S Interface:

The VM820C module is designed to accommodate a DAC circuit based on the Texas Instruments PCM5121PW audio DAC. This circuit is not pre-mounted on the board, requiring developers to install the necessary components for evaluations. Please note that the BT820 can only operate as an I2S slave, with the BCLK and LRCLK signals supplied by a DAC configured as the master.

6.5 Memory Interface

The VM820C module offers two methods for accessing non-volatile memory:

1. Onboard NAND Flash:

The VM820C is equipped with 1 Gbit of onboard NAND flash memory, utilizing the W25N01GVZEIG, a QSPI 104MHz 8-WSON chip from Winbond Electronics.

2. SD Micro Card Slot:

An alternative source of non-volatile memory is the SD micro card slot. Developers can insert an SD card, which is accessible by the EVE through the SDIO interface.

7 Electrical Specifications

Parameter		MIN	TYP	MAX	UNIT
USB_5V	Input voltage range	4.5	5.0	5.5	V
Host_5V	Input voltage range	4.5	5.0	5.5	V
DC_IN	Input voltage range	4.5	12	13.5	V
VCC3V3	Output voltage range	3.1	3.3	3.5	V
Icc_USB_5V *Note 1	Operating current into USB_5V	-	397	-	mA
Voh	Output Voltage High	2.4	-	-	V
Vol	Output Voltage Low	-	-	0.4	V
Vih	Input High Voltage	2.0	-	-	V
Vil	Input Low Voltage	-	-	0.8	V
T	Operating temperature	-20	-	+70	°C

Table 18 - Operating Voltage and Current

Note:

Operating current was measured using the Microtech 10.1" MTF101UG18A-V1 LVDS LCD panel with the backlight current (ILED) set to 42.5 mA while displaying a test card image.

8 Mechanical Dimensions

8.1 VM820C PCB Dimensions

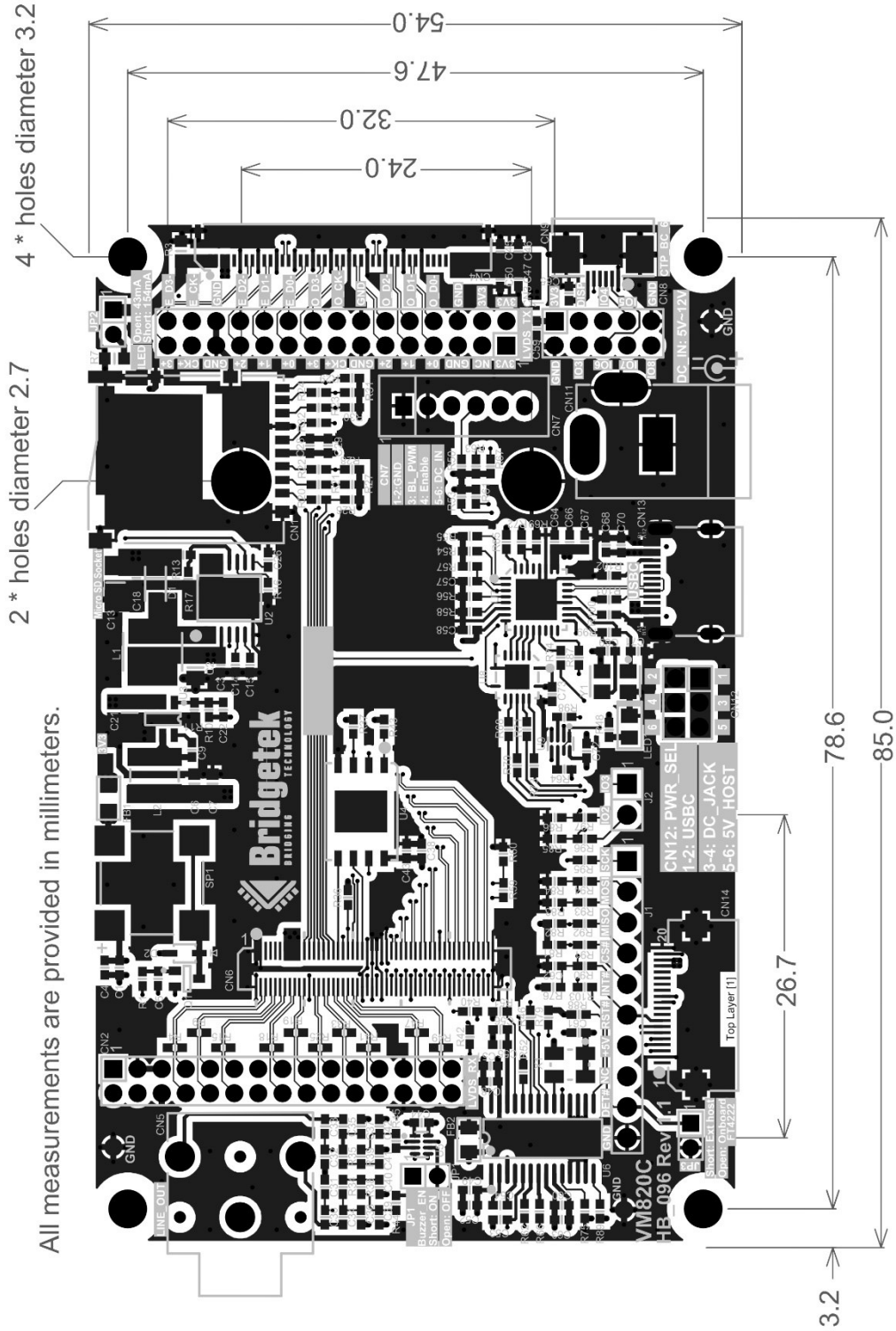

Figure 12 – VM820C PCB Dimensions

9 Software Setup Information

EveApps-BT82X is a collection of applications designed for the BT82X Eve Series chip. It offers sample applications, all developed in ANSI C, with complete source code included. Below are the download links for EveApps-BT82X and the necessary supporting software.

EveApps-BT82X:

- [EveApps-BT82X](#)

Required Supporting Software for EveApps-BT82X:

- [Visual Studio 2019 \(Free Download\)](#)

9.1 Running EveApps-BT82X

1. Download and install **Visual Studio**, ensuring that C/C++ tools are included.
2. Download and extract the latest EveApps-BT82X package.
3. Launch the sample application **SampleApp_MSVC.sln** located under SampleApp folder. Figure 13 - Running SampleApp_MSVC.sln in Visual Studio
4. demonstrates SampleApp_MSVC.sln being executed in Visual Studio.

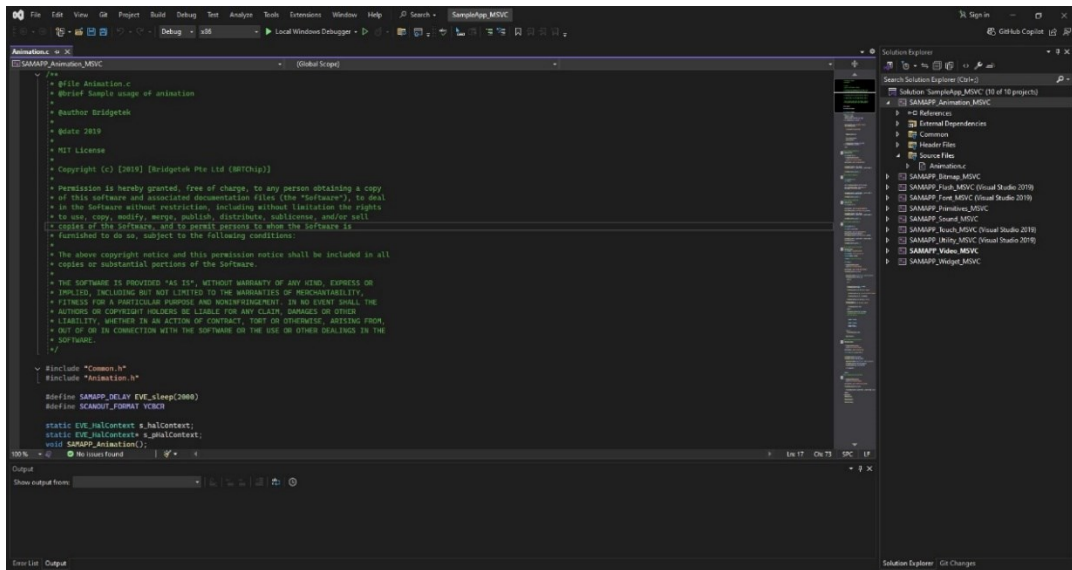
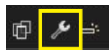

Figure 13 - Running SampleApp_MSVC.sln in Visual Studio

9.2 Configuring the Communication Interface

1. Select desired sample application.
2. Open the project properties by pressing **Alt+Enter** or clicking the  properties icon.
3. Navigate to **Configuration Properties> C/C++ > Preprocessor** and modify the **Preprocessor Definition**:

- If using FT4222H, set platform to "EVE_PLATFORM_FT4222".
 - If using MPSSE, set platform to "EVE_PLATFORM_MPSSE".
4. Figure 14 shows an example of the communication interface set to FT4222H.

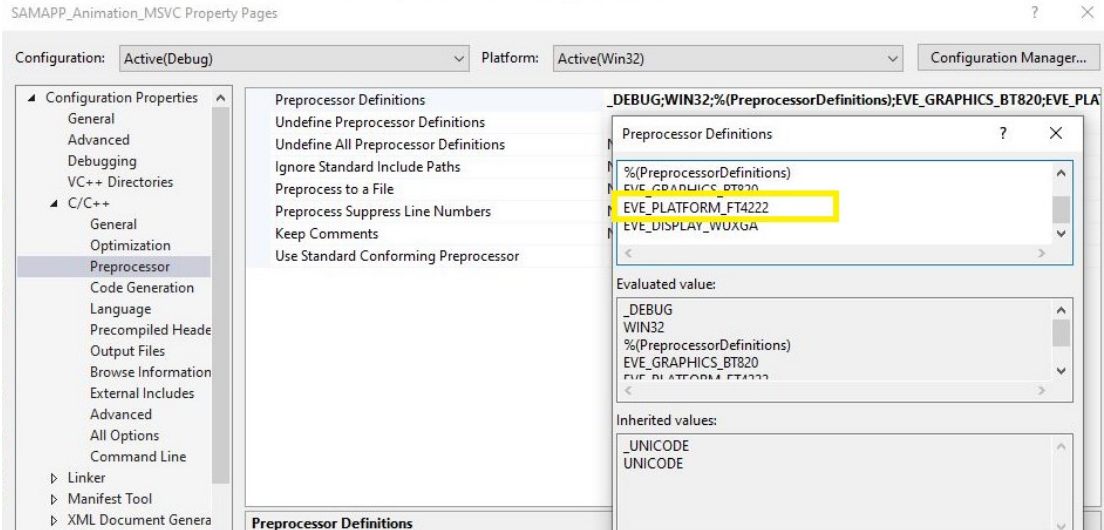

Figure 14 - Communication Interface set to FT4222H

9.3 Running Sample Codes

1. Choose your preferred sample application (refer to Figure 15).

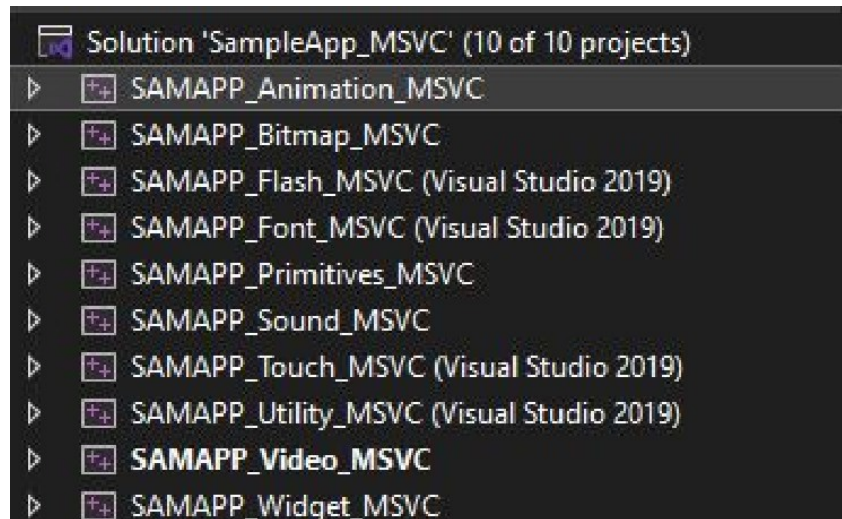



Figure 15 - Available Sample Applications

2. Right-click on the desired application and choose **Set as Startup Project**.
3. Press "F5" or click  icon to build and execute the application.

9.4 Example of VM820C running EVEApps-BT82X with 10.1" 1920 x 1200 LCD Panel

This example demonstrates the use of a MicroTech 10" TFT display (MTF101UG18A-V1) with a capacitive touch panel (MTP101GGY-01) for display and touch functionality. The PC host controller communicates with the BT820 EVE chip via the built-in FT4222H bridge IC.

Hardware Setup

1. Ensure VM820C jumpers are set to default positions.
 - JP1 – Shorted: Enables the on-board buzzer
 - JP2 – Open: Sets the LED backlight current to 43mA
 - JP3 – Open: Selects the built-in FT4222H
 - CN12 – Short pins 1-2: Powers the board via USB-C.
2. Connect the LCD display 45-pin FPC cable to CN4.
3. Connect the LCD touch 6-pin FPC cable to CN9.
4. Connect USB C cable from PC to CN13 to power the VM820C.



5. Figure 16 illustrates the VM820C setup with the 10.1" 1920x1200 LCD and capacitive touch panel.

Figure 16 - VM820C Setup with 10.1" 1920 x 1200 LCD Panel

6. Start running EveApps-BT82X following steps starting from section 9.1.
7. Figure 17 shows VM820C running the **SAMAPP_Video_MSVC** application.



Figure 17 - VM820C running SAMAPP_Video_MSVC

10 Disclaimer Notice: Use of Third-Party Software or Websites

We may recommend use of software or web sites that are owned or operated by other companies. We offer or facilitate this recommendation by hyperlinks or other methods to aid your access to the third-party resource. While we endeavour to direct you to helpful, trustworthy resources, we cannot endorse, approve, or guarantee software, information, products, or services provided by or at a third-party resource or track changes in the resource. Thus, we are not responsible for the content or accuracy of any third-party resource or for any loss or damage of any sort resulting from the use of, or for any failure of, products or services provided at or from a third party resource.

We recommend these resources on an "as is" basis. When you use a third party resource, you will be subject to its terms and licenses and no longer be protected by our privacy policy or security practices, which may differ from the third policy or practices or other terms. You should familiarize yourself with any license or use terms of, and the privacy policy and security practices of, the third party resource, which will govern your use of that resource.

11 Contact Information

Refer to <https://brtchip.com/contact-us/> for contact information.

Distributor and Sales Representatives

Please visit the Distribution Network – IC & Module (brtchip.com) page for the contact details of our distributor(s) and sales representative(s) in your country.

System and equipment manufacturers and designers are responsible to ensure that their systems, and any Bridgetek Pte Ltd (BRT Chip) devices incorporated in their systems, meet all applicable safety, regulatory and system-level performance requirements. All application-related information in this document (including application descriptions, suggested Bridgetek devices and other materials) is provided for reference only. While Bridgetek has taken care to assure it is accurate, this information is subject to customer confirmation, and Bridgetek disclaims all liability for system designs and for any applications assistance provided by Bridgetek. Use of Bridgetek devices in life support and/or safety applications is entirely at the user's risk, and the user agrees to defend, indemnify, and hold harmless Bridgetek from any and all damages, claims, suits, or expense resulting from such use. This document is subject to change without notice. No freedom to use patents or other intellectual property rights is implied by the publication of this document. Neither the whole nor any part of the information contained in, or the product described in this document, may be adapted, or reproduced in any material or electronic form without the prior written consent of the copyright holder. Bridgetek Pte Ltd, 1 Tai Seng Avenue, Tower A, #03-05, Singapore 536464. Singapore Registered Company Number: 201542387H.

Appendix A – References

Document References

[BT820 Datasheet](#)

[TPS61500 Datasheet](#)

Acronyms and Abbreviations

Terms	Description
BCLK	Bit Clock
CTP	Capacitive Touch Panel
DAC	Digital Analog Converter
DC	Direct Current
EVE	Embedded Video Engine
FB	Feedback
FPC	Flexible Printed Circuit
GPIO	General Purpose Input Output
IC	Integrated Circuit
I2S	Inter-Integrated Circuit Sound
LCD	Liquid Crystal Display
LED	Light Emitting Diode
LEDA	Light Emitting Diode Anode
LEDK	Light Emitting Diode Cathode
LRCLK	Left Right Clock
LVDS	Low Voltage Differential Signaling
MCU	Micro Controller Unit
MPSSE	Multi-Purpose Synchronous Serial Engine
NAND Flash	“NOT AND” Flash
OVP	Over Voltage Protection
PC	Personal Computer

PCB	Printed Circuit Board
PCBA	Printed Circuit Board Assembled
PWM	Pulse Width Modulation
QSPI	Quad Serial Peripheral Interface
SD Card	Secure Digital Card
SoM	System On Module
SPI	Serial Peripheral Interface
USB	Universal Serial Bus
VFB	Feedback Voltage

Appendix B – List of Tables & Figures

List of Tables

Table 1 - Ordering Information.....	2
Table 2 – CN2 Pinout	8
Table 3 – CN3 Pinout	9
Table 4 – CN4 Pinout	11
Table 5 – CN6 Pinout	13
Table 6 – CN7 Pinout	13
Table 7 – CN8 Pinout	14
Table 8 – CN9 Pinout	14
Table 9 – CN12 Pinout	15
Table 10 – CN14 Pinout.....	15
Table 11 – J1 Pinout	16
Table 12 – J2 Pinout	16
Table 13 – JP1 Pin Options	16
Table 14 – JP2 Pin Options	16
Table 15 – JP3 Pin Options	16
Table 16 - Power Source Selection.....	21
Table 17 – Compatible LCD List.....	25
Table 18 - Operating Voltage and Current.....	27

List of Figures

Figure 1 – VM820C Base Board PCBA – Front View	5
Figure 2 – VM820C Base Board PCBA – Back View	5
Figure 3 – VM820C PCB Top Layer.....	7
Figure 4 – VM820C PCB Bottom Layer.....	7
Figure 5 - Power and Audio Circuit.....	17
Figure 6 – Host Interface.....	18
Figure 7 – Memory and IO Interface	19
Figure 8 – Assembly Drawing.....	20
Figure 9 - Power Source Selection Header	21
Figure 10 – LED Backlight Driver Circuit	22
Figure 11 - Setting up VM820C	24
Figure 12 – VM820C PCB Dimensions.....	28
Figure 13 - Running SampleApp_MSVC.sln in Visual Studio.....	29
Figure 14 - Communication Interface set to FT4222H.....	30
Figure 15 - Available Sample Applications.....	30
Figure 16 - VM820C Setup with 10.1" 1920 x 1200 LCD Panel	31

Figure 17 - VM820C running SAMAPP_Video_MSVC 32

Appendix C – Revision History

Document Title: VM820C Datasheet
Document Reference No.: BRT_000441
Clearance No.: BRT#218
Product Page: <https://brtchip.com/ic-module/product-category/products/>
Document Feedback: [Send Feedback](#)

Revision	Changes	Date
Version 1.0	Initial Release	16-01-2025