

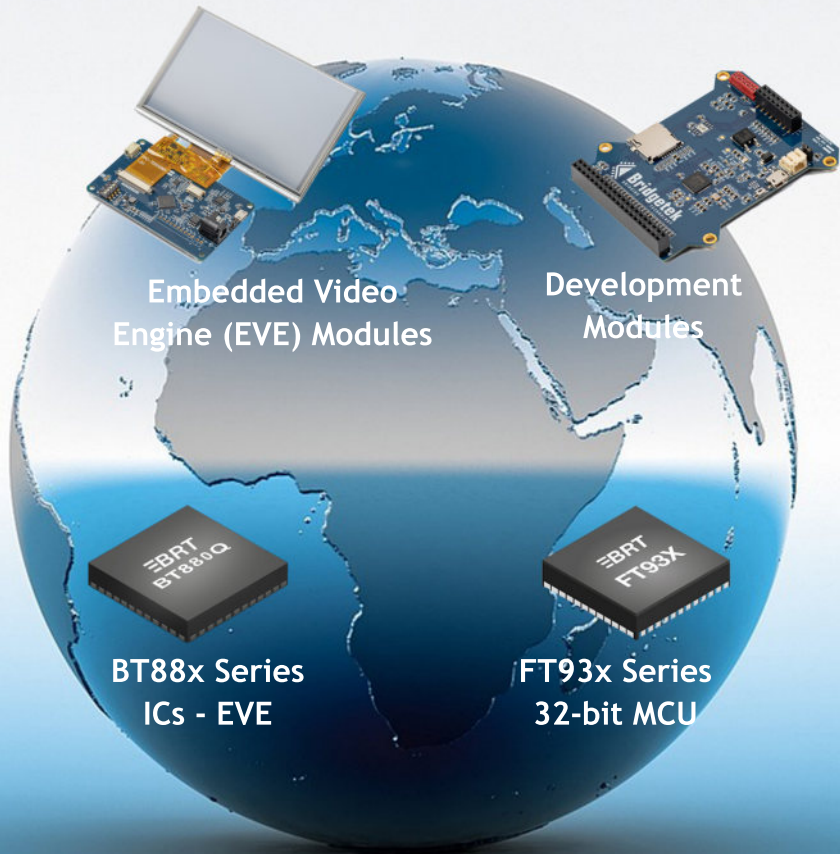

Bridgetek
BRIDGING TECHNOLOGY



**Embedded Video
Engine (EVE) Modules**

**Development
Modules**

**BT88x Series
ICs - EVE**

**FT93x Series
32-bit MCU**

Display Solutions & Microcontrollers



“By spinning our Microcontroller units and Human Interface divisions into a new company brand Bridgetek, we will be much better positioned, both strategically and logisticly speaking, to explore the multitude of opportunities now opening up within contemporary embedded design.”

“Rather than being spread across a large scope of activities and thus too diluted to be truly effective, the separate entities of FTDI and Bridgetek will be able to attend to their respective markets and bring real value to customers,”

states Founder and CEO, Fred Dart

EVE, THE EMBEDDED VIDEO ENGINE

Bridgtek has redefined the cost and quality paradigm for graphic user interface (GUI) development with the introduction of the FT8XX range of display products with Embedded Video Engine (EVE) technology. The EVE family combines display, audio and touch into a single chip, providing an optimized solution with high quality graphics that output to 1/16th pixel resolution for WVGA, VGA, SVGA (FT81x)), WQVGA and QVGA (FT80x) TFT display panels. The first device in the series, the FT800, launched in 2013 and took the titles of British Engineering Excellence 'Electronic Product of the Year' and Elektra 'Digital Semiconductor of the year', within the same year, where the product was described as providing 'versatility and innovation' and 'the technological capabilities with efficiencies that differentiate it from its competitors'.

With its revolutionary EVE technology deploying an object-oriented approach, the series is capable of simplifying the implementation of intelligent displays - reducing bill of material costs, power budget, board space, and development time.

The wide range of products includes an extensive choice of development systems including the 'Basic' series of modules which feature and SPI interfaced subsystem, the 'Plus' series of modules providing an Arduino-compatible ecosystems and the 'ME' series of daughter boards for Bridgtek's FT90x 32bit MCU series. In addition to this, an extensive library of technical documentation, application sample software and design tools provide a simple solution for engineers to further shorten design cycles and reduce BOM costs.

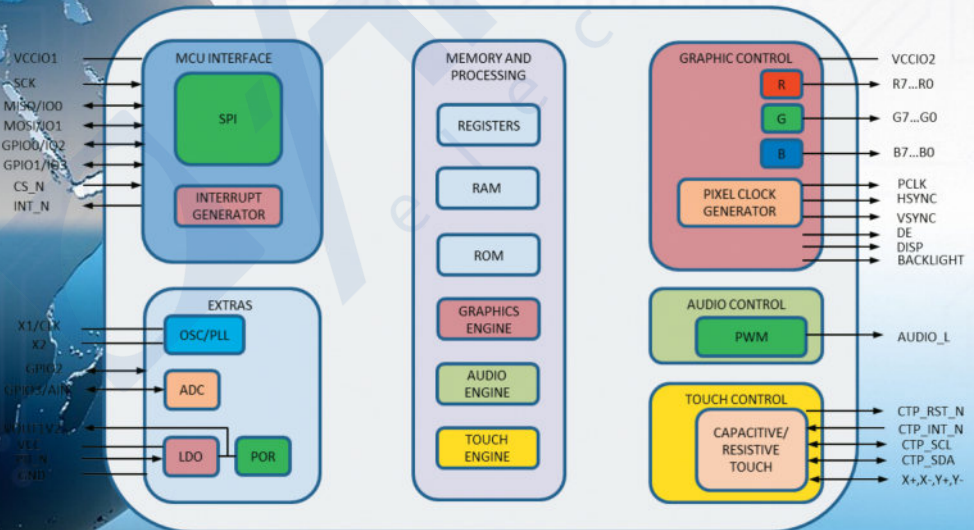

EVE IC SOLUTIONS

Bridgetek offers a comprehensive range of ICs for EVE solutions:

	FT800/1 (EVE)	BT880/1	FT810/1 (EVE2)	FT812/3 (EVE2)	BT815/6 (EVE3)	BT817/8 (EVE4)
Target Display Resolution	QVGA (320*240) WQVGA (480*272) HVGA (480*320)	QVGA (320*240) WQVGA (480*272) HVGA (480*320) Bar-Type display e.g. 800*160, 1024*120	HVGA (480*320) VGA (640*480) WVGA (800*480) SVGA (800*600)	HVGA (480*320) VGA (640*480) WVGA (800*480) SVGA (800*600)	HVGA (480*320) VGA (640*480) WVGA (800*480) SVGA (800*600)	WVGA (800*480) SVGA (800*600) WSVGA (1024*600) WXGA (1280*800)
Max Pixels Per Line	512	2048	2048	2048	2048	2048
Display Interface	RGB666	RGB666	RGB666	RGB666, RGB888	RGB666, RGB888	RGB666, RGB888
Touch Function	800 – Resistive 801 - Capacitive	880 – Resistive 881 - Capacitive	800 – Resistive 801 - Capacitive	812 – Resistive 813 - Capacitive	816 – Resistive 815 - Capacitive	818– Resistive 817 - Capacitive
Audio output	PWM	PWM	PWM	PWM	Sigma-Delta	Sigma-Delta
Host Interface	SPI/I2C	SPI/QSPI	SPI/QSPI	SPI/QSPI	SPI/QSPI	SPI/QSPI
90° Screen Rotation	No	Yes	Yes	Yes	Yes	Yes
Object Memory Size	256 kB	256 kB	1 MB	1 MB	1 MB	1 MB
External Memory Support	No	No	No	No	Up to 256 MB	Up to 256 MB
Adaptive Framerate	No	No	No	No	Yes	Yes
Adaptive HSYNC	No	No	No	No	No	Yes
Dedicated PCLK PLL	No	No	No	No	No	Yes
2X Pixel Mode	No	No	No	No	No	Yes
Non Square Pixel	No	No	No	No	No	Yes
Co-Processor	32-bit RISC 48MHz	32-bit RISC 60MHz	32-bit RISC 60MHz	32-bit RISC 60MHz	32-bit RISC 72MHz	32-bit RISC 72MHz
Image Decoder	DXT1, JPEG	DXT1, JPEG, PNG	DXT1, JPEG, PNG	DXT1, JPEG, PNG	DXT1, JPEG, PNG, ASTC	DXT1, JPEG, PNG, ASTC
Hardware Acceleration	No	JPEG	JPEG	JPEG	JPEG, ASTC	JPEG, ASTC
Video Playback	No	Motion JPEG	Motion JPEG	Motion JPEG	Motion JPEG	Motion JPEG
Animation Playback	No	No	No	No	Yes	Yes
GPIOs	3	3	3	5	5	5
Package	QFN48	QFN48	QFN48	QFN56	QFN64	QFN64

All devices require 3V3 power.

All devices IO are 1.8V to 3V3

All devices operate over -40oC to +85oC

All devices support mono audio output

All devices support backlight control for power saving

EVE DEVELOPMENT PLATFORMS

The EVE series includes a range of development modules in addition to a number of LCD and Bezel options. The modules are provided in a variety of form factors, and are designed specifically to assist with the design and development

VM880C - Credit Card Sized Module

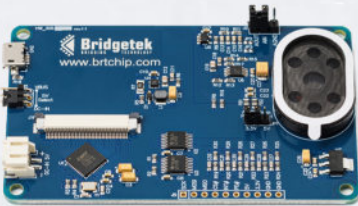

The VM880C is a development module for BT880 which is used to develop and demonstrate the functionality of the BT880 Embedded Video Engine, EVE. This module behaves as an SPI slave and requires an SPI Master for proper micro-controller interfacing and system integration. VM880C module supports display, touch and audio interfaces. Users can choose to connect to different LCD screens as long as they meet the BT880 technical specification and fit the VM880C LCD connector. Typical TFT displays supported: 4.3" 480x272 TFT LCD with 40-pin FPC or 5" 480x272 TFT LCD with 40-pin FPC.

VM800B - FT800 Basic Modules with Bezel Enclosure



The VM800B Basic modules expand on the VM800C product by offering the same functionality, and provide a high quality display system in an elegantly designed, form-fitted bezel. Offered in black or pearl colours, these display sub-systems provide the engineer with a low priced option which can shorten development time whilst enabling a production finished look and are designed to control 3.5", 4.3" or 5" TFT displays.

The VM800B offers these innovative features with a resistive touch display.

VM816C50/CU50 - BT816 Credit Card Sized Module

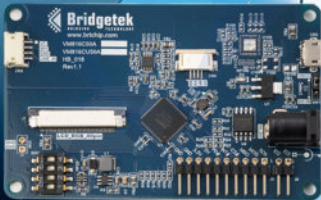

The VM816C50/CU50 modules are credit card sized and use the highly integrated BT816 - EVE graphical controller. They are available with either SPI (C50) or USB (CU50) interfaces supporting a 5" resistive touch screen, optionally available with the module. The backlight output is configurable up-to 100mA. The boards can be powered at 3.3V or 5V and have an audio out speaker connection.

EVE DEVELOPMENT PLATFORMS

VM800P - FT800 Plus Modules (Arduino compatible)



The MM800P 'Plus' modules further extend system integration by providing a complete video subsystem with an embedded microcontroller in resistive touch variant. In addition to the features supplied with the basic modules, this system provides an in-built MCU, the ATMEGA328P, which is supported by Arduino libraries. Further functionality is provided in the form of a Real Time Clock (RTC) with battery back up and and SD card connector plus preloaded 4GB SD Card, allowing for demonstration code to be easily sampled. Plus in daughter cards are available to expand the IO capability to include GPIO, RS232, RS422, RS485 and Ethernet, promoting improved connectivity and the ability to transmit over longer distances.

	VM880C	VM800B	VM816C50/CU50	VM800P
Main EVE Controller	BT880	FT800	BT816	FT800
Display Included	Optional	Y	Optional	Y
Display Size	3.5", 4.3" and 5"	3.5", 4.3" and 5"	5"	3.5", 4.3" and 5"
Bezel Enclosure	N	Y	N	Y
Bezel Color	N/A	Black/Pearl	NA	Black/Pearl
Touch function	Resistive touch	Resistive touch	Resistive touch	Resistive touch
Audio Speaker	Y	Y	N	Y
Backlight LCD driver	Y	Y	Y	Y
Embedded MCU	N	N	N	Embedded ATMEGA 328P MCU
Host Interface	SPI	SPI	SPI/USB	N/A
Daughter Board Interface	N	N	N	Y
Micro SD	N	N	N	Y (4GB)
Battery Backed RTC	N/A	N/A	N/A	Y
Power Source	3.3V or 5V	3.3V or 5V	3.3V or 5V	5V
Module Series				

ACCESSORIES FOR VM800P

An extensive range of expansion cards designed to support the VM800P modules allow EVE to connect to a wider system and become the focal point of its control and display interface. With a simple Arduino SPI interface accessed over the VM800P MicroMaTch connectors, access to Serial, Control and even Ethernet systems can be achieved.

Other EVE Accessories

VA-FC-STYLUS1 Resistive Touch Screen Pen Stylus



ME81x HMI Modules

The ME81x modules provide a display, audio and touch HMI companion for any MCU with USB, SPI or QSPI interfacing capabilities. Included in the module assembly are Bridgetek's FT81x graphics controllers with Embedded Video Engine (EVE) technology, driving full colour TFT panels with either resistive or capacitive touch, ranging from 3.5" to 5" in size. The module is fully equipped with a black colour form-fitted bezel, LCD backlight control, audio buzzer and an EVE IO connector to interface with the MM900EVxx modules or custom MCU boards.

Bridgetek provides a set of design examples, demonstrating support for FT90x (our 32-bit SuperBridge MCU offering) + FT81x total solutions. Additionally the EVE Screen Editor and EVE Screen Designer development utilities are now available with support for EVE2 directly from our website. These utilities are provided to assist designers wishing to experiment with creating display lists, utilising a simple "drag and drop" method to control the EVE graphic controller.

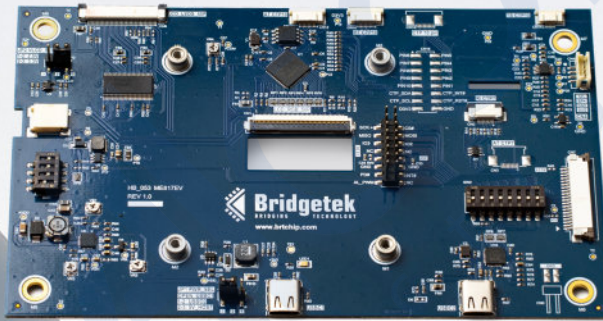

	IDM2040-7A	MM2040EV	ME817EV	ME812A-WH50R	ME812AU-WH50R	ME813AU-WH50C
Controller	BT817Q	BT817Q	BT817Q	FT812Q	FT812Q	FT813Q
Display	7"	Up to 10.1"	Up to 10.1"	5"	5"	5"
Display type				Horizontal	Horizontal	Horizontal
Resolution	800x480	1280x800 or 1024x600	1280x800 or 1024x600	800x480	800x480	800x480
Touch	Capacitive	Capacitive		Resistive	Resistive	Capacitive
Interface	USB	USB or SPI/QSPI	USB or SPI/QSPI	SPI/QSPI	USB	USB
Audio out	External speaker			<u>Microspeaker</u>	<u>Microspeaker</u>	<u>Microspeaker</u>
Bezel				Yes	Yes	No
Color				Black (-BK)	Black (-BK)	Black (-BK)

EVE DEVELOPMENT SUPPORT

Bridgetek provides the ability to work on projects utilising a variety of tools and programming techniques. Examples are provided for a variety of different MCU families including ATMEL (Arduino) Freescale, PIC and ARM.

HAL - Hardware Abstraction Layer

The HAL takes all the low level HEX values for each function call and wraps them up to a high level function call to enable the user to focus on the display list contents without too much concern for how the SPI traffic is created and dispatched. The HAL supports MPSSE cables and Arduino PCBs and provides an excellent starter platform.

Arduino Library

This library has been created in a syntax which will be familiar to Arduino users, in order to enable rapid prototyping of FT800/FT801 applications with Arduino Pro and Uno form factors.

EVE Emulator Library

This is a PC based tool which allows simulation of display list commands. The simulator provides the user with the ability to rapidly experiment with changes to their display list, without the need for hardware. The user can then become familiar with the EVE display list and create attractive, high impact displays before porting code to the system processor.

Arduino Library (AN_318)

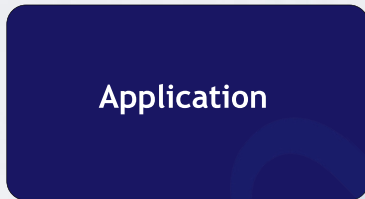

HAL Structure (AN_246)

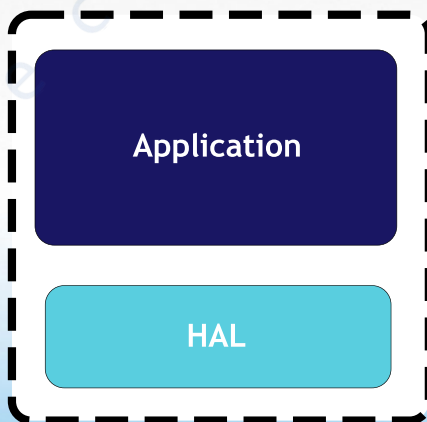

SPI

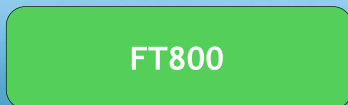

EVE APPLICATION EXAMPLES

As engineers come to understand EVE's programming language, the recommended starting point for design development is through the use of the Sample Application. These detailed software scripts provide easy-to-use code, where the designer can start to experiment with the EVE language and Basic series development kits.

By loading the sample application into a C compiler (eg. Visual Studio), connecting/enabling a USB to SPI cable accessory (eg. VA800A-SPI) and connecting it to the VM80X basic kits, the user can create a PC target environment where they can readily interface to the EVE device and render graphics onto the display (ie through the use of break-points and executes). When the designer is comfortable with EVE's instruction set, the complete display description is created via text entry, through the use of the Sample Application and Bridgetek reference examples. This operation is most likely to be accomplished in the C compiler of the system host `micro-controller`.

A range of sample applications are available to demonstrate how to initialize the EVE Device and develop display lists of primitive objects. These can be used as building blocks to create vibrant and dynamic images. Projects can be realised from a variety of tool and programming techniques, supporting anything from very basic EVE functions to sophisticated, animated and interactive demos.

Hardware

SELECT MCU

SPI OR I2C
GPIO for PD_n
INTERRUPT INPUT

SELECT DISPLAY AUDIO AND TOUCH

SIZE=WQVGA, QVGA, UP TO 512 X 512
RESISTIVE TOUCH
AUDIO AMPLIFIER

Software

CONFIGURE MCU SPI INTERFACE

SET FOR MODE 0
MAX CLK 30MHZ
LITTLE ENDIAN DATA

WAKE UP THE FT800

- USE A GPIO LINE OF THE MCU TO SET PD_n (FT800 PIN 12) LOW
- WAIT 20ms
- SET PD_n HIGH
- WRITE 0x00 0x00 TO WAKE
- WRITE 0x44 0x00 0x00 TO ENABLE OSC.
- WRITE 0x62 0x00 0x00 TO SET FOR 48MHz
- READ DEVICE_ID REGISTER - VALUE 0x7C MEANS READY TO START

CONFIGURE THE SCREEN

- SET VERTICAL TIMING REGISTERS:
 - VOFFSET, VSYNC0, VSYNC1, VISIZE
- SET HORIZONTAL TIMING REGISTERS:
 - HOFFSET, HSYNC0, HSYNC1, HSZE
- SET THE TOUCH SENSITIVITY REGISTERS:
 - TOUCH_RZ, TOUCH_RZTHRESH
 - TOUCH_TAG, XY, TOUCH_TAG
- LEAVE PCLK AT 0 UNTIL READY TO DISPLAY

CONFIGURE THE AUDIO

CREATE DUMMY DISPLAY LIST & ENABLE

- CLEAR SCREEN TO WHITE OR BLACK BEFORE ENABLING DISPLAY FOR CLEAN STARTUP
- CLEAR COLOUR, RGB(255,255,255)
- CLEAR (1,1,1)
- DISPLAY
- SWAP_LIST
- ENABLE THE PCLK TO START DISPLAYING

CREATE APPLICATION DISPLAY LISTS

- CLEAR COLOUR, RGB(255,255,255)
- CLEAR (1,1,1)
- APPLICATION DATA
- DISPLAY
- SWAP_LIST

CREATE APPLICATION DISPLAY LISTS

NOTE EVERY ITEM ON THE LIST IS 32 BITS
NOTE A DISPLAY LIST ITEM MAY BE VISUAL
OR AUDIO

EVE DEVELOPMENT PLATFORMS

The EVE series includes a range of development modules in addition to a number of LCD and Bezel options. The modules are provided in a variety of form factors, and are designed specifically to assist with design and development



EVE Screen Editor

The EVE Screen Editor is a WYSIWYG GUI tool which enables engineers to study display commands interactively. It can also be utilised to access a number of various EVE development platforms (sch as the EVE Basic and Credit Card Series Development modules) via an MPSSE cable, without the need for any supplementary code to be written.

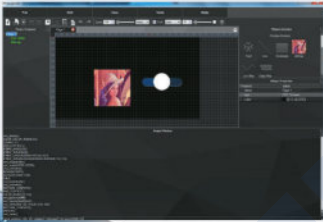

EVE Screen Designer

The EVE Screen Designer has been created specifically for User Interface (UI) designers. With this tool, designers can construct a stunning UI easily using widgets and images to replace the traditional full range graph UI design without any programming required.

Feature	Screen Editor	Screen
Widget concept	N	Y
Edit display list	Y	N
View display list	Y	Y
Zoom in/out widgets and screen	N	Y
Align widgets in screen	N	Y
Multi-Page (screen) design	N	Y
Grid assistance in screen	N	Y
Widgets multi-selection	N	Y
Widgets copy/cut/paste	N	Y
Screen copy/paste/move	N	Y
Undo/Redo	N	Y
Save Screen shot	N	Y
Rotate resize translate bitmap widget	N	Y

Feature	Screen Editor	Screen
Group the widgets	N	Y
Z-order of widgets	N	Y
Lock/unlock widgets	N	Y
Area multi widgets selection	N	Y
Multi-Language for UI	N	Y
Designed for	Programmers	Designers
Emulator Based	Y	Y
Project history	N	Y
Project Autosave	N	Y
Debug/step by step display list	N	Y
Hardware platform sync	Y	N
Pixel trace	Y	N
Register/Memory viewer	Y	N
Export to platform project	Y	N

Ultimate Bridging Solutions with 32-bit MCUs

Bridging technologies is the Bridgetek company mission, and our range of products and services are designed and manufactured to facilitate this. Our series of microcontrollers (MCUs) have been developed with key functionality to enable enhanced system performance and operational efficiency.

Based upon Bridgetek's FT32, high performance 32-bit RISC core, the FT90X series provides a plethora of connectivity options, making it the ideal choice for advanced technology bridging solutions. By executing instructions from shadow RAM, rather than flash memory, the FT90X can operate at true Zero Wait States (OWS) up to 100MHz and 310 DMIPS (at 100MHz) performance.

Using the industry standard GCC compiler, together with the Eclipse IDE, allows the FT90X to utilise a wide variety of third-party and open source software.

For projects with smaller pin count requirements, the FT93X series comes in a range of 48, 56 and 68 QFN packages.

The FT93X range allows various bridging options such as UART, SPI master/slave, I2C master/slave, RTC, DAC, ADC, USB device, PWM, SD host controller and debugger port.

Unique to this class of device is the hardware enabled USB engine which supports FTDI's USB engine in addition to all generic USB classes for rapid development of applications.

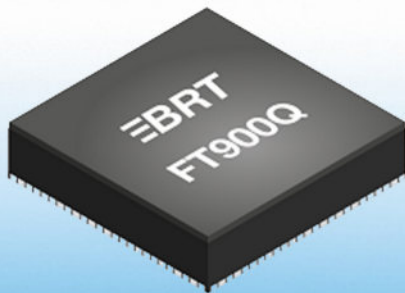

FT90X Series

The FT90X series has been developed for high speed, interface bridging tasks. With a parallel camera input, 10/100 Base-TX Ethernet interface, CAN bus, and USB2.0 Hi-Speed peripheral and host ports, this device offers excellent interconnect capabilities and fast data rates.

Enhanced features:

- 32 bit RISC architecture
- 256kB program/shadow memory
- High speed operation - 3.1 DMIPS per MHz
- 64kB data memory
- True Zero Wait State operation up to 100MHz
- USB DFU Bootloader

Standard features:

- Integrated Phase-Locked Loop (PLL) supports external crystal and clock source input
- 32.768kHz RTC clock support
- Four user timers with prescale and watchdog function
- 3.3V single supply operation
- Internal voltage regulator +1.2V to the digital core for lower power consumption
- Supports Battery Charging Specification, for USB2.0 High Speed peripheral port
- Integrated power-on-reset circuit
- Pb-free, RoHS packaging, 100QFN, 100LQFN, 76QFN and 80LQFP options

Digital connectivity:

- Direct camera input via a parallel data interface
- USB2.0 Hi-Speed (480Mbps) device controller with Battery Charge Detection (BCD)
- 10/100 BASE-TX Ethernet MAC and PHY: compliant with the IEEE 802.3/802.3u standards
- Two CAN 2.0 controllers for data transfer up to 1M bit/s
- I2S master/slave interface supporting up to 24b/192MHz
- Host SD controller compliant with standard specification V3.0, which supports UHS50 and UHS104 cards
- SPI master supports single/dual/quad modes
- Two SPI slaves support single data transfer with 25MHz clock
- UART interface configured as 1 Full UART or 2 basic UARTs (TX/RX/CTS/RTS)
- Two 12C bus interfaces can be configured as master or slave, with data transfers up to 3.4Mbps
- Supports eight separate PWM channel outputs with support for PCM 8-bit/16-bit stereo audio output

Analog connectivity:

- 7 input channel muxed to a single internal ADC
- Two 10 bit DACs

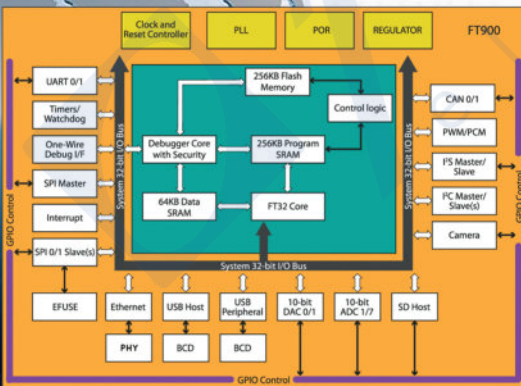

FT90X Series Device Solutions

Part Number	Package	CAN2.0	Ethernet 10/100M	Camera VGA	SD3.0	I2S Master and Slave	Others*
FT900Q	100QFN	Y	Y	Y	Y	Y	Y
FT900L	100LQFP	Y	Y	Y	Y	Y	Y
FT901Q	100QFN	-	Y	Y	Y	Y	Y
FT901L	100LQFP	-	Y	Y	Y	Y	Y
FT902Q	100QFN	Y	-	Y	Y	Y	Y
FT902L	100LQFP	Y	-	Y	Y	Y	Y
FT903Q	100QFN	-	-	Y	Y	Y	Y
FT903L	100LQFP	-	-	Y	Y	Y	Y
FT905Q	76QFN	Y	Y	-	-	-	Y
FT905L	80LQFP	Y	Y	-	-	-	Y
FT906Q	76QFN	-	Y	-	-	-	Y
FT906L	80LQFP	-	Y	-	-	-	Y
FT907Q	76QFN	Y	-	-	-	-	Y
FT907L	80LQFP	Y	-	-	-	-	Y
FT908Q	76QFN	-	-	-	-	-	Y
FT908L	80LQFP	-	-	-	-	-	Y

* UART, I2C, SPI, DAC, ADC, USB device, USB host, PWM

FT93X Series Device Solutions

Part Number	Package	UART	SPI	I2C	USB Device	DAC	ADC	SD	RTC	PWM Chan
FT930Q	100QFN	4	Master/ Slave	Master/ Slave	Y	Y	3	Y	Y	8
FT931Q	100LQFP	2	Master/ Slave	Master/ Slave	Y	Y	3	Y	Y	8
FT932Q	100QFN	2	Master/ Slave	Master/ Slave	Y	Y	3	Y	N	8
FT933Q	100LQFP	2	Master/ Slave	Master/ Slave	Y	Y	3	Y	N	8

FT90X Series Development Modules

FT9XX Development Modules

Based on Bridgetek's FT32 high performance, 32 bit RISC core, the FT90x series provides a plethora of connectivity options, making it the ideal choice for advanced technology bridging solutions. By executing instructions from shadow RAM, rather than flash memory, the FT9XX can operate at true Zero Wait States (OWS) up to 100MHz with 210 DMIPS performance.

MM900EV1B

The MM900EVxB series is a development module for Bridgetek's 32-bit high performance FT90X Revision C Microcontroller family, which is used to develop and demonstrate the functionality of the FT90X Embedded Microcontroller. These modules apply to home security systems, home automation systems, USB capability products, embedded multimedia application and other industrial control systems.

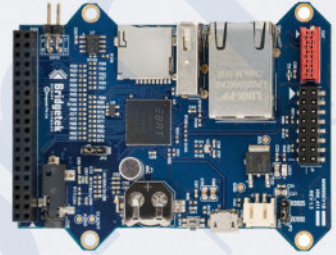

MM930Lite

The MM930Lite is a development module for Bridgetek's 32-bit high performance FT93x Microcontroller family, which is used to develop and demonstrate the functionality of the FT930 Embedded Microcontroller. This module is ideal for applications including home security systems, home automation systems, USB capability products, embedded multimedia application and other industrial control systems.

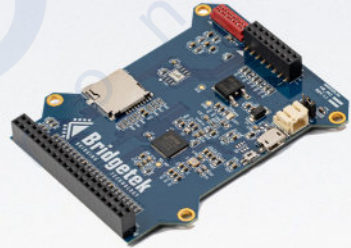

MM930Mini

The MM930Mini Module is a USB microcontroller development module in the Bridgetek product range. It utilizes the FT930Q bridge chip which can handle all USB signalling and protocols. It is ideal for development purposes to quickly prove functionality of adding USB to a target design.

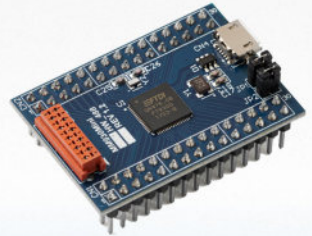

MM932LC

The MM932LC is a low cost development module for Bridgetek's 32-bit high performance FT93x Microcontroller family, which is used to develop and demonstrate the functionality of the FT932 Embedded Microcontroller. This module is ideal for simple applications including USB capability products, embedded multimedia applications and other industrial control systems.



FT9XX Series Development Tools & Software Support

A complete set of tools, from hardware development modules to software code editors, libraries, compilers and debuggers, are available now.

FT9XX Series Firmware Development

Bridgetek provides a development toolchain based on GNC/C++ and assembly compiler for the FT90X and the FT93X series. It is fully integrated with the open source Eclipse IDE with C/C++ Development Tooling (CDT). The FT9XX Eclipse integrated toolset includes sample applications to enable the ability to start a new project design quickly. An open source real time OS FreeRTOS is ported to the FT9XX and comes together with the toolchain.



Interface Driver Support

The toolchain is supported with a suite of free libraries to control each function block in addition to a collection of USB libraries to enable a range of USB host or device solutions. All drivers will be provided as source code for easy adaptation and modification.

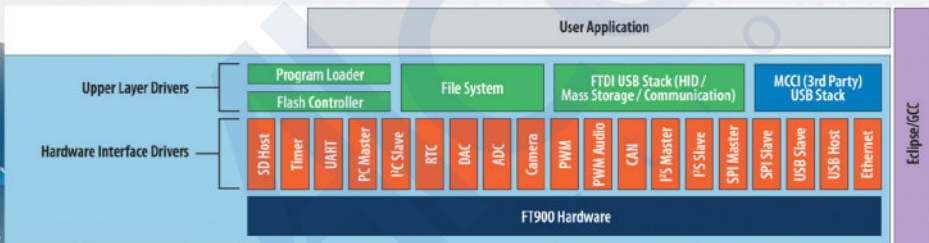

Firmware Download and Debug

With the plug-in developed by Bridgetek, the functionality of Eclipse is extended to support loading of compiled firmware into the target device via a dedicated 1-wire debug pin on the ICs. Running and debugging the firmware is also supported via the debugger pin with up to 3 breakpoints supported to assist debug. A dedicated debugger/programmer module is available to support these devices and interface with the Eclipse IDE.

3rd Party Tools

Bridgetek have been working closely with 3rd party partners in order to offer additional design aids. A collaboration with MCCI Corporation, a leading developer of USB drivers and firmware for embedded SoC has resulted in the availability of TrueTask USB, an embedded USB host stack designed for use with the FT90X MCU product family, and a partnership with MikroE has culminated to provide a comprehensive development environment for the FT90X including compilers, development boards, useful examples for click boards and Visual TFT software support. For more information on MCCI please visit www.mcci.com and visit www.mikroe.com for details on MirkoE.

FT90X Series Applications

FT90X series is a range of general purpose microcontrollers targetted at high performance systems and as application controllers that can be used in conjunction with EVE display controllers.

Target Applications include:

- Closed Circuit Monitoring
- Security Network Systems
- Traffic Congtrol
- Audio Players
- Access/Entry Systems
- Industrial Control and Monitoring
- Security Digital Video Recording
- Remote Cameras
- IoT Sensors
- Back-up Cameras
- IO Interface Bridges ... and many more

FT90X and EVE Based Video

The FT90X will accept video input from a CMOS camera sensor over the parallel camera interface or from a networked camera over Ethernet. Processing of the image can then be performed within the FT90X to create an FT800 compatible bit-map for output on a QVGA or QCIF display, with a target frame rate of up to 30fps (QCIF).



FT90X Based Audio

By making use of the SD CARD interface and the I2S interface to an external codec the FT90X may be used to implement a full feature MP3 player for streaming music and audio file playback.



FT90X Low Cost IP Camera

Easily interface video from a camera sensor via the FT900 to remote location via Ethernet connectivity.



CleO - The Smart TFT Display Arduino

CleO is simple to program, intelligent TFT display solution that allows the construction of human machine interfaces (HMIs) with much higher performance than conventional Arduino display shields are able to deliver. By using it, engineers of all different levels of aptitude (from seasoned professionals right through to keen amateurs) can develop next generation HMIs exhibiting elevated levels of functionality and superior graphical qualities.



HARDWARE

Adding full colour TFT display to a design is easy with CleO. Designed as an SPI shield for Arduino based MCUs the board delivers a 3.5" or 5" resistive touch display module with on board 8Mbyte eFlash for storing display and audio objects. Extra Hi-Speed peripherals such as a 5M pixel camera and SD card support is also included as is the option to add an 8ohm/1W speaker.

Key Features

- Anti-Aliased graphics throughout for much finer image quality with no "jaggies"
- Smooth animations at up to 60 frames/second
- Portrait and Landscape modes supported
- Inbuilt PWM Audio and speaker amplifier
- File system supports up to 8 simultaneous file operations
- Easy to use Resistive touch
- Fast direct file transfers between micro-SD/eFlash and the Graphics subsystem without using Arduino UNO resources
- Panel Mount Bezel Included

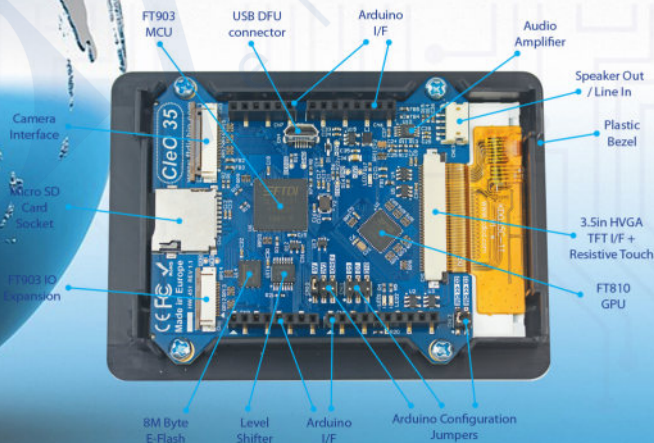

CleO Development Support

The CleO family of smart TFT display controllers can be easily programmed to give professional looking HMI / GUI's with no prior knowledge of complex graphics programming or mathematics.

With extensive tutorials (20 Chapters covering over 80 topics) + 21 DIY projects included to show you how, CleO35 (3.5" version) and CleO50 (5" version) allows both hobbyists and professionals alike to add a resistive touch TFT display GUI to their Arduino UNO projects.

CleO is designed to work onside NerO, our energy efficient enhanced Arduino Compatible board. This accessory delivers >1A current at 5V without overheating, and the long pin versions supplied allows CleO to be discretely mounted beneath NerO, leaving the shield headers fully exposed for IO expansion.

To access our full CleO support suite including tutorials, projects and examples and an interactive forum, please visit www.CleOstuff.com

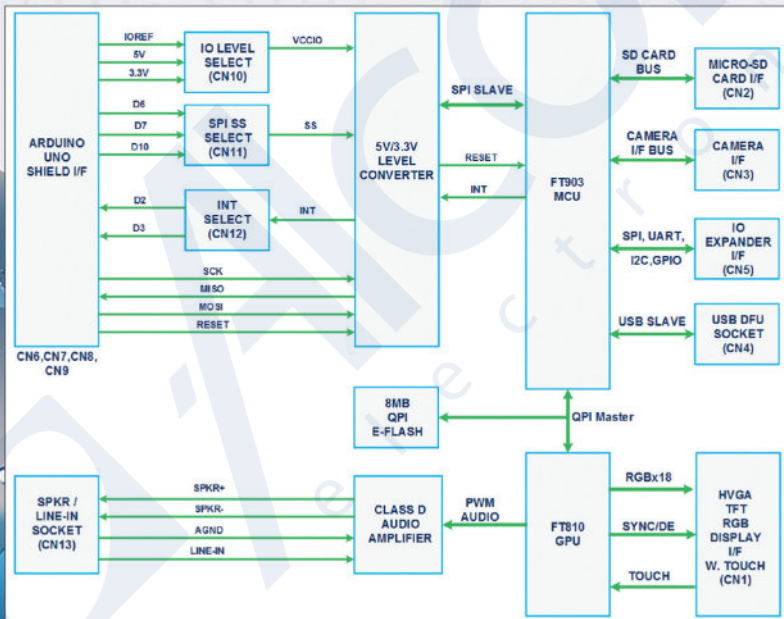

About Us

Bridgetek is a leading global semi-conductor company providing high performance microcontroller units (MCUs), display IC products and developing innovative silicon solutions that enhance seamless interaction with latest connectivity technologies.

The key objective from the company is to provide core bridging technology in order to support engineers with highly sophisticated, feature-rich, robust and simple-to-use product platforms. These platforms enable creation of electronic designs with high performance, low peripheral component requirements, low power budgets and minimal board real estate.

Bridgetek resources will be devoted to two particular product areas; the multi-award winning Embedded Video Engine (EVE) graphic controller ICs which enable engineers to implement more sophisticated human machine interface (HMI) systems, plus the unique and equally innovative performance-optimised microcontroller units (MCUs) with their expansive array of different connectivity options and industry-leading processing speeds.



Singapore (HQ)
1 Tai Seng Avenue,
Tower A, #03-05,
Singapore 536464

Taiwan

2F No. 516 Sec 1, NeiHu
Road Taipei 114, Taiwan
Tel : +886 (2) 8797 1330
Fax: +886 (2) 8751 9737

USA

7130 SW Fir Loop Tigard,
OR, 97223-8160 USA
Tel : +1 (503) 547 0988
Fax: +1 (503) 547 0987

UK

Unit 1, 2 Seaward Place
Centurion Business Park
Glasgow, G41 1HH, UK
Tel : +44 (0) 141 429 2777
Fax: +44 (0) 141 429 2758

Vietnam

5F Lutaco Tower Building, 173A
Nguyen Van Troi, Ward 11, Phu
Nhuan District, Ho Chi Minh City
Tel : +84 (08) 3845 3222
Fax: +84 (08) 3845 5222

