

# Bridgelux<sup>®</sup> GENg V18 Array Series

Product Data Sheet DS1309



# Introduction

V Series



The V Series™ LED Array products deliver high quality light in a compact and cost-effective solid-state lighting package. These chip on board (CoB) arrays can be efficiently driven more than two times the nominal drive current, enabling design flexibility not previously possible. These high flux density light sources are designed to support a wide range of high quality, low cost directional luminaires and replacement lamps for both interior and exterior commercial and residential applications.

The Gen 9 V Series COB is a high efficacy product that uses narrow band red phosphor to significantly improve the spectrum efficacy. The improved spectrum efficacy results in the 80 CRI product of the Gen 9 Series delivering better or equivalent efficacy as that of our previous generation V Series product.

The V18 LED Array is available in a variety of electrical, CCT, and CRI combinations providing substantial design flexibility and energy efficiency advantages.

Lighting system designs incorporating these LED arrays deliver increased system level efficacy and a longer service life. Typical applications include replacement lamps and task, accent, spot, track, wide area, security, wall packs and down lights.

## Features

- Efficacy of 200 lm/W typical, 3000K 80 CRI
- Wide selection of CCT options (2700K-5000K) with minimum 80 CRI options
- Uniform high-quality illumination
- 2 and 3 SDCM binning options (2700K – 4000K)
- 3 and 4 SDCM binning options (5000K)
- Forward voltage bin codes and backside marking
- Instant light with unlimited dimming
- 5-Year warranty

## Benefits

- Enables high efficiency lighting systems and lower operating costs
- Supports the trend toward luminaire miniaturization and delivers enhanced optical control
- Design flexibility for a broad range of lighting applications
- Clean white light without pixelation
- Uniform consistent white light
- Design flexibility for multi-source applications
- Easy to use with daylight and motion sensors to increase energy savings
- Design with confidence



# Contents

Product Feature Map	2
Product Nomenclature	2
Product Selection Guide	3
European Product Registry for Energy Labeling	5
Performance at Commonly Used Drive Currents	6
Electrical Characteristics	8
Eye Safety	9
Absolute Maximum Ratings	10
Performance Curves	11
Typical Radiation Pattern	13
Typical Color Spectrum	14
Mechanical Dimensions	15
Color Binning Information	16
Packaging and Labeling	17
Design Resources	19
Precautions	19
Disclaimers	19
About Bridgelux	20



# Product Selection Guide

The following product configurations are available:

**Table 1:** Selection Guide, Pulsed Measurement Data ( $T_j = T_c = 25^\circ\text{C}$ )

Part Number	Nominal CCT <sup>1</sup> (K)	CRI <sup>2</sup>	Nominal Drive Current <sup>3</sup> (mA)	Typical Pulsed Flux <sup>4,5,6</sup> $T_c = 25^\circ\text{C}$ (lm)	Minimum Pulsed Flux <sup>6,7</sup> $T_c = 25^\circ\text{C}$ (lm)	Typical $V_f$ (V)	Typical Power (W)	Typical Efficacy (lm/W)
BXRE-27E40F0-B-gx	2700	80	700	4626	4163	34.0	23.8	194
BXRE-27E40F0-C-gx	2700	80	900	5966	5370	33.9	30.5	196
BXRE-30E40F0-B-gx	3000	80	700	4720	4248	34.0	23.8	198
BXRE-30E40F0-C-gx	3000	80	900	6088	5479	33.9	30.5	200
BXRE-35E40F0-B-gx	3500	80	700	4744	4269	34.0	23.8	199
BXRE-35E40F0-C-gx	3500	80	900	6118	5507	33.9	30.5	201
BXRE-40E40F0-B-gx	4000	80	700	4767	4290	34.0	23.8	200
BXRE-40E40F0-C-gx	4000	80	900	6149	5534	33.9	30.5	202
BXRE-50E40F0-B-gx	5000	80	700	4673	4206	34.0	23.8	196
BXRE-50E40F0-C-gx	5000	80	900	6027	5424	33.9	30.5	198

Notes for Table 1:

- Nominal CCT as defined by ANSI C78.377-2011.
- CRI values are minimums and tested at  $T_j = T_c = 85^\circ\text{C}$ . Minimum Rg value for 80 CRI products is 0. Bridgelux maintains a  $\pm 3$  tolerance on CRI and Rg values.
- Drive current is referred to as nominal drive current.
- Products tested under pulsed condition (10ms pulse width) at nominal drive current where  $T_j$  (junction temperature) -  $T_c$  (case temperature) =  $25^\circ\text{C}$ .
- Typical performance values are provided as a reference only and are not a guarantee of performance.
- Bridgelux maintains a  $\pm 7\%$  tolerance on flux measurements.
- Minimum flux values at the nominal drive current are guaranteed by 100% test.

# Product Selection Guide

**Table 2:** Selection Guide, Stabilized DC Performance ( $T_c = 85^\circ\text{C}$ )<sup>4,5</sup>

Part Number	Nominal CCT <sup>1</sup> (K)	CRI <sup>2</sup>	Nominal Drive Current <sup>3</sup> (mA)	Typical DC Flux <sup>4,5</sup> $T_c = 85^\circ\text{C}$ (lm)	Minimum DC Flux <sup>6</sup> $T_c = 85^\circ\text{C}$ (lm)	Typical $V_f$ (V)	Typical Power (W)	Typical Efficacy (lm/W)
BXRE-27E40F0-B-gx	2700	80	700	4256	3830	33.4	23.4	182
BXRE-27E40F0-C-gx	2700	80	900	5489	4940	33.3	30.0	183
BXRE-30E40F0-B-gx	3000	80	700	4342	3908	33.4	23.4	186
BXRE-30E40F0-C-gx	3000	80	900	5601	5041	33.3	30.0	187
BXRE-35E40F0-B-gx	3500	80	700	4364	3928	33.4	23.4	187
BXRE-35E40F0-C-gx	3500	80	900	5629	5066	33.3	30.0	188
BXRE-40E40F0-B-gx	4000	80	700	4386	3947	33.4	23.4	188
BXRE-40E40F0-C-gx	4000	80	900	5657	5091	33.3	30.0	189
BXRE-50E40F0-B-gx	5000	80	700	4299	3869	33.4	23.4	184
BXRE-50E40F0-C-gx	5000	80	900	5545	4990	33.3	30.0	185

Notes for Table 2:

- Nominal CCT as defined by ANSI C78.377-2011.
- CRI values are minimums and tested at  $T_j - T_c = 85^\circ\text{C}$ . Minimum Rg value for 80 CRI products is 0, Bridgelux maintains a  $\pm 3$  tolerance on CRI and Rg values.
- Drive current is referred to as nominal drive current.
- Typical stabilized DC performance values are provided as reference only and are not a guarantee of performance.
- Typical performance is estimated based on operation under DC (direct current) with LED array mounted onto a heat sink with thermal interface material and the case temperature maintained at  $85^\circ\text{C}$ . Based on Bridgelux test setup, values may vary depending on the thermal design of the luminaire and/or the exposed environment to which the product is subjected.
- Minimum flux values at elevated temperatures are provided for reference only and are not guaranteed by 100% production testing. Based on Bridgelux test setup, values may vary depending on the thermal design of the luminaire and/or the exposed environment to which the product is subjected.



# Performance at Commonly Used Drive Currents

V Series LED arrays are tested to the specifications shown using the nominal drive currents in Table 1. V Series may also be driven at other drive currents dependent on specific application design requirements. The performance at any drive current can be derived from the current vs. voltage characteristics shown in Figures 1 & 2 and the flux vs. current characteristics shown in Figures 3 & 4. The performance at commonly used drive currents is summarized in Table 4.

**Table 4:** Product Performance at Commonly Used Drive Currents

Part Number	CRI	Drive Current <sup>1</sup> (mA)	Typical $V_f$ $T_c = 25^\circ\text{C}$ (V)	Typical Power $T_c = 25^\circ\text{C}$ (W)	Typical Flux <sup>2</sup> $T_c = 25^\circ\text{C}$ (lm)	Typical DC Flux <sup>3</sup> $T_c = 85^\circ\text{C}$ (lm)	Typical Efficacy $T_c = 25^\circ\text{C}$ (lm/W)
BXRE-27E40Fo-B-gx	80	100	31.0	3.1	667	619	215
		200	31.6	6.3	1363	1272	216
		240	31.8	7.6	1637	1528	214
		<b>700</b>	<b>34.0</b>	<b>23.8</b>	<b>4626</b>	<b>4256</b>	<b>194</b>
		1200	35.9	43.1	7620	6882	177
		1620	37.5	60.8	10023	8927	165
BXRE-27E40Fo-C-gx	80	300	31.7	9.5	2049	1910	215
		600	32.9	19.7	4052	3758	205
		720	33.3	24.0	4828	4463	201
		<b>900</b>	<b>33.9</b>	<b>30.5</b>	<b>5966</b>	<b>5489</b>	<b>196</b>
		1620	35.9	58.2	10287	9278	177
		2160	37.5	81.0	13378	11904	165
BXRE-30E40Fo-B-gx	80	100	31.0	3.1	681	632	220
		200	31.6	6.3	1391	1298	220
		240	31.8	7.6	1671	1559	219
		<b>700</b>	<b>34.0</b>	<b>23.8</b>	<b>4720</b>	<b>4342</b>	<b>198</b>
		1200	35.9	43.1	7776	7023	181
		1620	37.5	60.8	10227	9109	168
BXRE-30E40Fo-C-gx	80	300	31.7	9.5	2090	1949	219
		600	32.9	19.7	4135	3835	209
		720	33.3	24.0	4926	4555	205
		<b>900</b>	<b>33.9</b>	<b>30.5</b>	<b>6088</b>	<b>5601</b>	<b>200</b>
		1620	35.9	58.2	10497	9467	180
		2160	37.5	81.0	13651	12147	168
BXRE-35E40Fo-B-gx	80	100	31.0	3.1	684	635	221
		200	31.6	6.3	1398	1305	221
		240	31.8	7.6	1679	1567	220
		<b>700</b>	<b>34.0</b>	<b>23.8</b>	<b>4744</b>	<b>4364</b>	<b>199</b>
		1200	35.9	43.1	7815	7058	181
		1620	37.5	60.8	10278	9155	169
BXRE-35E40Fo-C-gx	80	300	31.7	9.5	2101	1959	221
		600	32.9	19.7	4156	3854	210
		720	33.3	24.0	4951	4577	206
		<b>900</b>	<b>33.9</b>	<b>30.5</b>	<b>6118</b>	<b>5629</b>	<b>201</b>
		1620	35.9	58.2	10550	9514	181
		2160	37.5	81.0	13719	12208	169

Notes for Table 4:

1. Alternate drive currents in Table 4 are provided for reference only and are not a guarantee of performance.
2. Bridgelux maintains a  $\pm 7\%$  tolerance on flux measurements.
3. Typical stabilized DC performance values are provided as reference only and are not a guarantee of performance.



# Performance at Commonly Used Drive Currents

**Table 4:** Product Performance at Commonly Used Drive Currents (Continued)

Part Number	CRI	Drive Current <sup>1</sup> (mA)	Typical $V_f$ $T_c = 25^\circ\text{C}$ (V)	Typical Power $T_c = 25^\circ\text{C}$ (W)	Typical Flux <sup>2</sup> $T_c = 25^\circ\text{C}$ (lm)	Typical DC Flux <sup>3</sup> $T_c = 85^\circ\text{C}$ (lm)	Typical Efficacy $T_c = 25^\circ\text{C}$ (lm/W)
BXRE-40E40F0-B-gx	80	100	31.0	3.1	688	638	222
		200	31.6	6.3	1405	1311	222
		240	31.8	7.6	1687	1575	221
		<b>700</b>	<b>34.0</b>	<b>23.8</b>	<b>4767</b>	<b>4386</b>	<b>200</b>
		1200	35.9	43.1	7854	7093	182
		1620	37.5	60.8	10329	9200	170
BXRE-40E40F0-C-gx	80	300	31.7	9.5	2111	1969	222
		600	32.9	19.7	4176	3873	212
		720	33.3	24.0	4975	4600	207
		<b>900</b>	<b>33.9</b>	<b>30.5</b>	<b>6149</b>	<b>5657</b>	<b>202</b>
		1620	35.9	58.2	10602	9562	182
		2160	37.5	81.0	13787	12269	170
BXRE-50E40F0-B-gx	80	100	31.0	3.1	674	626	217
		200	31.6	6.3	1377	1285	218
		240	31.8	7.6	1654	1543	217
		<b>700</b>	<b>34.0</b>	<b>23.8</b>	<b>4673</b>	<b>4299</b>	<b>196</b>
		1200	35.9	43.1	7698	6953	179
		1620	37.5	60.8	10125	9018	167
BXRE-50E40F0-C-gx	80	300	31.7	9.5	2069	1930	217
		600	32.9	19.7	4094	3796	207
		720	33.3	24.0	4877	4509	203
		<b>900</b>	<b>33.9</b>	<b>30.5</b>	<b>6027</b>	<b>5545</b>	<b>198</b>
		1620	35.9	58.2	10392	9372	178
		2160	37.5	81.0	13514	12026	167

Notes for Table 4:

1. Alternate drive currents in Table 4 are provided for reference only and are not a guarantee of performance.
2. Bridgelux maintains a  $\pm 7\%$  tolerance on flux measurements.
3. Typical stabilized DC performance values are provided as reference only and are not a guarantee of performance.

# Electrical Characteristics

**Table 5:** Electrical Characteristics

Part Number	Drive Current (mA)	Forward Voltage Pulsed, $T_c = 25^\circ\text{C}$ (V) <sup>1, 2, 3, 8</sup>			Typical Coefficient of Forward Voltage <sup>4</sup> $\Delta V_f / \Delta T_c$ (mV/ $^\circ\text{C}$ )	Typical Thermal Resistance Junction to Case <sup>5,6</sup> $R_{j-c}$ ( $^\circ\text{C}/\text{W}$ )	Driver Selection Voltages <sup>7</sup> (V)	
		Minimum	Typical	Maximum			$V_f$ Min. Hot $T_c = 95^\circ\text{C}$ (V)	$V_f$ Max. Cold $T_c = -40^\circ\text{C}$ (V)
BXRE-xxx40Fx-B-gx	700	32.0	34.0	36.0	-13.36	0.14	31.2	37.3
	1620	35.3	37.5	39.8	-14.79	0.23	34.4	41.2
BXRE-xxx40Fx-C-gx	900	31.9	33.9	35.9	-13.32	0.11	31.1	37.2
	2160	35.3	37.5	39.8	-14.74	0.20	34.4	41.2

Notes for Table 5:

- Parts are tested in pulsed conditions,  $T_c = 25^\circ\text{C}$ . Pulse width is 10ms.
- Voltage minimum and maximum are provided for reference only and are not a guarantee of performance.
- Bridgelux maintains a tester tolerance of  $\pm 0.10\text{V}$  on forward voltage measurements.
- Typical coefficient of forward voltage tolerance is  $\pm 0.1\text{mV}$  for nominal current.
- Thermal resistance values are based from test data of a 3000K 80 CRI product.
- Thermal resistance value was calculated using total electrical input power; optical power was not subtracted from input power. The thermal interface material used during testing is not included in the thermal resistance value.
- $V_f$  min hot and max cold values are provided as reference only and are not guaranteed by test. These values are provided to aid in driver design and selection over the operating range of the product.
- This product has been designed and manufactured per IEC 62031:2018.

# Eye Safety

**Table 6:** Eye Safety Risk Group (RG) Classifications

Part Number	Drive Current (mA)	CCT <sup>4</sup>	
		2700K/3000K	3500-5000K <sup>2,3</sup>
BXRE-xxx40Fx-B-gx		RG1	RG1
		RG1	RG2
BXRE-xxx40Fx-C-gx		RG1	RG1
		RG1	RG2

Notes for Table 6:

1. Eye safety classification for the use of Bridgelux V Series LED arrays is in accordance with specification IEC/TR 62778: Application of IEC 62471 for the assessment of blue light hazard to light sources and luminaires.
2. For products classified as RG2 at 4000K, Ethr= 1980 lx.
3. For products classified as RG2 at 5000K Ethr= 1530 lx.
4. Please contact your Bridgelux sales representative for Ethr values at specific drive currents and CCTs not listed.

# Absolute Maximum Ratings

**Table 7:** Maximum Ratings

Parameter	Maximum Rating	
LED Junction Temperature ( $T_j$ )	150°C	
Storage Temperature <sup>1</sup>	-40°C to +95°C	
Operating Case Temperature <sup>2</sup> ( $T_c$ )	95°C	
Soldering Temperature <sup>3</sup>	300°C or lower for a maximum of 6 seconds	
	BXRE-xxx40Fx-B-gx	BXRE-xxx40Fx-C-gx
Maximum Drive Current <sup>4</sup>	1620 mA at ≤85°C 1215 mA at 95°C	2160 mA at ≤85°C 1620 mA at 95°C
Maximum Peak Pulsed Drive Current <sup>5</sup>	2320mA	3090 mA
Maximum Reverse Voltage <sup>6</sup>	-60V	-60V

Notes for Table 7:

1. The Gen 9 product is robust enough to pass our internal humidity test but it is still more sensitive compared to regular LED array product. The product needs to be stored in a dry environment. It is not recommended to use the product in a damp environment that directly exposes it to moisture.
2. For IEC 62717 requirement, please consult your Bridgelux sales representative.
3. Refer to Bridgelux Application Note AN101: Handling and Assembly of Bridgelux V Series LED Arrays
4. Arrays may be driven at higher currents however lumen maintenance may be reduced and warranty will not apply.
5. Bridgelux recommends a maximum duty cycle of 10% and pulse width of 20 ms when operating LED Arrays at maximum peak pulsed current specified. Maximum peak pulsed currents indicate values where LED Arrays can be driven without catastrophic failures.
6. Light emitting diodes are not designed to be driven in reverse voltage and will not produce light under this condition. Maximum rating provided for reference only.

# Performance Curves

**Figure 1: V18B Drive Current vs. Voltage**

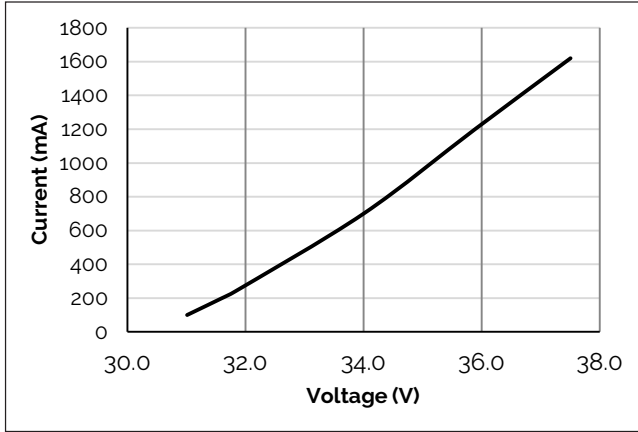

**Figure 2: V18C Drive Current vs. Voltage**

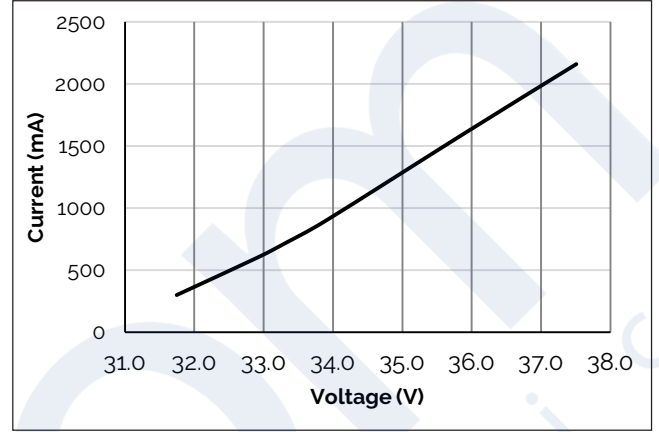

**Figure 3: V18B Typical Relative Flux vs. Current**

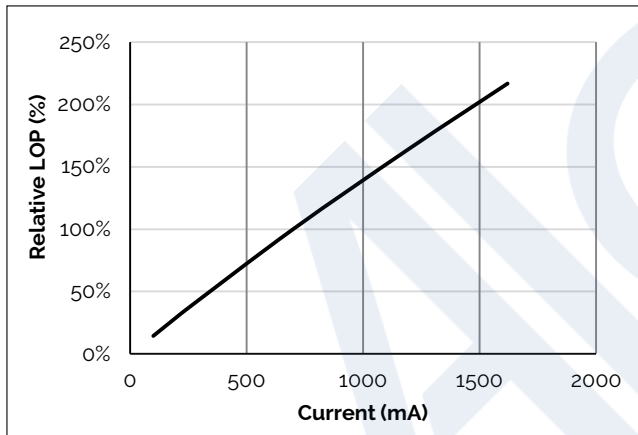

**Figure 4: V18C Typical Relative Flux vs. Current**

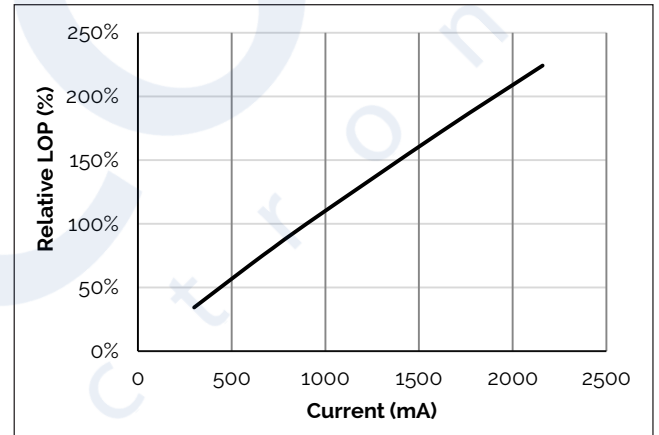

**Figure 5: Typical DC Flux vs. Case Temperature**

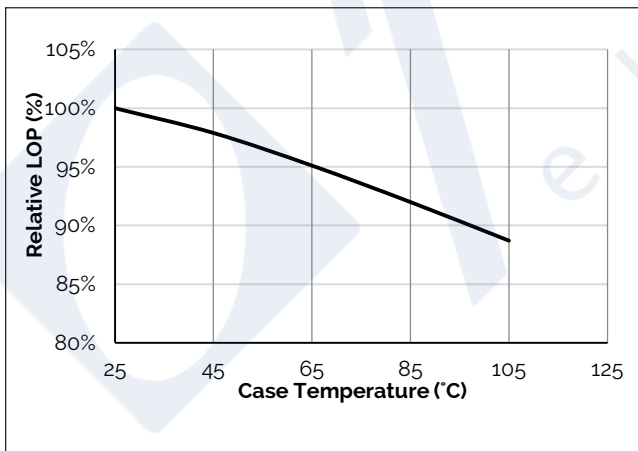

**Figure 6: Typical DC cxx Shift vs. Case Temperature**

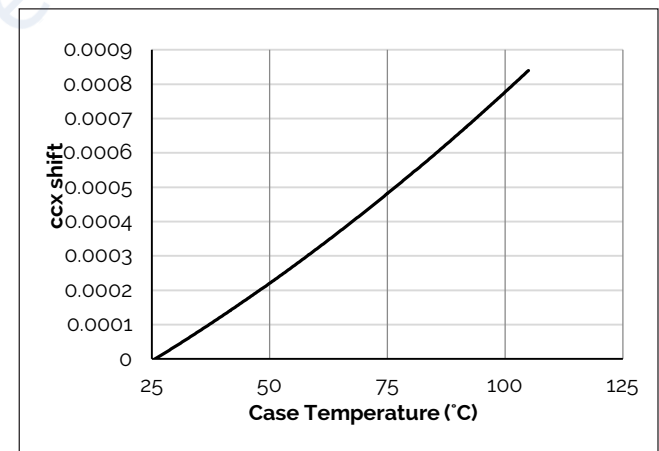

Notes for Figures 1-4:

1. Bridgelux does not recommend driving high power LEDs at low currents. Doing so may produce unpredictable results. Pulse width modulation (PWM) is recommended for dimming effects.
2. Products tested under pulsed condition (10ms pulse width) at nominal drive current where  $T_j$  (junction temperature) =  $T_c$  (case temperature) = 25°C.

Note for Figures 5-6:

1. Characteristics shown for Warm White.

# Performance Curves

Figure 7: Typical DC ccy Shift vs. Case Temperature

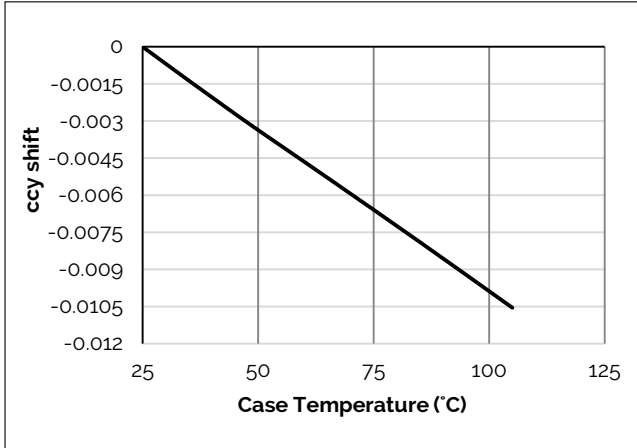

Figure 8: V18B Drive Current vs. ccx Shift

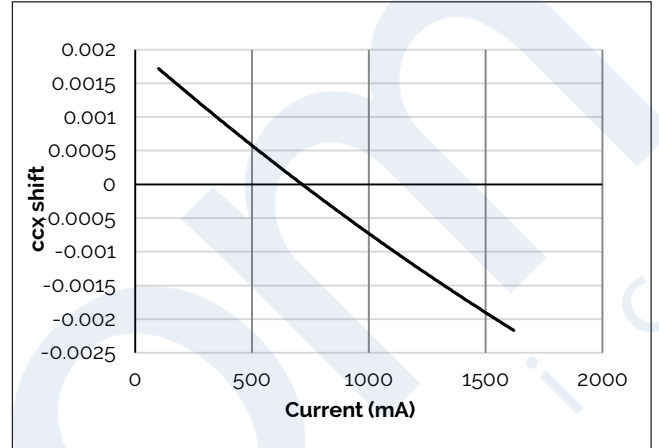

Figure 9: V18B Drive Current vs. ccy Shift

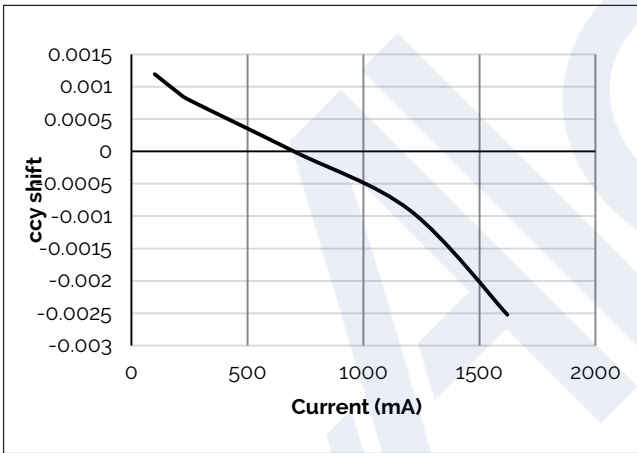

Figure 10: V18C Drive Current vs. ccx Shift

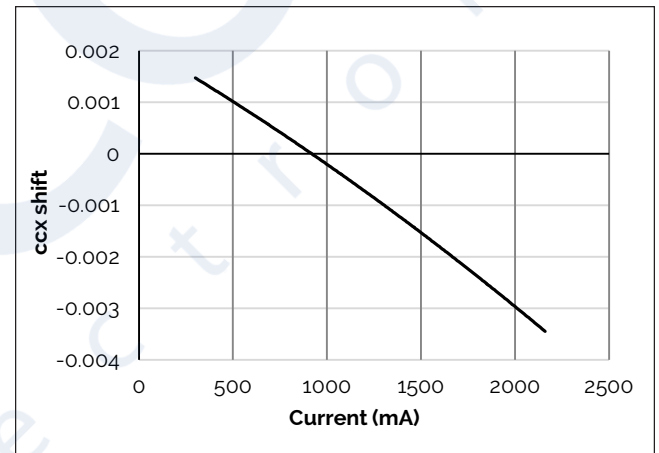

Figure 11: V18

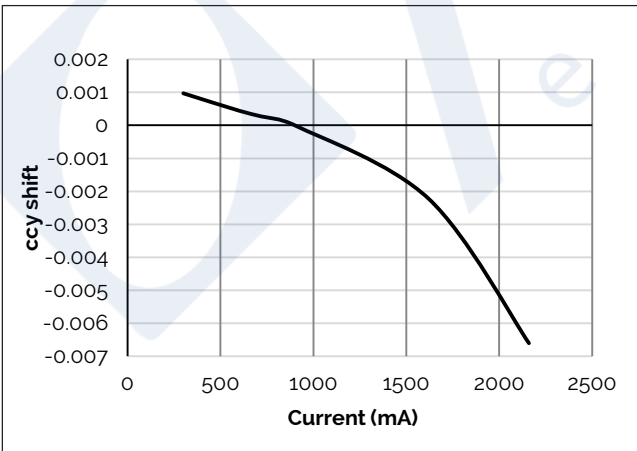
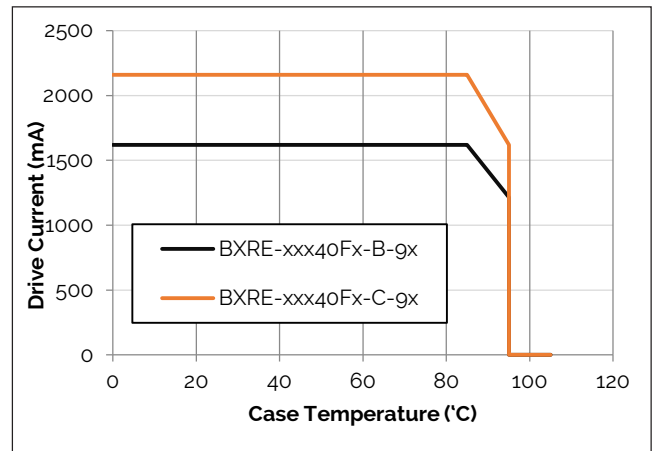

Figure 12: Derating Curve



Note for Figures 7-11:  
1. Characteristics shown for Warm White.

# Typical Radiation Pattern

Figure 13: Typical Spatial Radiation Pattern

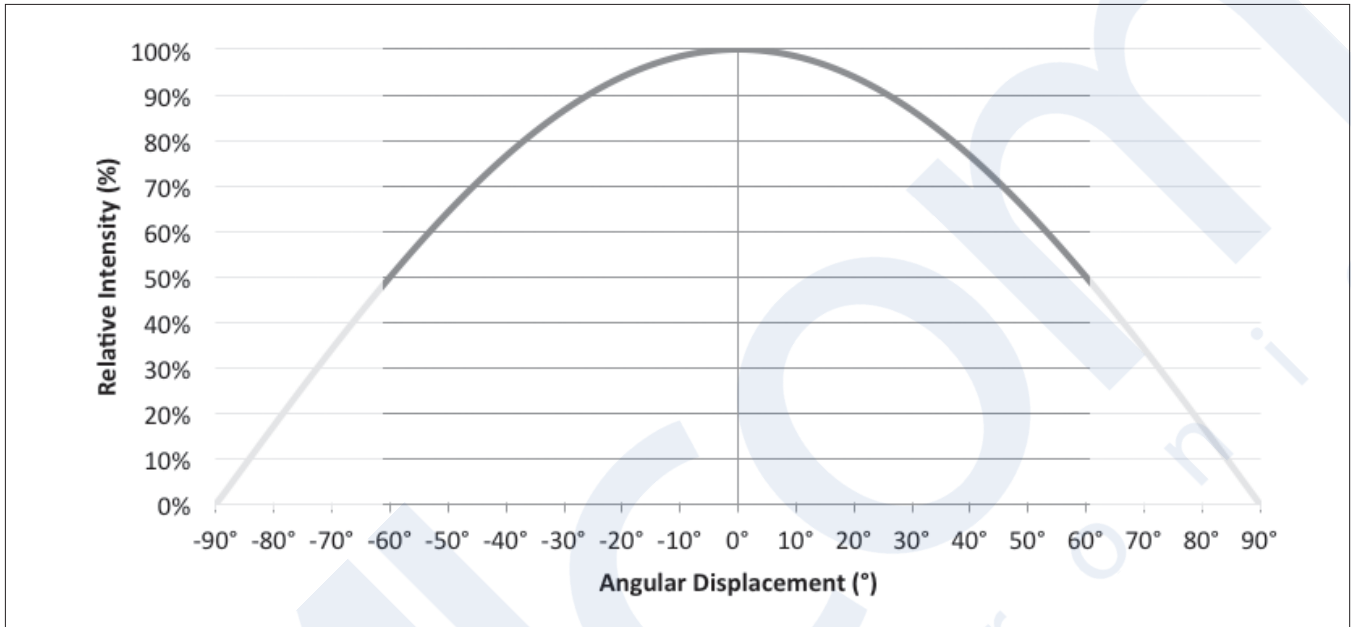

Notes for Figure 13:

1. Typical viewing angle is 120°.
2. The viewing angle is defined as the off axis angle from the centerline where intensity is ½ of the peak value.

Figure 14: Typical Polar Radiation Pattern

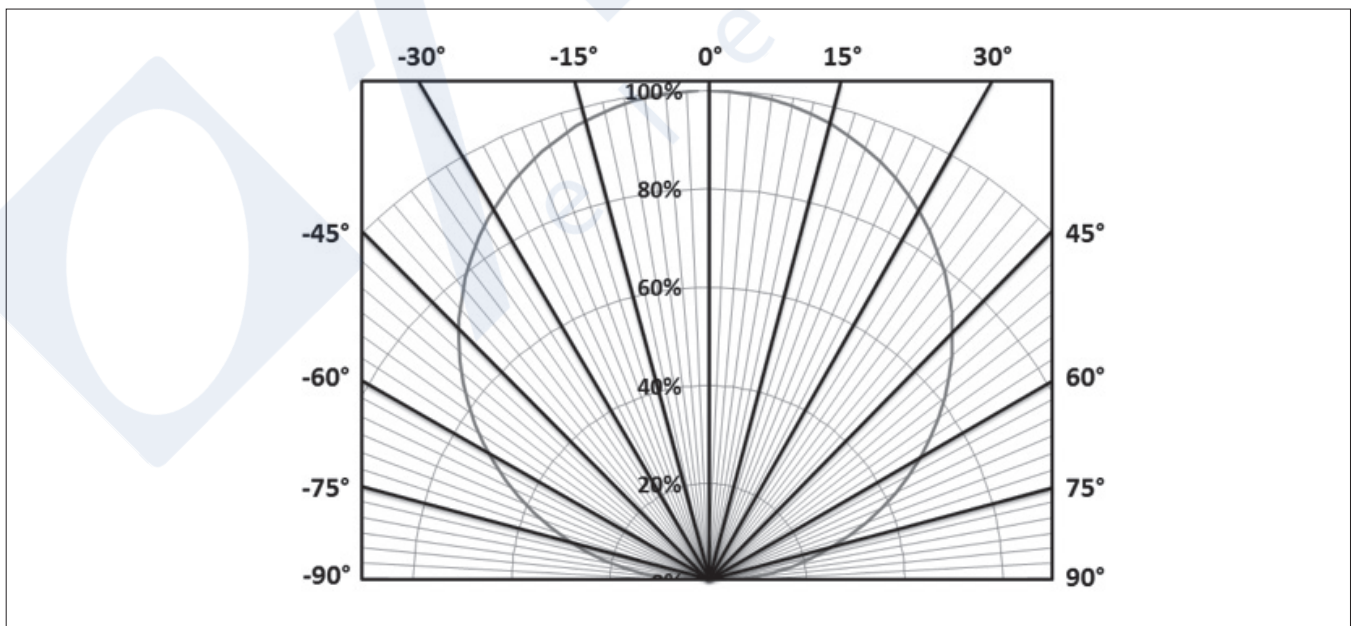

# Typical Color Spectrum

Figure 15: Typical Color Spectrum

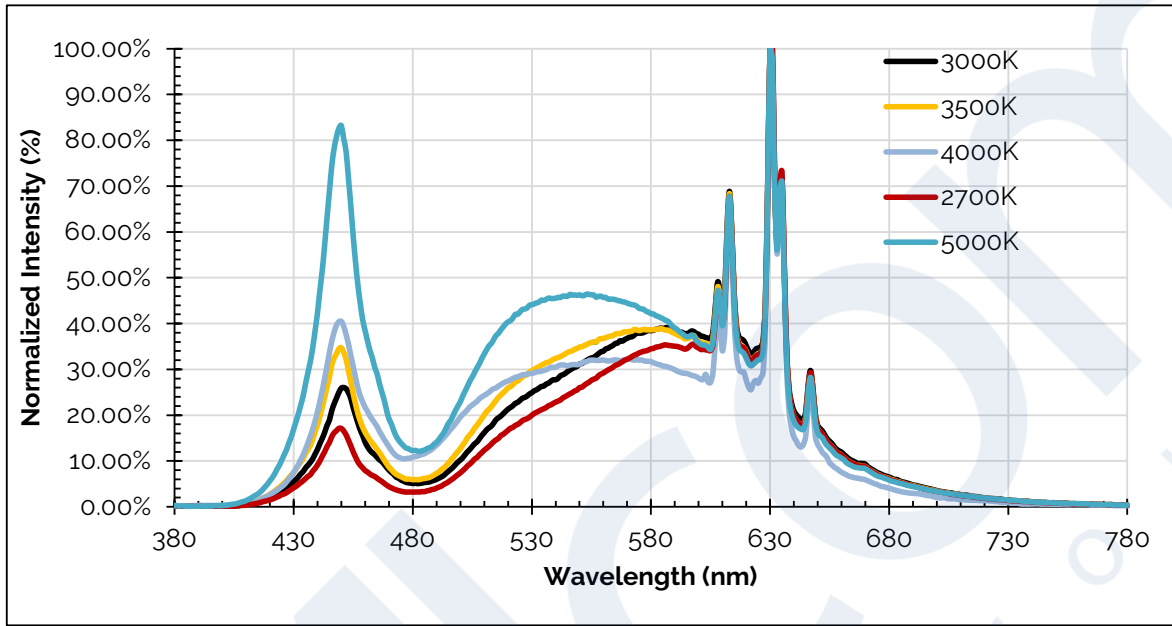

Notes for Figure 15:

1. Color spectra measured at nominal current for  $T_j - T_c = 85^\circ\text{C}$ .
2. Color spectra shown is 2700K and 80CRI.
3. Color spectra shown is 3000K and 80 CRI.
4. Color spectra shown is 3500K and 80 CRI.
5. Color spectra shown is 4000K and 80 CRI.
6. Color spectra shown is 5000K and 80 CRI.



# Mechanical Dimensions

Figure 16: Drawing for V18 LED Array

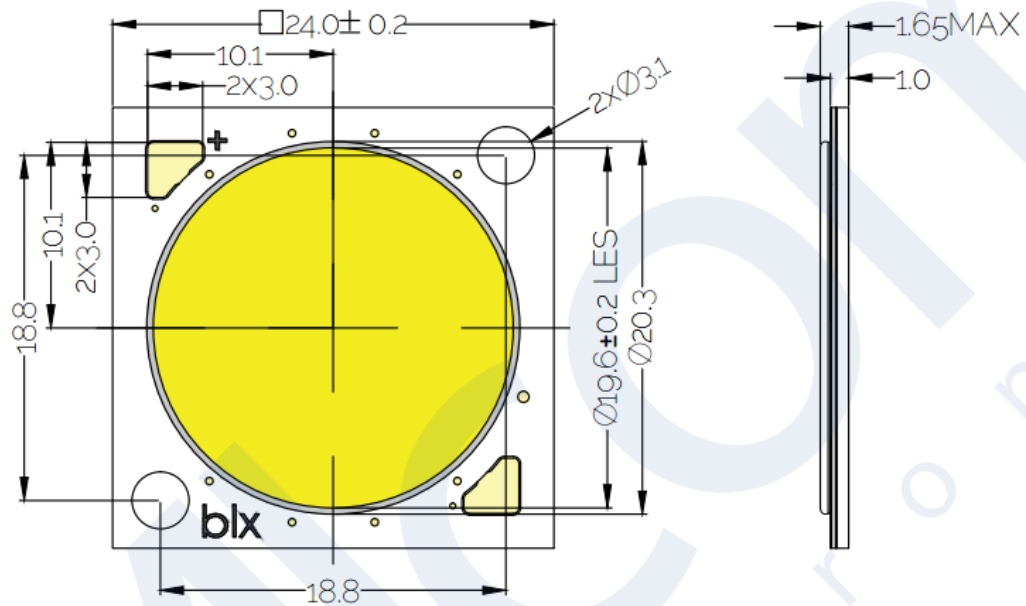

Notes for Figure 16:

1. Drawings are not to scale.
2. Drawing dimensions are in millimeters.
3. Solder pads are labeled "+" and "-" to denote positive and negative polarity, respectively.
4. Unless otherwise specified, tolerances are  $\pm 0.1$ mm.
5. Refer to Application Notes AN101 for product handling, mounting and heat sink recommendations.
6. The optical center of the LED Array is nominally defined by the mechanical center of the array to a tolerance of  $\pm 0.2$ mm.
7. Bridgelux maintains a flatness of  $0.10$ mm across the mounting surface of the array.

# Color Binning Information

**Figure 17: Warm, Neutral and Cool White Test Bins in xy Color Space**

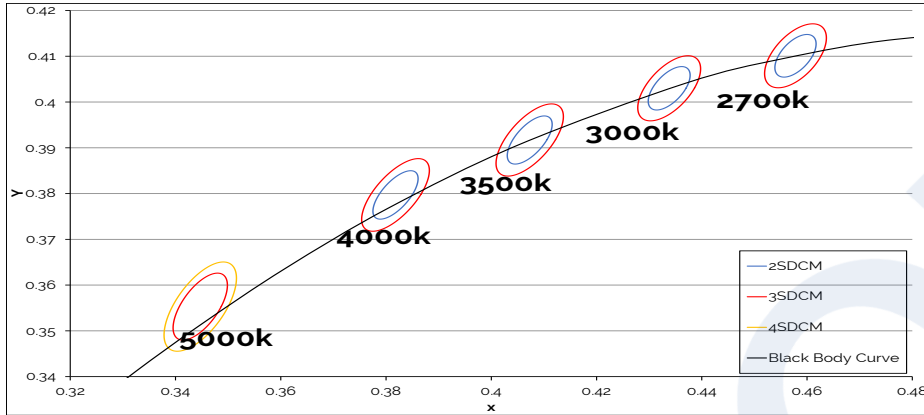

Note: Pulsed Test Conditions,  $T_c = 85^\circ\text{C}$

**Table 8:** Warm and Neutral White xy Bin Coordinates and Associated Typical CCT (product is hot targeted to  $T_c = 85^\circ\text{C}$ )

Bin Code	2700K	3000K	3500K	4000K
ANSI Bin (for reference only)	(2580K - 2870K)	(2870K - 3220K)	(3220K - 3710K)	(3710K - 4260K)
g3 (3 SDCM)	(2651K - 2794K)	(2968K - 3136K)	(3369K - 3586K)	(3851K - 4130K)
g2 (2 SDCM)	(2674K - 2769K)	(2995K - 3107K)	(3404K - 3548K)	(3895K - 4081K)
Center Point (x,y)	(0.4578, 0.4101)	(0.4338, 0.403)	(0.4073, 0.3917)	(0.3818, 0.3797)

**Table 9:** Cool White xy Bin Coordinates and Associated Typical CCT (product is hot targeted to  $T_c = 85^\circ\text{C}$ )

Bin Code	5000K
ANSI Bin (for reference only)	(4745K - 5311K)
g4 (4 SDCM)	(4801K - 5282K)
g3 (3 SDCM)	(4835K - 5215K)
Center Point (x,y)	(0.3447, 0.3553)

Note for Tables 8-g:

1. Bridgelux maintains a tolerance of +/- 0.007 on x and y color coordinates in the CIE 1931 color Space.

# Packaging and Labeling

Figure 18: V18 Packaging Tubes



Notes for Figure 18:

1. Each tube holds 20 V18 COB arrays.
2. One tube is sealed in an anti-static bag. Four bags are placed in a shipping box. Depending on quantities ordered, a bigger shipping box, containing four boxes may be used to ship products.
3. Each bag and box is to be labeled as shown above.
4. Dimensions for each tube are 21.3 (W) x 9.5(H) x 505 (L). Dimensions for the anti-static bag are 75 (W) x 615 (L) x 3.1 (T) mm. Dimensions for the shipping box are 58.7 x 13.3 x 7.9 cm.

# Packaging and Labeling

**Figure 19: Gen. 9 Product Labeling**

Bridgelux COB arrays have laser markings on the back side of the substrate to help with product identification. In addition to the product identification markings, Bridgelux COB arrays also contain markings for internal Bridgelux manufacturing use only. The image below shows which markings are for customer use and which ones are for Bridgelux internal use only. The Bridgelux internal manufacturing markings are subject to change without notice, however these will not impact the form, function or performance of the COB array.



# Design Resources

## Application Notes

Bridgelux has developed a comprehensive set of application notes and design resources to assist customers in successfully designing with the V Series product family of LED array products. For all available application notes visit [www.bridgelux.com](http://www.bridgelux.com).

## Optical Source Models

Optical source models and ray set files are available for all Bridgelux products. For a list of available formats, visit [www.bridgelux.com](http://www.bridgelux.com).

## 3D CAD Models

Three dimensional CAD models depicting the product outline of all Bridgelux V Series LED arrays are available in both IGS and STEP formats. Please contact your Bridgelux sales representative for assistance.

## LM80

LM80 testing has been completed and the LM80 report is now available. Please contact your Bridgelux sales representative for LM-80 report.

# Precautions

## CAUTION: CHEMICAL EXPOSURE HAZARD

Exposure to some chemicals commonly used in luminaire manufacturing and assembly can cause damage to the LED array. Please consult Bridgelux Application Note AN101 for additional information.

## CAUTION: RISK OF BURN

Do not touch the V Series LED array during operation. Allow the array to cool for a sufficient period of time before handling. The V Series LED array may reach elevated temperatures such that could burn skin when touched.

## CAUTION

### CONTACT WITH LIGHT EMITTING SURFACE (LES)

Avoid any contact with the LES. Do not touch the LES of the LED array or apply stress to the LES (yellow phosphor resin area). Contact may cause damage to the LED array.

Optics and reflectors must not be mounted in contact with the LES (yellow phosphor resin area).

# Disclaimers

## MINOR PRODUCT CHANGE POLICY

The rigorous qualification testing on products offered by Bridgelux provides performance assurance. Slight cosmetic changes that do not affect form, fit, or function may occur as Bridgelux continues product optimization.

## STANDARD TEST CONDITIONS

Unless otherwise stated, array testing is performed at the nominal drive current.