

084S/084SM

SNAP-IN SINGLE STAGE FILTERED POWER ENTRY MODULE (GENERAL PURPOSE & MEDICAL) WITH DUAL FUSE AND SWITCH

FEATURES

- » Rated currents include **1A, 3A, 6A, 10A and 15A**
- » IEC Inlet with Double Fuse Holder
- » DPST Switch
- » Single Stage
- » General Purpose & Low Leakage (M)edical options
- » Agency Approvals *UL and EN 60939, CSA C22.2 (in testing)*
- » Y-cap value can be adjusted

ELECTRICAL SCHEMATIC

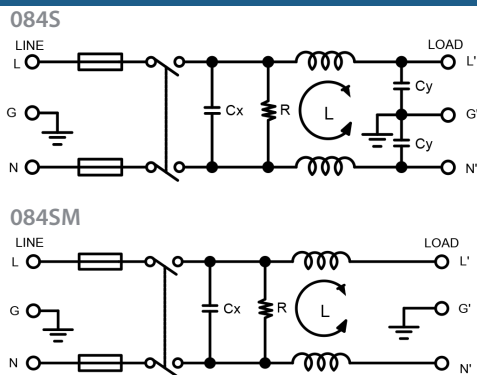

HOW TO ORDER

084SM.0ZZ00.00



NOTE: USE ANY COMBINATION OF **M** AND **ZZ**

E.G. **084S.00100.00** (1A GENERAL PURPOSE VERSION) | **084SM.00300.00** (3A LOW LEAKAGE MEDICAL VERSION)

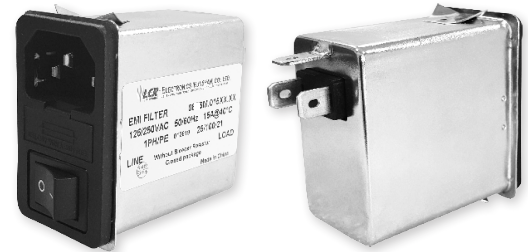

SPECIFICATIONS

OPERATING FREQUENCY	50/60HZ
IEC INLET	C14
MAX. OPERATING VOLTAGE	250VAC +10%
AMBIENT TEMPERATURE	-25 TO 40°C
CLIMATIC CATEGORY	25/100/21
TERMINALS	0.25" TABS

TYP. WEIGHT, LBS (KG) 0.20 (0.09)

TYPICAL LEAKAGE CURRENT 084S

@ 250 VAC 50 Hz	0 - 0.42 mA Max.
@ 120 VAC 60 Hz	0 - 0.23 mA Max.

TYPICAL LEAKAGE CURRENT 084SM

@ 250 VAC 50 Hz	0 - 10uA Max.
@ 120 VAC 60 Hz	0 - 5uA Max.

HIPOT RATINGS

LINE TO GROUND	2250 VDC
----------------	----------

TYPICAL APPLICATIONS

- ✓ AV equipment
- ✓ Medical equipment
- ✓ Office automation equipment
- ✓ Test and measurement/lab equipment
- ✓ Power Supplies

084S/084SM

SNAP-IN SINGLE STAGE FILTERED POWER ENTRY MODULE
(GENERAL PURPOSE & MEDICAL) WITH DUAL FUSE AND SWITCH

MODEL NO.	RATED CURRENT, A @ 40° C	TERMINAL OPTIONS	MAX. DIMENSIONS" (MM)		
		(QD) OUTPUT	WIDTH	(LENGTH)	HEIGHT
084S.00100.00	1	✓	1.29" (32.8)	2.68" (68)	2.17" (55.1)
084SM.00100.00	1	✓	1.29" (32.8)	2.68" (68)	2.17" (55.1)
084S.00300.00	3	✓	1.29" (32.8)	2.68" (68)	2.17" (55.1)
084SM.00300.00	3	✓	1.29" (32.8)	2.68" (68)	2.17" (55.1)
084S.00600.00	6	✓	1.29" (32.8)	2.68" (68)	2.17" (55.1)
084SM.00600.00	6	✓	1.29" (32.8)	2.68" (68)	2.17" (55.1)
084S.010000.00	10	✓	1.29" (32.8)	2.68" (68)	2.17" (55.1)
084SM.01000.00	10	✓	1.29" (32.8)	2.68" (68)	2.17" (55.1)
084S.01500.00	15	✓	1.29" (32.8)	2.68" (68)	2.17" (55.1)
084SM.01500.00	15	✓	1.29" (32.8)	2.68" (68)	2.17" (55.1)

084S(M) MECHANICAL OUTLINES (MM)

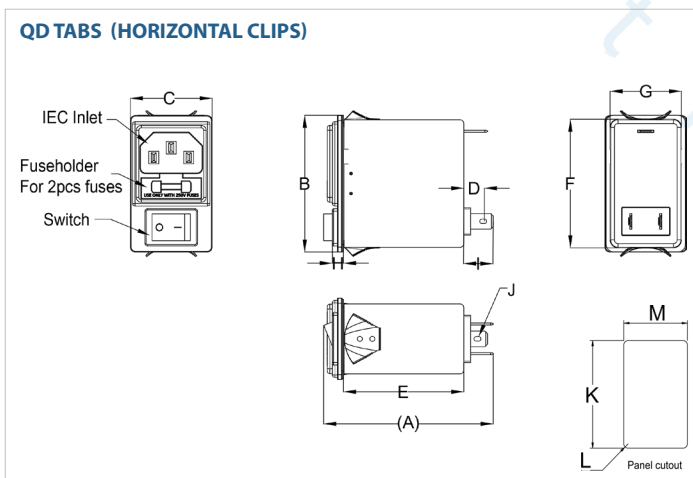

SERIES	(A)	B	C	D	E	F	G	H	I	J	K	L	M
QD TABS	2.68" (68)	2.17" (55.1)	1.29" (32.8)	0.33" (8.3)	1.90" (48.2)	2.02" (51.4)	1.11" (28.2)	0.18" (4.5)	0.46" (11.8)	0.25" (QD 6.3*0.8)	2.06" (52.4)	(4*R2)	1.13" (28.7)

TYPICAL TOLERANCE: +/-0.02" (0.50MM)

084S/084SM

SNAP-IN SINGLE STAGE FILTERED POWER ENTRY MODULE
(GENERAL PURPOSE & MEDICAL) WITH DUAL FUSE AND SWITCH

TYPICAL INSERTION LOSS, dB (50/50 Ohm)

084S INSERTION LOSS

Amps	Freq (MHz)	0.15	0.5	1	10	30
1	CM (dB)	41	55.01	52.28	48.94	38.21
	DM (dB)	19.96	34.43	47.43	67.85	60.64
3	CM (dB)	33.45	48.14	51.45	54.9	34.28
	DM (dB)	19.64	30.2	39.61	64.75	57.16
6	CM (dB)	23.07	35.8	42.96	59.8	48.4
	DM (dB)	19.49	29.72	33.55	59.96	42.37
10	CM (dB)	13.09	25.7	32.94	52.34	47
	DM (dB)	19.7	30.55	36.11	72.05	48.87
15	CM (dB)	6.7	19.31	25.43	44.97	40.03
	DM (dB)	19.67	30.63	36.57	67.16	47.75

084SM INSERTION LOSS

Amps	Freq (MHz)	0.15	0.5	1	10	30
1	CM (dB)	40.26	49.79	42.42	19.57	0.17
	DM (dB)	20.56	36.01	46.08	69.8	46.1
3	CM (dB)	32.6	43	41.92	19.19	0.2
	DM (dB)	19.91	32.73	41.56	53.93	47.94
6	CM (dB)	22.23	30.49	32.96	24.17	13.08
	DM (dB)	19.54	30.94	37.81	46.69	43.39
10	CM (dB)	11.98	20.1	22.86	17.75	11.2
	DM (dB)	19.65	30.82	37.26	38.67	33.11
15	CM (dB)	6.56	13.91	16.43	11.72	5.03
	DM (dB)	19.57	30.72	37.15	37.22	31.16