

PENMOUNT PM6601 CONTROL BOARD DATASHEET

Version 1.3
13/Mar/2020

Table of contents

Table of contents	2
Revision history	3
1.0 Introduction	4
2.0 Specifications	5
3.0 Mechanical Drawing	6
3.1 Mechanical size	6
3.2 Touch line pin definition.....	7
3.3 Interface pin definition	8
3.4 Connector Drawing.....	12
4.0 Drivers and utilities.....	13
4.1 Drivers.....	13
5.0 Others.....	14
5.1 ROHS compliance	14
5.2 Noise protection.....	14

Revision history

Rev.	Date	By	Summary	Remark
1.0	2019/8/21	Ken Hsu	New Release	
1.1	2019/9/4	Ken Hsu	Correct item 4.1 Drivers description	
1.2	2020/3/2	Ken Hsu	Changed AMT Resistive Multi-Touch Solutions to Resistive Multiple Touch	
1.3	2020/3/13	Ken Hsu	Changed PenMount PM6020 Controller IC to PenMount P2-10 Controller IC	

1.0 Introduction

The PenMount PM6601 control board is a high specification (Resistive Multiple Touch) touch panel controller product introduced by PenMount. The PenMount PM6601 can be applied in the consumer, commercial and industrial fields.

The PenMount PM6601 provides four types of interfaces, USB, I²C, UART, RS232 and supports touch panels sizes up to 12.1” . The PenMount PM6601 also supports a wide range of operating systems such as Windows and Linux.

Resistive Multiple Touch combine the advantages of resistive touch panels with multi-touch gestures through a matrix panel design with multiple resistive circuit grids 10mm -13mm in width to enable the detection of multiple analog signals. This allows single touch line drawing, multi-point operation, and two-finger gestures in Windows and Linux.

There are four connectors on this board: 80 Pins ZIF connectors for Resistive Multiple Touch screen FPC cables, one USB connector for 4-pin USB cable (optional) , and one I²C/UART connector for 7-pin I²C cable (optional) , and one RS232 connector for 5-pin RS232 cable (optional)

2.0 Specifications

Parameter		Feature
Touch Screen		For Resistive Multiple Touch screen
Controller part number		PenMount P2-10 Controller IC
Supporting touch panel size		≤ 12.1" (Pitch ~ 13mm)
Interface	USB	Full-speed, 12Mbps
	UART/RS232	38400 baud rate / 8bit data / non parity / one stop bit / non-PnP
	I ² C	Slave, 400 kHz
Resolution		1024 x 1024 (Typical)
Sampling rate	One finger touch	200Hz(Typical)
	Two fingers touch	180Hz(Typical)
Operating voltage		+5Vdc, ±5 %
Finger resolution		> two Pitches
Power consumption	Working mode	26.0mA @ 5Vdc
	Idle mode	13.0mA @ 5Vdc
	Sleep mode	2.0mA @ 5Vdc
Operating temperature		-40°C ~ +85°C
Storage temperature		-40°C ~ +85°C
Relative humidity range		95% RH at 60°C. RH Non-condensing
Electro Static Discharge (ESD)		Air Discharge 15KV , Contact Discharge 8KV
Watchdog Timer		Support WDT function through firmware programming

Note :

Power consumption and sample rate will vary according to different firmware versions.

3.0 Mechanical Drawing

3.1 Mechanical size

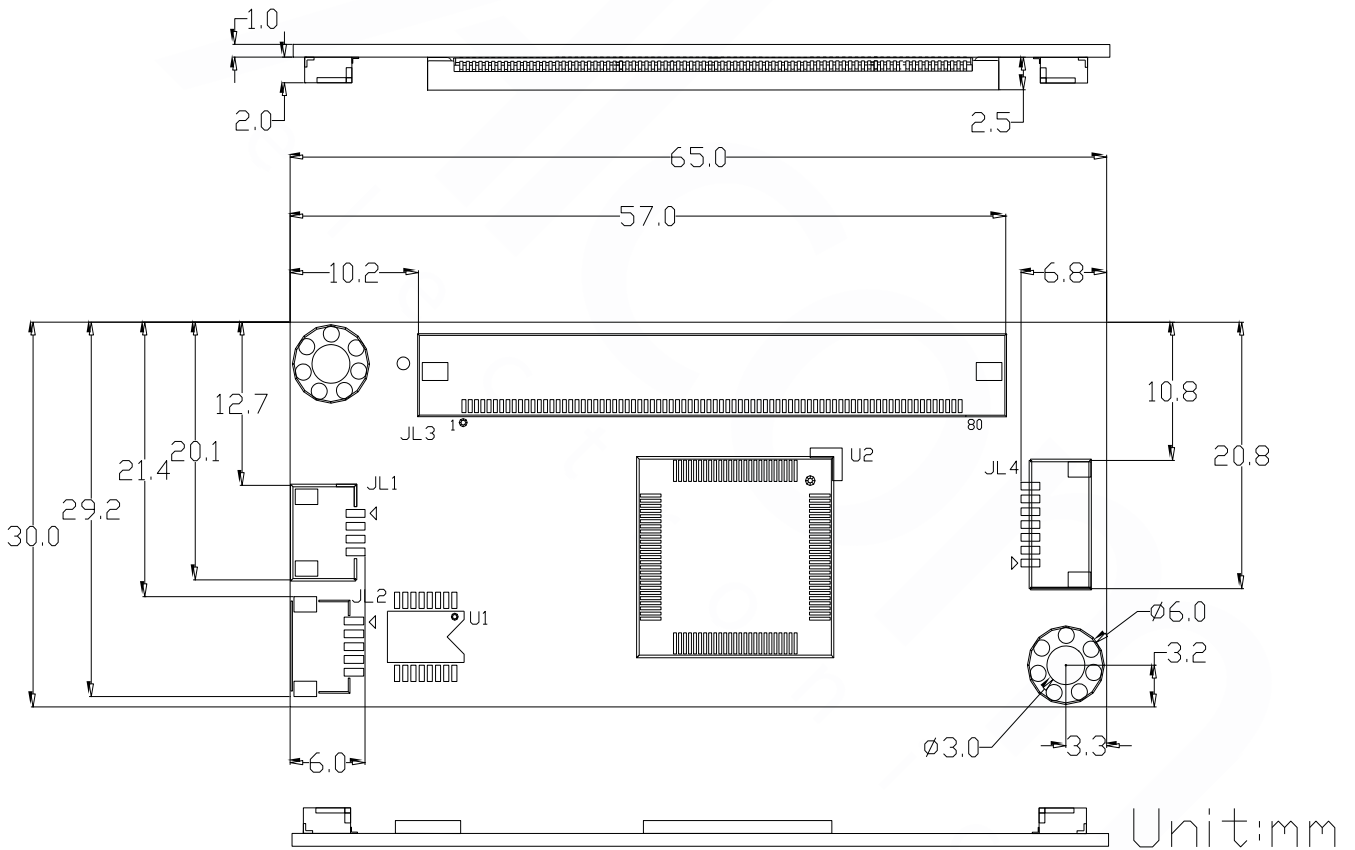
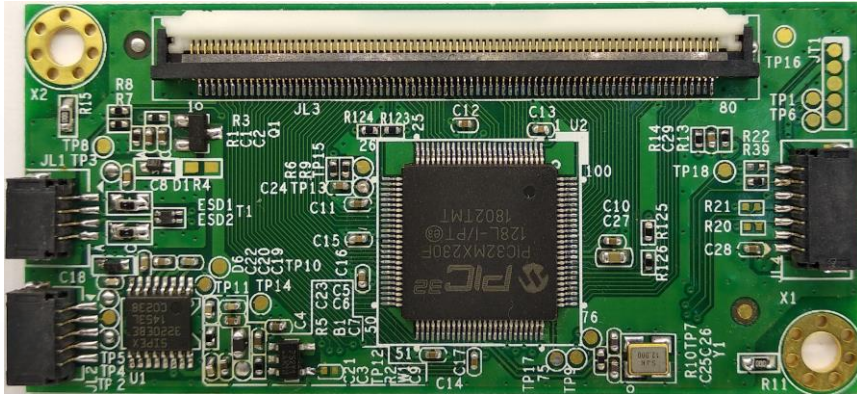

3.2 Touch line pin definition

JL3 80Pin ZIF , PH 0.5mm ; ACES 50520-08001-001							
PIN	Description	PIN	Description	PIN	Description	PIN	Description
1	Ground	21	GPIO / ADC	41	GPIO / ADC	61	GPIO / ADC
2	NC	22	GPIO / ADC	42	GPIO / ADC	62	GPIO
3	NC	23	GPIO / ADC	43	GPIO / ADC	63	GPIO
4	GPIO	24	GPIO / ADC	44	NC	64	GPIO
5	GPIO	25	GPIO / ADC	45	NC	65	GPIO
6	GPIO	26	GPIO / ADC	46	NC	66	GPIO / ADC
7	GPIO	27	GPIO / ADC	47	GPIO / ADC	67	GPIO / ADC
8	GPIO	28	GPIO / ADC	48	GPIO / ADC	68	NC
9	GPIO	29	GPIO / ADC	49	GPIO / ADC	69	NC
10	GPIO	30	GPIO / ADC	50	GPIO / ADC	70	NC
11	GPIO	31	GPIO / ADC	51	GPIO / ADC	71	GPIO / ADC
12	GPIO	32	GPIO / ADC	52	GPIO / ADC	72	GPIO / ADC
13	GPIO / ADC	33	GPIO / ADC	53	GPIO / ADC	73	GPIO / ADC
14	GPIO / ADC	34	GPIO / ADC	54	GPIO / ADC	74	GPIO / ADC
15	GPIO	35	GPIO / ADC	55	GPIO	75	GPIO / ADC
16	GPIO	36	GPIO / ADC	56	GPIO / ADC	76	GPIO / ADC
17	GPIO	37	GPIO / ADC	57	GPIO	77	GPIO / ADC
18	GPIO / ADC	38	GPIO / ADC	58	GPIO	78	NC
19	GPIO / ADC	39	GPIO / ADC	59	GPIO / ADC	79	NC
20	GPIO / ADC	40	GPIO / ADC	60	GPIO / ADC	80	Ground

3.3 Interface pin definition

PM6601 includes USB/I2C/UART/RS232 communication interfaces, intends to maximize application flexibility and reliability, and minimizes cost through elimination of external components.

JL1 / 4PIN / ACES 50224-00401-001						
PIN NO.	USB	Description	Min	Typ	Max	Unit
1	VCC	Positive power supply	4.75	5	5.25	V
2	D-	D- pin of internal USB transceiver		3.3		V
3	D+	D+ pin of internal USB transceiver		3.3		V
4	GND	Ground		0		V

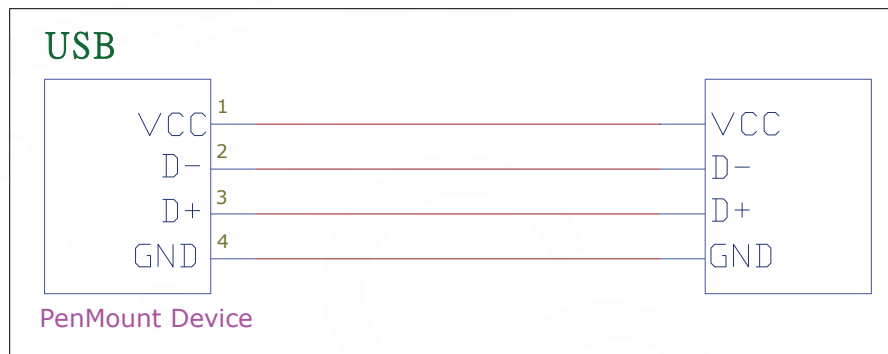

Figure1 USB interface

JL2 / 5PIN / ACES 50224-00501-001						
PIN NO.	RS232	Description	Min	Typ	Max	Unit
1	VCC	Positive power supply	4.75	5	5.25	V
2	RXD	RS232 receive	-25		+25	V
		input threshold low	0.8	1.5		
		input threshold high		1.8	2.4	
3	TXD	RS232 transmit	-13.2		+13.2	V
		output Voltage low			0.4	
		output Voltage high	4.4	4.9		
4	GND	Ground		0		V
5	GND	Ground		0		V

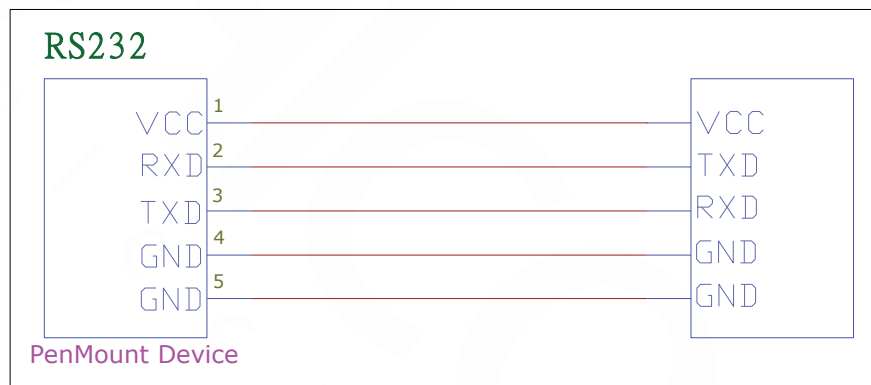

Figure2 RS232 interface

JL4 / 7PIN ; ACES 50224-00701-001			
PIN NO.	SYMBOL	PIN ASSIGNMENT	
		I ² C	UART
1	VCC	VCC	VCC
2	GND	Ground	Ground
3	SCL / RXD	SCL	RXD
4	SDA / TXD	SDA	TXD
5	nRESET	N.C.	N.C.
6	nDETECT	N.C.	Low
7	nINT	nINT	Low

PIN NO.	Type	Description	Min	Typ	Max	Unit
VCC	P	Positive power supply	4.75	5	5.25	V
GND	P	Ground		0		V
SCL	I/O	Serial clock line for I2C. Open drain requires external pull-up to 3.3V.		3.3		V
SDA	I/O	Serial data line for I2C. Open drain requires external pull-up to 3.3V		3.3		V
RXD	I	UART receive		3.3		V
TXD	O	UART transmit		3.3		V
nRESET	I	Open-drain and active low to reset PM6601 and must be driven low for 5 μ s (typical) to be valid. Leave the pin unconnected if not used.				V
nDETECT	I	Pull low when selecting UART interface float when selecting I2C interface		0		V
nINT	O	Processor Interrupt. This pin is active low, open drain requires external pull-up to 3.3V.		3.3		V

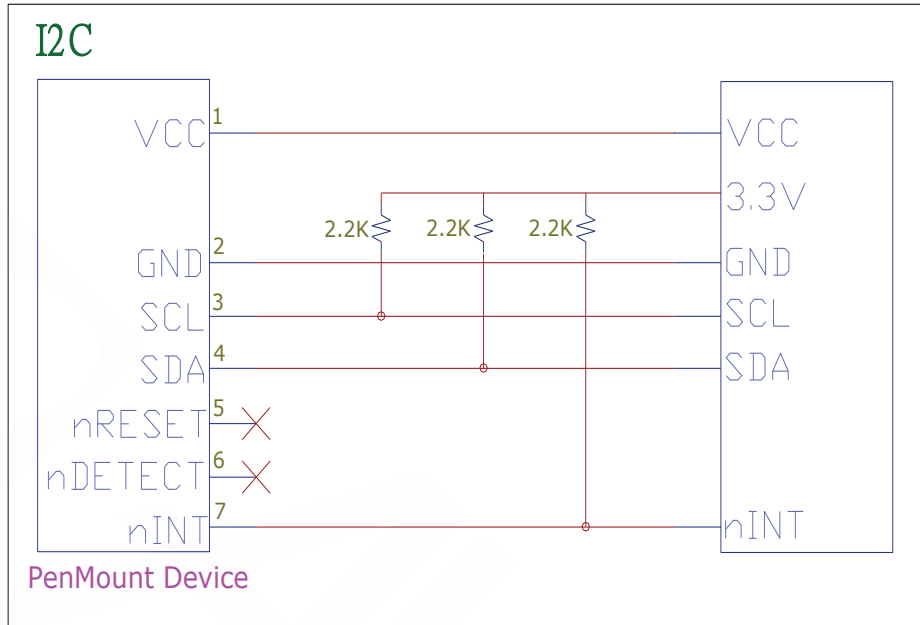

Figure2 I²C interface

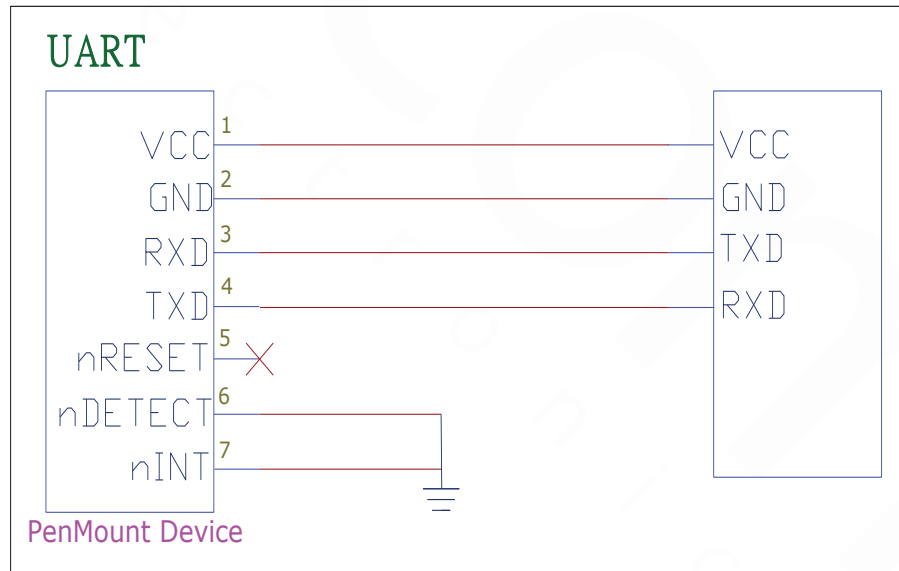
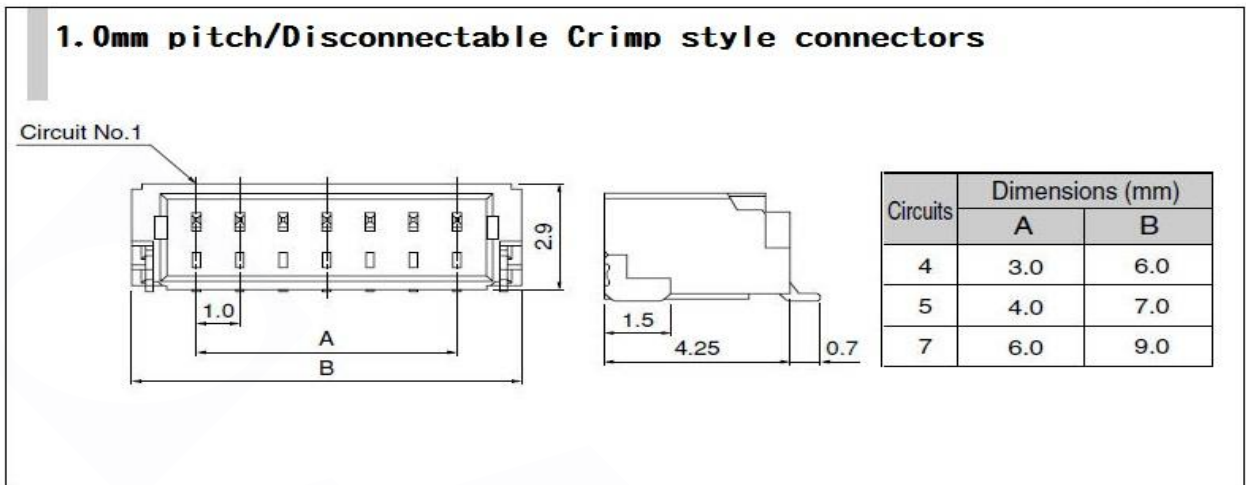

Figure3 UART interface

3.4 Connector Drawing



4.0 Drivers and utilities

4.1 Drivers

For USB

- Windows 7, 8, 10
- Windows 7, 8, 10: Inbox driver.
- Windows XP: Single touch, PenMount Device Driver.
- Windows CE: Single touch, PenMount Device Driver.
- Linux: Inbox driver after kernel 3.4.
- Other Platforms: by request.

For UART/ RS-232

- Windows 7, 8, 10: Dual touch, PenMount Device Driver.
- Windows XP: Single touch, PenMount Device Driver.
- Windows CE: Single touch, PenMount Device Driver.
- Linux: Inbox driver after kernel 3.4.
- Other Platforms: by request.

For I²C

- Linux: With NDA, we provide a source code example of our I2C communication protocol for reference.
- Windows CE: With NDA, we provide a driver and SDK example of our I2C communication protocol for reference.

(Provide source code for integration if any)

Note:

All drivers and utilities are available on PenMount websites. Please contact us for further information.

5.0 Others

5.1 ROHS compliance

This control board is ROHS compliant

5.2 Noise protection

To achieve good noise interference protection capabilities, PenMount requires paired interface cables possess comprehensive EMI shielding.

The cable should have a woven or spirally copper shield with 360 ° shield coverage
 The shield must be terminated to the receptacle and be connected to ground plane carefully.

Below is an example for 4-pin USB cable diagram. For other implementation, please follow the same design rules.

