

REV.	DESCRIPTION	DRAWN	DATE
1	INITIAL RELEASE	FROS	2022/07/18

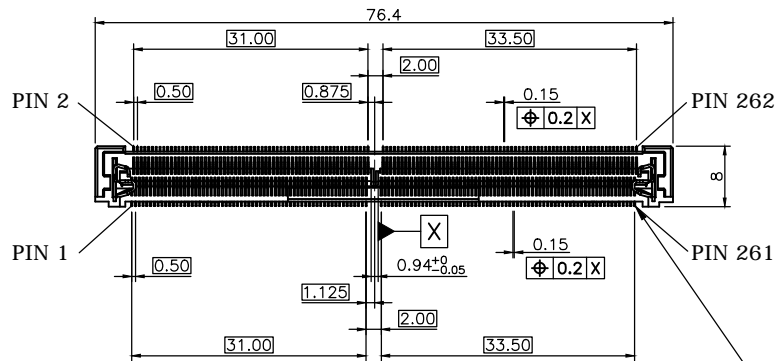

SPECIFICATION:

1. ELECTRICAL
 - 1.1 Current Rating: 0.6A per pin
 - 1.2 Voltage Rating: 25V AC
 - 1.3 Contact Resistance: 60mΩ max.
 - 1.4 Insulation Resistance: 100MΩ
 - 1.5 Dielectric Withstanding Voltage: 500VAC
2. MECHANICAL
 - 2.1 Durability: 50 Cycle
 - 2.2 Insertion Force: 59.8N max.
 - 2.3 Extraction Force: 44.6N max.
3. ENVIRONMENTAL
 - 3.1 Operating temperature range: -55°C~+85°C
 - 3.2 Storage temperature range: -55°C~+85°C
4. SOLDER ABILITY
 - 4.1 Recommended IR-Reflow Temperature: 260°C

DATE CODE: YWWD

Y: YEAR
 WW: WEEK (01~52)
 D: DAY (1~7)

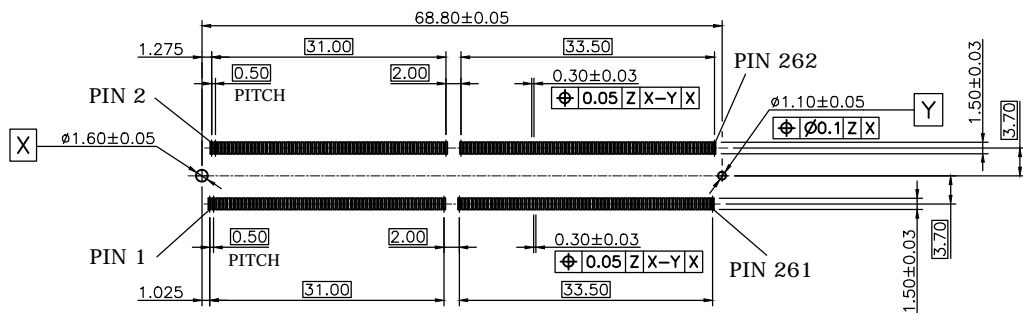
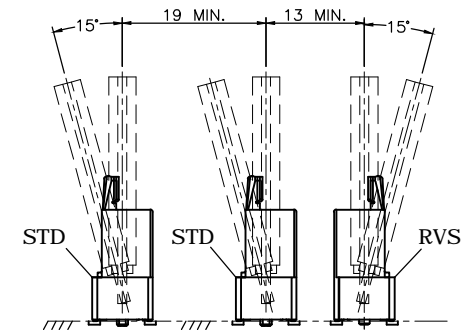
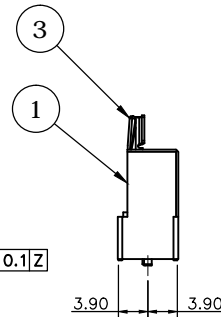
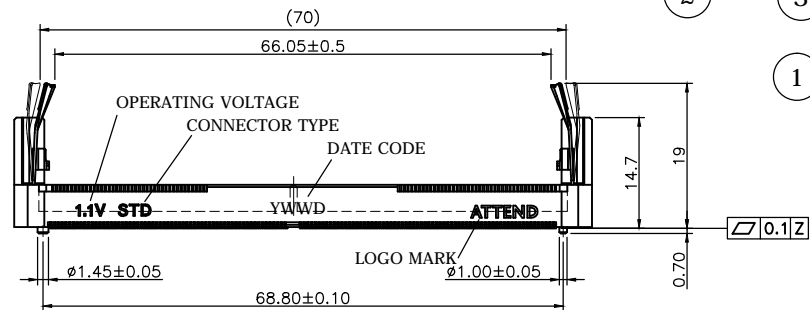

RECOMMENDED SOCKET MOUNTING LAYOUT

3	LATCH	STAINLESS STEEL	
2	CONTACT	PHOSPHOR BRONZE, GOLD FLASH	
1	HOUSING	LCP, UL94V-0, BLACK	
NO.	PART NAME	DESCRIPTION	
UNLESS OTHERWISE SPECIFIED TOLERANCE			
UNIT:	DECIMAL	LINEAR	ANGLES
mm	X.	±0.50	±5°
	X.X	±0.25	±3°
	X.XX	±0.12	±1°
www.attend.com.tw			
DRAWN	Fros	2021/12/03	DRAWN NAME:
CHECKED	Tim	2021/12/03	DDR5 SODIMM Socket, Vertical 19H, STD, G/F, Black, Tray
APPROVED	Ken	2021/12/03	PRODUCT NO. 126B-190A00
SCALE	1/1	SHEET 1/1	SIZE A4
FILE NAME	126B-190A00_B_1		

RECOMMENDED PCB LAYOUT (TOP VIEW)
 GENERAL TOLERANCE: ±0.05mm

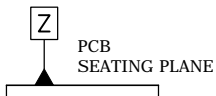

REV.	DESCRIPTION	DRAWN	DATE
1	INITIAL RELEASE	FROS	2021/03/23

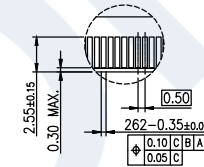
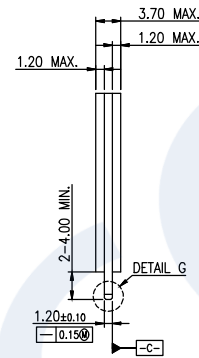
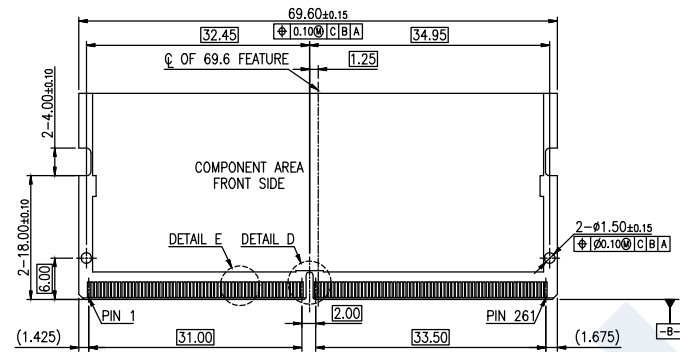

DETAIL E
SCALE 2:1

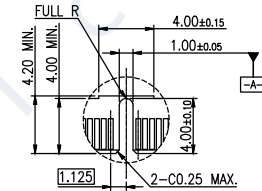

DETAIL D
SCALE 2:1

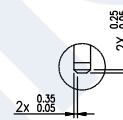
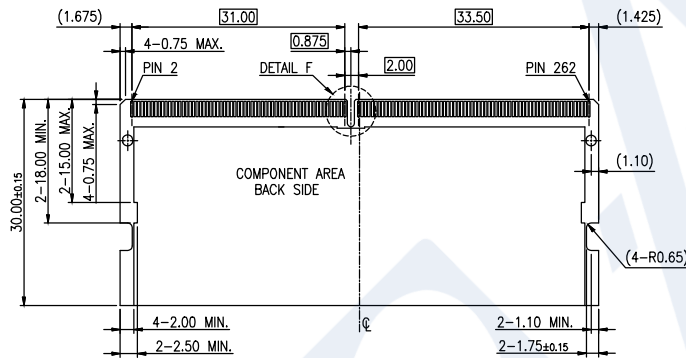

DETAIL G
SCALE 2:1

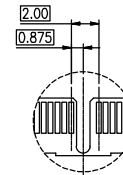

DETAIL F
SCALE 2:1

RECOMMEND MODULE CONFIGURATION

UNLESS OTHERWISE SPECIFIED TOLERANCE			
UNIT:	DECIMAL	LINEAR	ANGLES
mm	X.	±0.50	±5°
	X.X	±0.25	±3°
	X.XX	±0.12	±1°





www.attend.com.tw

DRAWN	Fros	2021/03/23	DRAWN NAME:	262 PIN DDR5 SODIMM, 0.5MM PITCH PACKAGE	
CHECKED	Tim	2021/03/23	PRODUCT NO.		
APPROVED	Ken	2021/03/23	FILE NAME	126A-CARD_B_1	
SCALE	1.25	SHEET	1/1	SIZE	A4

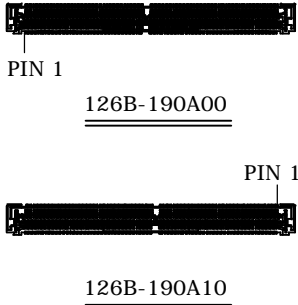
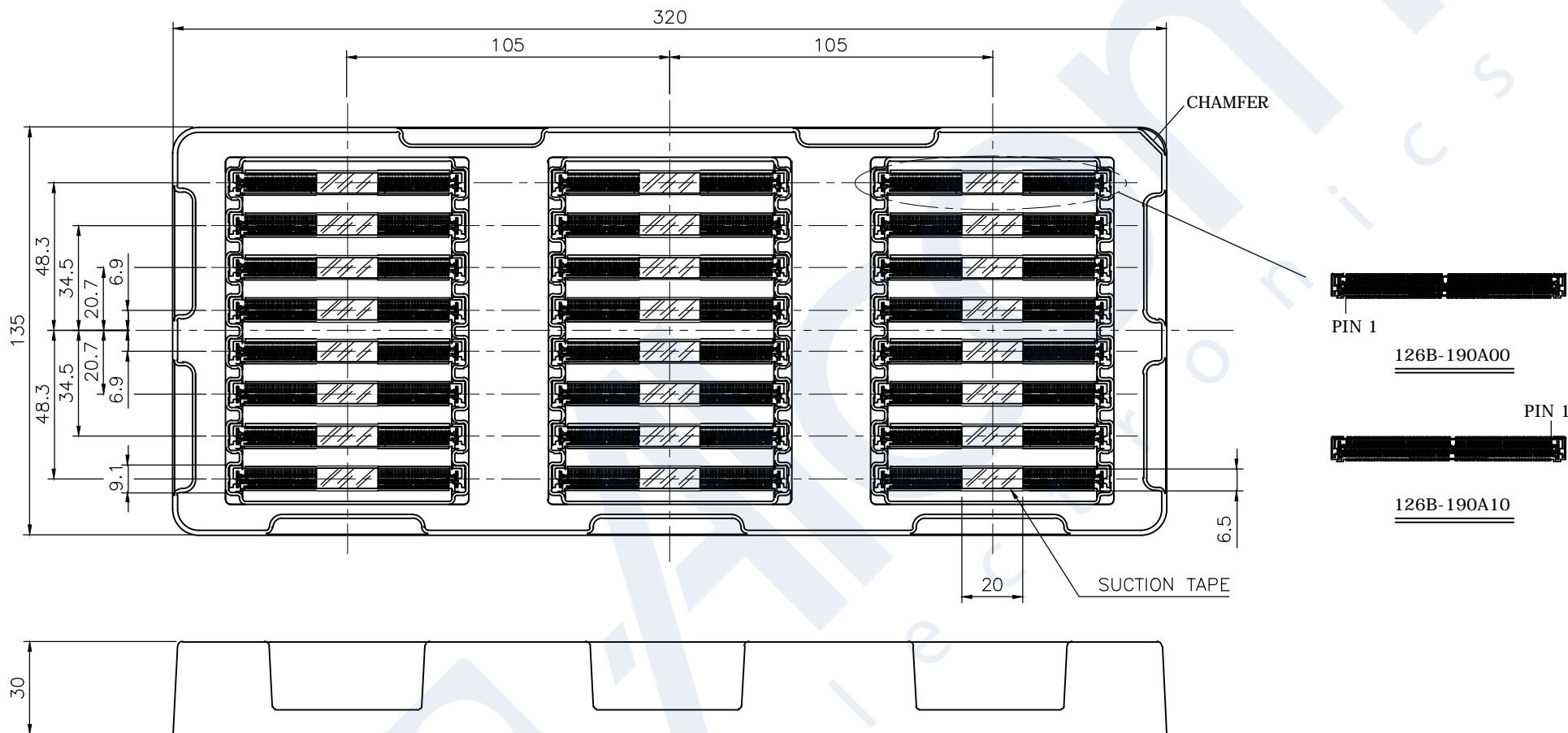
REV.	DESCRIPTION	DRAWN	DATE
1	Initial Release	TIM	2023/01/09



P/N	QTY/TRAY	INNER BOX	CARTON
126B-190A00	24	192	576
126B-190A10	24	192	576

UNLESS OTHERWISE SPECIFIED TOLERANCE					
UNIT:	DECIMAL	LINEAR	ANGLES		
mm	X.	±0.50	±5°	WWW.ATTEND.COM.TW DRAWN NAME: DDR5 SODIMM Socket, Vertical PACKAGING	
	X.X	±0.25	±3°		
	X.XX	±0.12	±1°		
DRAWN	Tim	2022/10/11	DRAWN NAME: DDR5 SODIMM Socket, Vertical PACKAGING		
CHECKED	Fros	2022/10/11			
APPROVED	Ken	2022/10/11	PRODUCT NO.	SEE TABLE	
	SCALE	SHEET	SIZE	FILE NAME	126B-190AX0_D_1
	1/2	1/1	A4		